

Introduction

Purpose

This manual provides network-specific information for Passport™ V12 systems at Irving Oil® stores that use the National Bankcard Services (NBS®) network.

IMPORTANT INFORMATION

Upgrading to Passport V12 requires advance notice to the NBS network that the site is implementing EMV® functionality on Passport. In this version, EMV functionality affects inside and outside transactions. At least two full days before the scheduled upgrade, advise the merchant to contact the Irving POS Representative that oversees the location and explain that the site is implementing an upgrade to Passport to enable EMV. The merchant should advise the Irving POS Representative of the date the upgrade is to take place and request that Irving prepare to enable EMV with appropriate parameter downloads on that date. Ask the merchant to let you know if the Irving POS Representative is unable or unwilling to make the necessary preparations for enabling EMV for the store. On the day of the scheduled upgrade, verify that the merchant or store manager has notified the Irving POS Representative of the need to prepare to enable EMV network communication. If the merchant or store manager has not notified the Irving POS Representative, call the Irving POS Representative on behalf of the merchant or store manager. Ask the representative if he can expedite enabling EMV functionality for the store within four hours. If the representative indicates he can prepare for enabling EMV on the network within the next four hours, continue with the upgrade. Otherwise, consult the merchant or store manager regarding your options, which are:
Upgrade without enabling EMV and return later for the PDL Download to enable EMV.
Arrange a later date for the upgrade, after the network has sufficient time to enable EMV.

Intended Audience

This manual is intended for merchants, store managers, cashiers, and Passport-certified Gilbarco® Authorized Service Contractors (ASC).

Note: Leave this manual at the site for the manager's reference. This manual is available for download by a certified Passport ASCs on Gilbarco Online Documentation (GOLDSM) library.

REVIEW AND FULLY UNDERSTAND THIS MANUAL BEFORE BEGINNING THE UPGRADE.

Table of Contents

Topic	Page
Introduction	1
What's New in Passport V12 at Irving Oil Stores	4
What's New in Passport V11 at Irving Oil Stores	4
Site Configuration Programming	6
Accepting Magnetic Stripe Contactless Inside	16
Requesting Card Configuration Download	17
Requesting EMV PDL Download	19
Passport Loyalty Configuration for Irving Rewards Loyalty Programs	20
Irving Oil Discount Group for Irving Debit Pay Cards	28
Passport Auxiliary Network Configuration for Irving Debit Pay	29
EBT Food and EBT Cash Tenders	32
Network Reports	33
Network Journal Report	43
CWS Network Functions	46
Appendix A: Cenex® Fuel Product Codes	48
Appendix B: Upgrading to Passport V12	50
Appendix C: Network Topology at Irving Sites	51

Related Documents

Document Number	Title	GOLD Library
MDE-5025	Passport V9+ System Reference Manual	Passport
MDE-5167	Gilbarco Deployment Service (GDS) Startup and Service Manual	Passport
MDE-5266	What's New in Passport Version 11	Passport
MDE-5470	What's New in Passport Version 12	Passport
MDE-5514	Passport EDH (NBS) V10.32 Implementation Guide for PA-DSS 3.2	Passport

Abbreviations and Acronyms

Term	Description
AID	Application Identifier
ASC	Authorized Service Contractor
BIOS	Basic Input/Output System
BOS	Back Office System
CAPK	Certificate Authority Public Keys
COM	Communication
CRIND®	Card Reader in Dispenser
CWS	Cashier Workstation
DSL	Digital Subscriber Line
EBT	Electronic Benefits Transfer
EDH	Enhanced Dispenser Hub

Term	Description
EMV	Europay®, MasterCard®, and Visa®
GOLD	Gilbarco Online Documentation
MWS	Manager Workstation
NBS	National Bankcard Services
PA-DSS	Payment Application Data Security Standard
PDL	Parameter Download
PPU	Price per Unit
RAS	Remote Access Service
TCP/IP	Transmission Control Protocol/Internet Protocol
TLS	Transport Layer Security
VSAT	Very Small Aperture Terminal

Technical Support

If you are a store manager or merchant and you need assistance with Passport, call Gilbarco at 1-800-800-7498.

If you are an ASC and need to verify RAS connection or activate a Passport feature, call Gilbarco at 1-800-800-7498. If you need assistance with an upgrade or installation issue, call Gilbarco at 1-800-743-7501. Be prepared to provide your ASC ID.

To contact the NBS Help Desk, call at 1-800-827-4634.

To contact the EchoSatSM Help Desk, call at 1-800-393-3246.

Firewall Router

The RV042 Passport router is no longer supported in Passport V12 and higher. Sites must install either Gilbarco's Secure Zone Router [(SZR) powered by Acumera], or a Gilbarco-certified Managed Network Service Provider solution (MNSP). Contact the major oil representative for the location(s) and details on which providers are approved by the brand. Acumera hardware can be purchased from Gilbarco. Contact the brand-approved MNSPs for details on ordering their networking equipment.

Network Data Retention

By default, the Passport system's network database saves all transaction details for 30 days, which means Passport purges network transaction details older than 30 days. This network setting can be changed by updating the "Days to Keep" field value (refer to table on [page 8](#)). The Days to Keep field can accept values between 30 and 90 days, inclusive.

What's New in Passport V12 at Irving Oil Stores

Passport V12 Core Feature Enhancements

For information on any of the new core features, refer to *MDE-5470 What's New in Passport Version 12*.

EMV Outdoor

Passport V12.03 is the first release for NBS Irving to support EMV chip card compliance outside at the dispenser. The customer and store associate experience changes greatly with introduction of EMV. Customers using a credit or debit card with an embedded microchip must insert the card into the chip reader on the dispenser outside, and leave it inserted until the chip reader displays instructions to remove the card. Customers at the dispenser will notice new prompts related to EMV.

Enabling EMV outside at the dispenser requires Gilbarco FlexPay™ II, FlexPay IV, or FlexPay IV Retrofit Kit for Wayne® dispensers. Each of these Gilbarco platforms also require CRIND via TCP/IP.

What's New in Passport V11 at Irving Oil Stores

The following features have been updated or are new for the Irving Oil stores:

V11 Core Feature Enhancements

The following is a high-level description of core Passport features introduced in V11. For more information on any of the new features, refer to *MDE-5266 What's New in Passport Version 11*.

EMV Support on Inside Transactions

Beginning with V11.01, Passport supports EMV for inside transactions in the U.S. Enabling EMV inside may require new PIN pads or new PIN pad software. EMV-capable PIN pads are VeriFone® MX915, Ingenico® iSC250, and Ingenico iPP320. In addition, the ASC can change PIN pad configurations in **MWS > Set Up > Register > Register Set Up**. The ASC must update network configuration parameters in **MWS > Set Up > Network > NBS** for EMV inside transactions.

Tender Keys in CWS

The CWS reflects a basic change beginning with V11.01. A new tender key, labeled Card, replaces the Credit and Debit tender keys. The cashier selects the Card tender key when the customer presents a credit, debit, or prepaid card for payment. This change is made because EMV chip cards can contain multiple EMV applications which support credit and debit payment. Passport does not know the specific payment application to use for the transaction until after the cashier begins tendering the transaction, the customer inserts an EMV chip card, and the PIN pad communicates with the chip on the card. Passport determines the card type and Passport logs the transaction based on this determination. Credit and Debit tenders continue to appear on Accounting reports as before.

Assigning Product Codes

The Passport system supports PCATS Payment System Product Codes for fuel and dry stock items. The Passport system transmits the product codes assigned to fuel and dry stock items when completing transactions with the network. It is important to assign the correct product code to fuel grades and dry stock items, as NBS reserves the right to reject transactions that are transmitted using incorrect product codes.

IMPORTANT INFORMATION
If fuel product codes are set up incorrectly, cards with grade restrictions will not be approved for fuel sales. Use care in assigning fuel grades in MWS > Set Up > Forecourt > Forecourt Installation to ensure correct product code assignment.

Site Configuration Programming

IMPORTANT INFORMATION
Install and run the Enhanced Dispenser Hub (EDH) before you start network configuration.

Note: To establish communication with NBS, the Passport Site Configuration must be programmed correctly.

To program Site Configuration, proceed as follows:

- 1 From the MWS main menu, select **Set Up > Network Menu**.

Figure 1: Set Up Menu



- 2 Select **Network Menu**. The Network menu screen opens.
- 3 Select **NBS**. The following options are displayed:
 - Site Configuration
 - Card Configuration Download
 - EMV PDL Download
 - Fuel Discount Configuration

- To program network configuration for the site, select **Site Configuration**. The NBS Network Site Parameters screen opens.

Figure 2: Site Configuration - Page 1 Tab

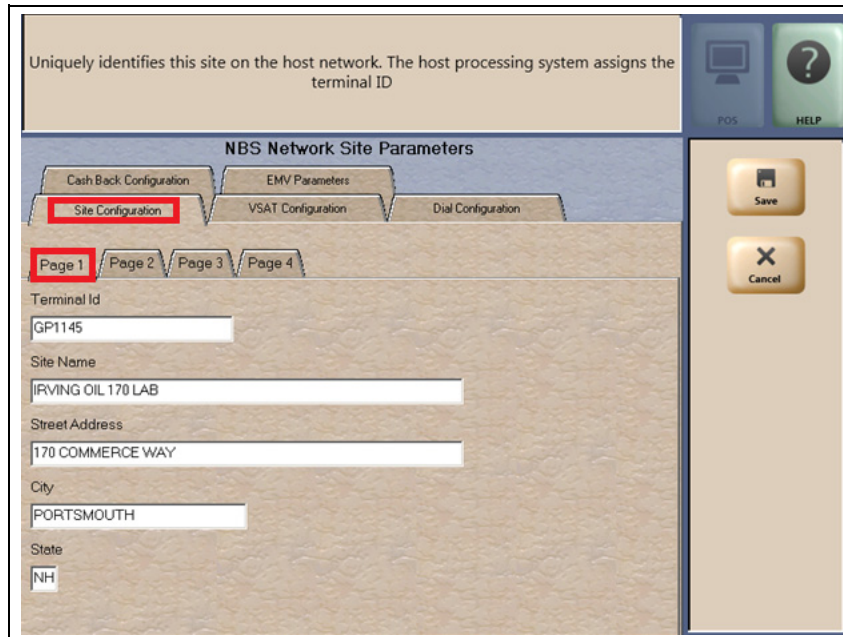

- Select the **Site Configuration - Page 1** tab.

The following table lists the fields on the Site Configuration - Page 1 tab:

Field	Description
Terminal ID	Uniquely identifies the site with the network. NBS provides this value.
Site Name	The station name for the store.
Street Address	The address of the store. This value is supplied by the store.
City	The city in which the store is located. This value is provided by the store.
State	The state in which the store is located. This value is provided by the store.

6 Select the **Site Configuration - Page 2** tab.

Figure 3: Site Configuration - Page 2 Tab

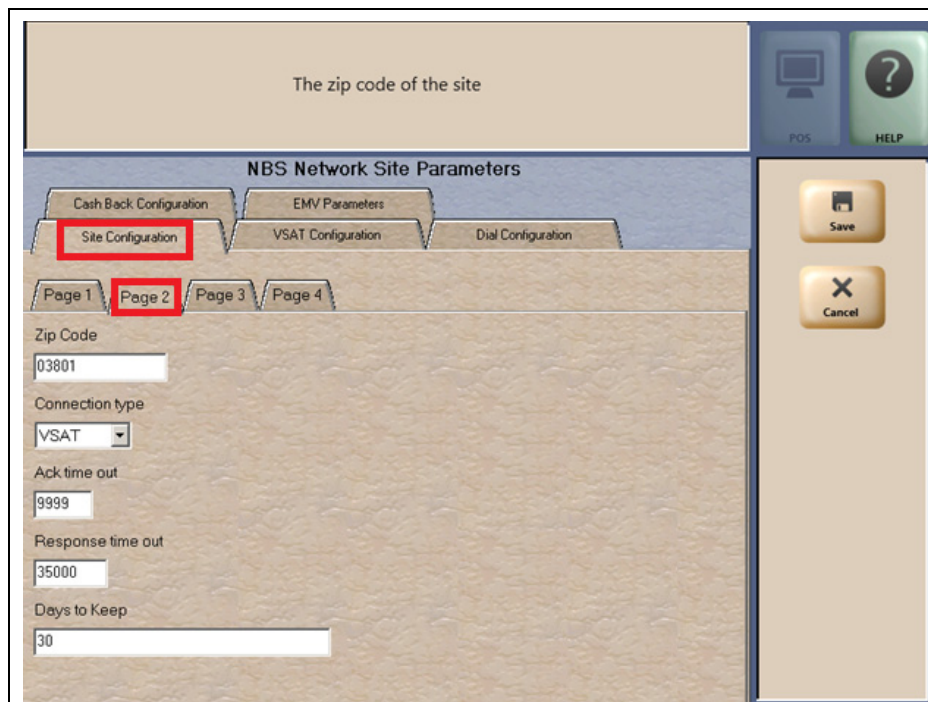

The following table lists the fields on the Site Configuration - Page 2 tab:

Field	Description
ZIP Code	The ZIP code in which the store is located. This value is provided by the store.
Connection type	Indicates the method the store uses to connect to the NBS network. The available options are VSAT(IP) and Dial .
Ack time out (see Note 1)	Indicates the time Passport system waits for a response from the NBS network for an authorization request before cancelling the request. The Passport system attempts to send the authorization request up to three times before cancelling the request. The unit of measurement is milliseconds.
Response time out (see Note 1 and Note 2)	Indicates the time out after the Passport system receives an NBS network acknowledgment (no retries within the same COM session). The Passport system makes three attempts. The unit of measurement is milliseconds.
Days to Keep	Indicates the number of days worth of network transaction information to keep in the database. The accepted values are between 30 and 90 days, inclusive.

Notes: 1) This value comes from the NBS network and cannot be edited.
 2) The ASC must validate these values with the NBS network to ensure that the store is using the correct values. The default value may not be correct.

- 7 After completing all fields on the Page 2 tab, select the **Page 3** tab.

Figure 4: Site Configuration - Page 3 Tab

Configuration Name. First character must be alpha

NBS Network Site Parameters

Cash Back Configuration EMV Parameters
 Site Configuration VSAT Configuration Dial Configuration

Page 1 Page 2 Page 3 Page 4

Configuration Name
 EMVGP01

EMV Configuration
 debitmvconf

EMV Outdoor Configuration
 afdemvconf

EMV Keys
 NBSPubKeysAllBrands

Print store copy of the receipt inside
 Yes

Save Cancel

The following table lists the fields on the Site Configuration - Page 3 tab:

Field	Description
Configuration Name	Indicates the name of the card configuration file the NBS network keeps for this store. This value is provided by the NBS network. V11.02 uses the configuration name CHSGP1, V11.04 uses the configuration name ECHSGP1, V12.03 uses EMVGP01 . <i>Note: The ASC must validate these values with the NBS network to ensure that the store is using the correct values. The default value may not be correct.</i>
EMV Configuration	Indicates the name of the EMV configuration file the NBS network keeps for this store. This value is provided by the NBS network. This is an editable field. Default value: debitmvconf . <i>Note: The ASC must validate these values with the NBS network to ensure that the store is using the correct values. The default value may not be correct.</i>
EMV Outdoor Configuration	Indicates the name of the EMV Outdoor configuration file the NBS network keeps for this store. This value is informed by the NBS network. This is an editable field. Default value is afdemvconf . <i>Note: The ASC must validate the value with the NBS network to ensure that the store is using the correct value. The default value may not be correct.</i>
EMV Keys	Indicates the name of the EMV Keys file the NBS network keeps for this store. This value is provided by the NBS network. This is an editable field. Default value: NBSPubKeysAllBrands . <i>Note: The ASC must validate these values with the NBS network to ensure that the store is using the correct values. The default value may not be correct.</i>
Print store copy of the receipt inside	If set to No, Passport does not print a store copy of a receipt for a transaction completed with the NBS network. Defaults to Yes .

8 After completing all fields on the Page 3 tab, select the **Page 4** tab.

Figure 5: Site Configuration - Page 4 Tab

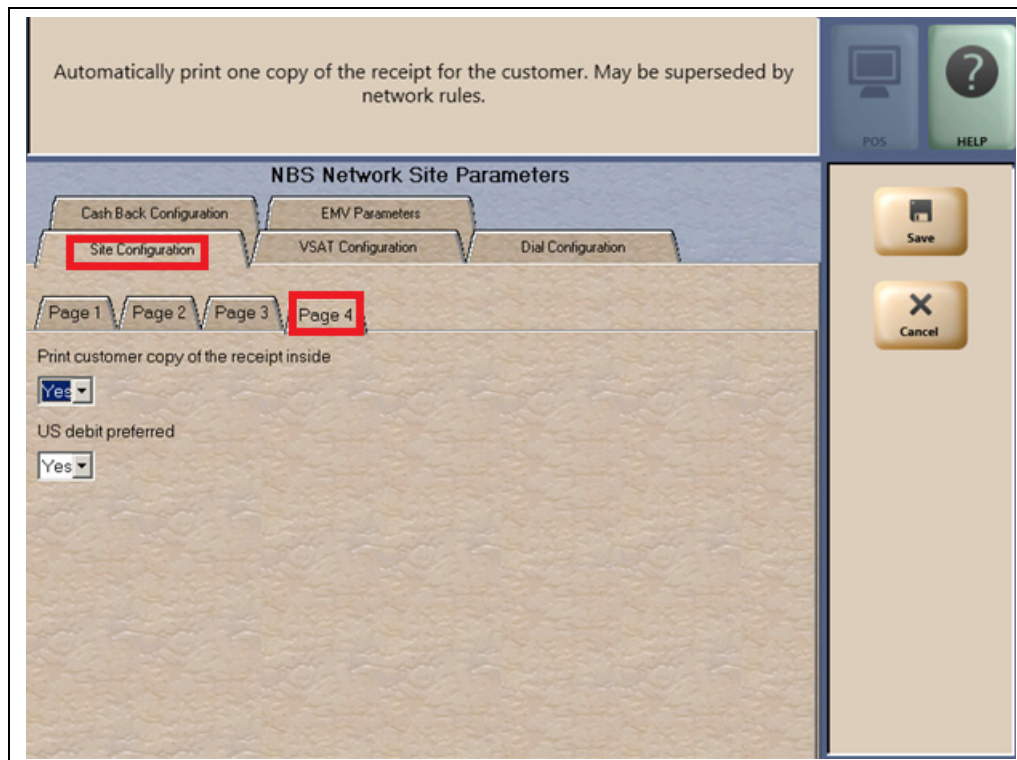

The following table lists the fields on the Site Configuration - Page 4 tab:

Field	Description
Print customer copy of the receipt inside	If set to No, Passport does not print a customer copy of a receipt for a transaction completed with the NBS network. Defaults to Yes.
US debit preferred	<ul style="list-style-type: none"> If set to Yes, when the customer presents an EMV card that contains both US Common and International Debit Application Identifiers (AID), Passport displays or uses the US Common Debit AID. If set to No, when the customer presents an EMV card that contains both US Common and International AID, Passport displays or uses the International Debit AID. If the card contains only one debit AID, Passport displays or uses it irrespective of the setting for this field. Default value is Yes .

- 9 Refer to the Connection type field on the **Site Configuration > Page 2** tab. If the Connection type field is set to Dial, then proceed to step 11 on [page 12](#). Otherwise, select the **VSAT Configuration** tab.

Figure 6: VSAT Configuration Tab

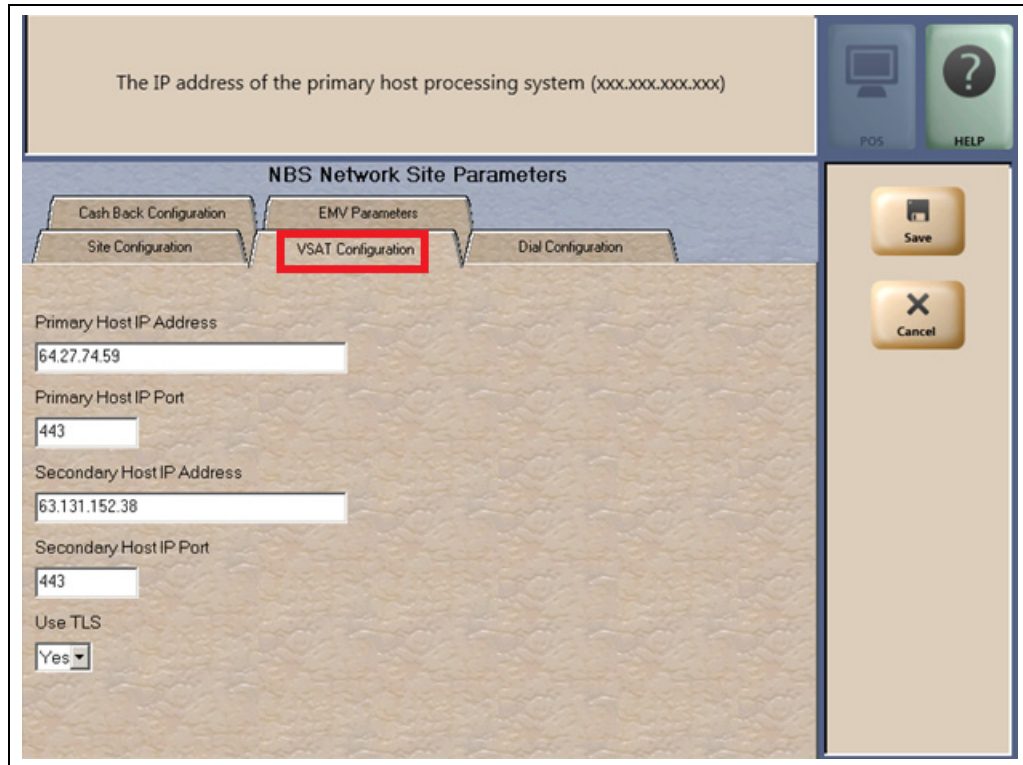

The following table lists the fields on the VSAT Configuration tab:

Field	Description
Primary Host IP Address	The IP address of the primary NBS processor for this store.
Primary Host IP Port	The port number for the primary NBS processor for this store.
Secondary Host IP Address	The IP Address for the secondary NBS processor for this store.
Secondary Host IP Port	The port number for the secondary NBS processor for this store. By default, the value is not set.
Use TLS	Transport Layer Security (TLS) is the protocol that offers enhanced security through connection. Defaults to Yes . Note: For EMV-enabled sites, it is mandatory to set YES.

Note: The NBS network provides information for all fields on the VSAT Configuration tab.

- 10 After completing all fields on the VSAT Configuration tab, proceed to step 13 on [page 14](#).

- If the Connection type selected on the **Site Configuration - Page 2** tab is Dial, select the **Dial Configuration** tab.

Figure 7: Dial Configuration - Page 1 Tab

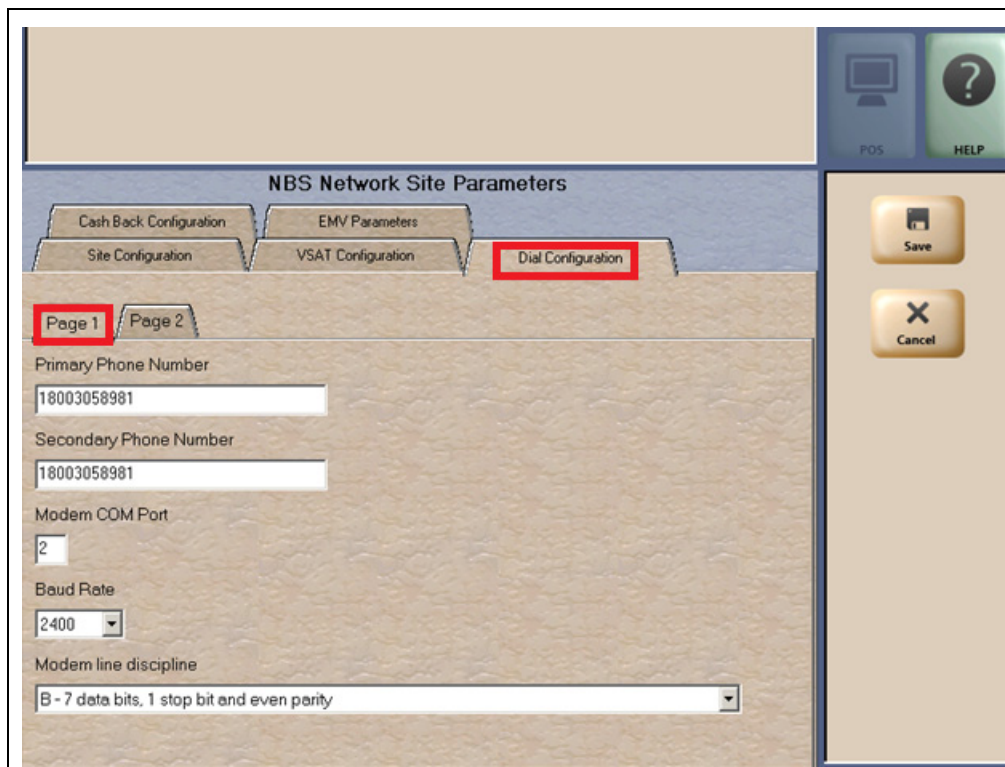

The following table lists the fields on the Dial Configuration - Page 1 tab:

Field	Description
Primary Phone Number	The phone number of the primary NBS processor used for this store.
Secondary Phone Number	The phone number of the secondary NBS processor used for this store.
Modem COM Port	The Serial Port used to connect to the modem. Default port is COM 7.
Baud Rate	The baud rate used to communicate with the modem. Default value is 2400. Set this field to 9600. Contact NBS Help Desk to confirm if the network is using 9600 baud rate, as well.
Modem line discipline	Options are: <ul style="list-style-type: none"> A = 8 data bits, 1 stop bit, no parity B = 7 data bits, 1 stop bit, even parity

CAUTION

Digital Subscriber Line (DSL) Modem connects directly to the Passport router. Connection provided by Datawire and Abierto, is not supported. These devices must be connected to a Serial Port on the Passport EDH and configured using the Dial Configuration tab. Failure to follow this instruction may result in loss of client communications or other adverse connectivity issues. For information on the appropriate cabling and data communication settings, contact the manufacturer of your DSL device. Do not connect the Datawire/Abierto box to the Internet port on the Passport router.

- 12 After completing all fields on the **Page 1** tab, select the **Page 2** tab.

Figure 8: Dial Configuration - Page 2 Tab

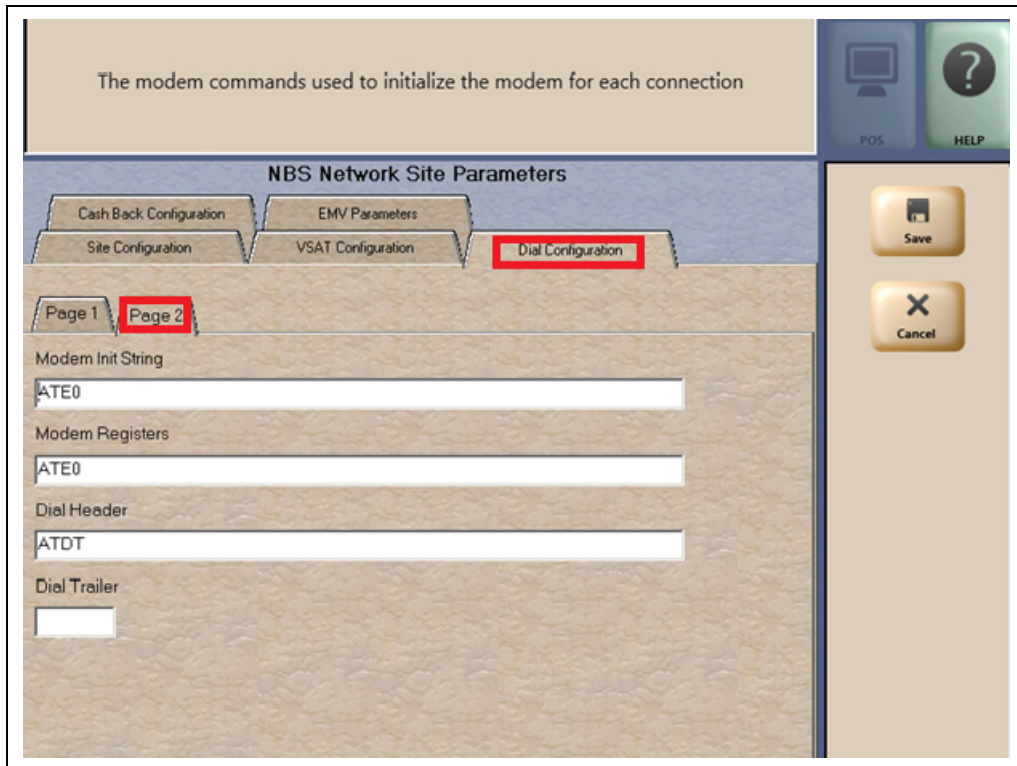

The following table lists the fields on the Dial Configuration - Page 2 tab:

Field	Description
Modem Init String	The modem initialization string that is sent to the modem each time a link is established. <i>Note: The modem string shown for initialization in Figure 8 is for the MultiTech® 56K V.90 modem device supplied with the Passport system. Gilbarco does not support strings for any other modem.</i>
Modem Registers	The register string used to specify other modem commands after the initialization string. <i>Note: The modem string shown for initialization in Figure 8 is for the MultiTech 56K V.90 modem device supplied with the Passport system. Gilbarco does not support strings for any other modem.</i>
Dial Header	Information that must be dialed before the phone number, which may include a code used to access an outside line.
Dial Trailer	Any information that must be dialed after the phone number.

- 13 Select the **Cash Back Configuration** tab.

Figure 9: Cash Back Configuration Tab

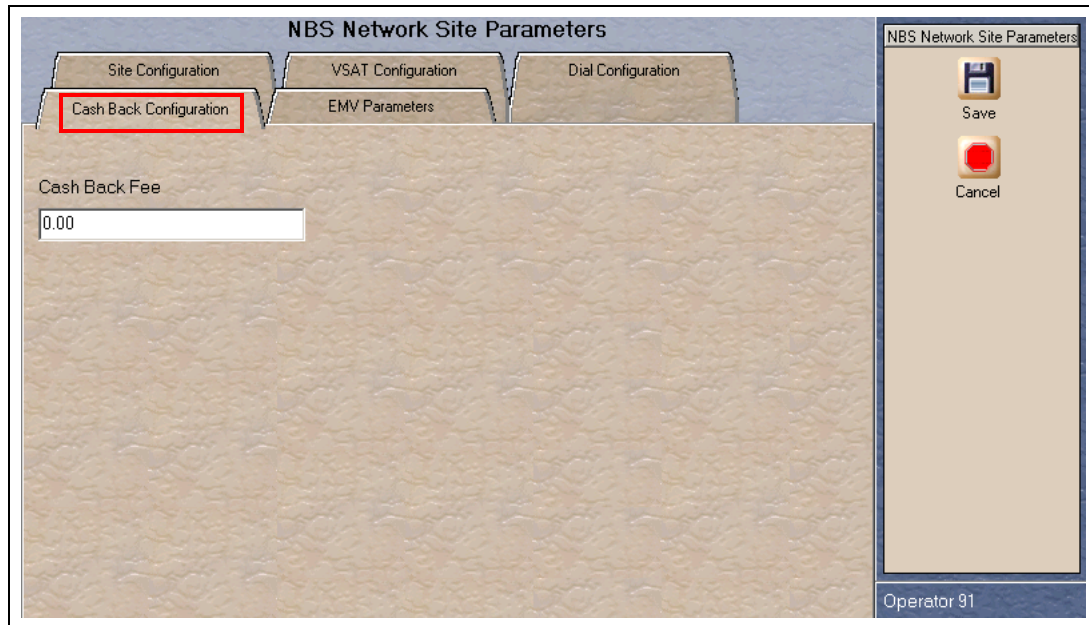

The following table lists the fields on the Cash Back Configuration tab:

Field	Description
Cash Back Fee	Fee that the store charges the customer for Cash Back in a transaction. Default is \$0.00.

- 14 After completing the Cash Back Configuration tab, select the **EMV Parameters** tab.

Figure 10: EMV Parameters Tab

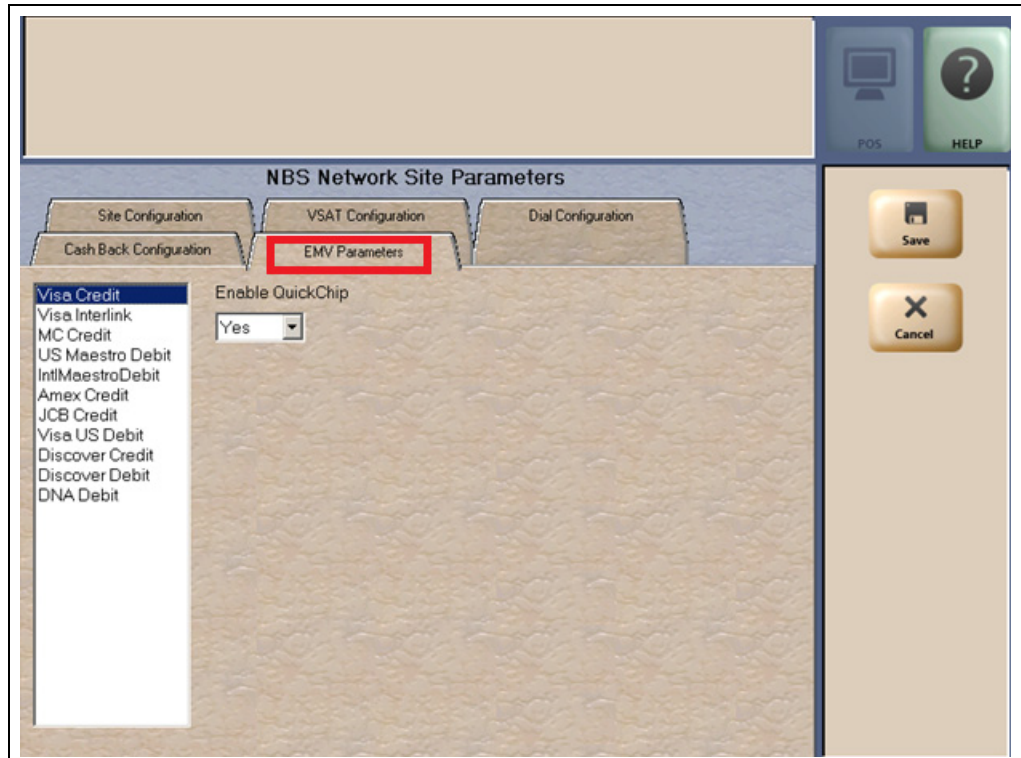

The following table lists the fields on the EMV Parameters tab:

Field	Description
Enable QuickChip	<p>If set to Yes, Passport obtains all necessary EMV data from the chip card before the transaction starts by notifying the chip card that the network is unavailable. As a result, the PIN pad prompts the customer to remove the chip card a few seconds before completing the transaction with the chip card issuer.</p> <p>If set to No, Passport performs EMV transactions without the shortcut of QuickChip processing. The PIN pad prompts the customer to remove the chip card after completing the transaction with the chip card issuer.</p> <p>Defaults to No.</p>

- 15 After completing the actions on the **EMV Parameters** tab, select **Save** to save all programming and exit the **Network Site Configuration**.

Accepting Magnetic Stripe Contactless Inside

Passport can be configured to accept tap for magnetic stripe contactless cards on VeriFone and Ingenico PIN pads. To allow contactless magnetic stripe taps at the PIN pad, proceed as follows:

- 1 Go to **MWS > Set Up > Register > Register Set Up**.
- 2 Select the register where the PIN pad is located.
- 3 In the **Device Configuration** section, select the **Contactless** check box.
- 4 Select **Save** to save the configuration and exit.

Figure 11: Register Set Up - Device Configuration

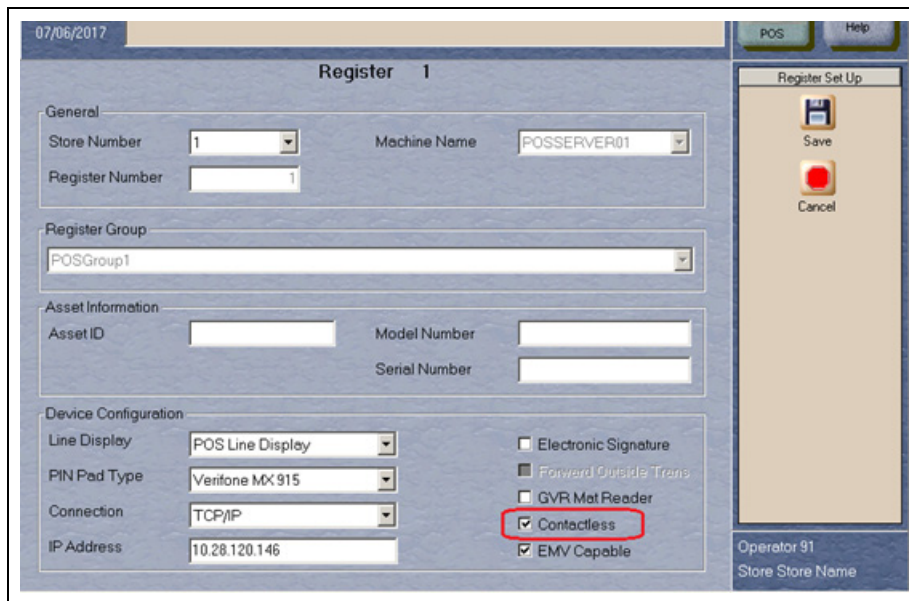

IMPORTANT INFORMATION

The NBS network does not yet support Contactless EMV cards. The Contactless field only affects mag stripe contactless tap.

If the customer attempts to present a contactless EMV card, Passport declines the transaction with the error message, **“Contactless not allowed”** on the CWS yellow bar and a **“Declined”** message in the PIN Pad.

Figure 12: CWS Message when Tapping Contactless EMV Card

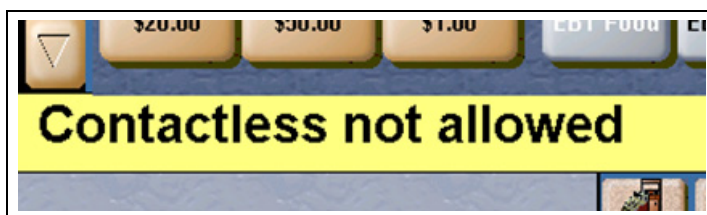

Requesting Card Configuration Download

To request a parameter download of all cards that can be authorized at a store, proceed as follows:

- 1 From the NBS Network menu screen, select **Card Configuration Download**.
- 2 The Passport system prompts, “**Do you want to continue with Parameter Download?**”

Figure 13: Card Configuration Download Screen

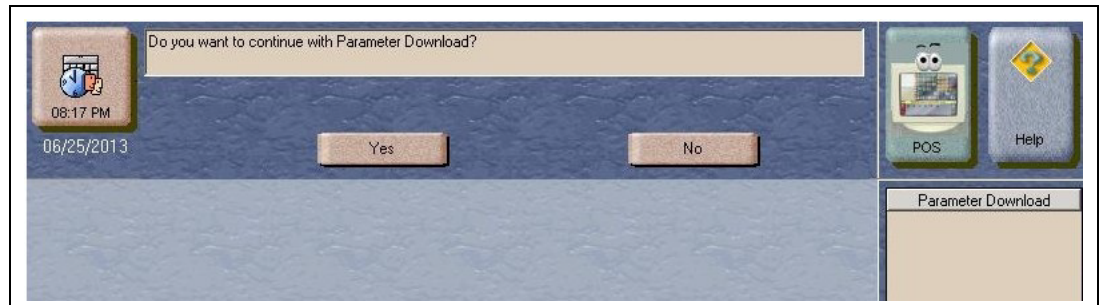

- If you select **No**, the system returns to the Network menu screen.
- If you select **Yes**, the system requests a Card Configuration Table from the NBS network.

IMPORTANT INFORMATION

A site cannot accept electronic forms of payment without successfully receiving a Card Configuration Table from the NBS network.

- 3 After the Passport system begins acquiring a Card Configuration Table, it provides information on the success of the download in the MWS message bar.

Figure 14: Requesting Card Configuration Table

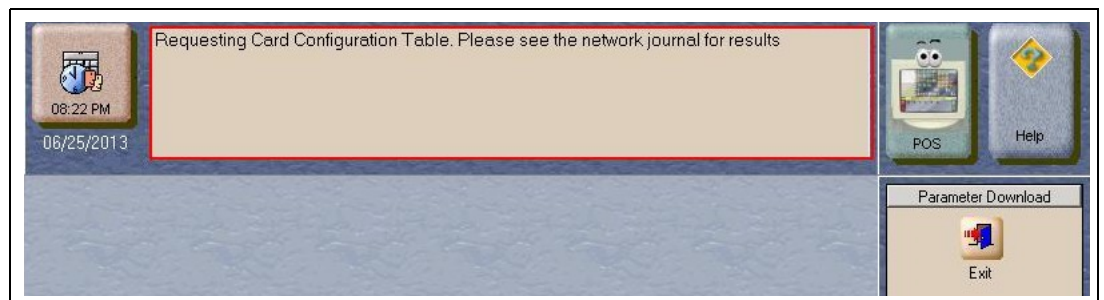

- 4 The Passport system connects to the NBS network and requests the download in the background.

If a Card Configuration Table download request fails, the message bar on the CWS displays an error message indicating the cause of failure. During a download request, the CWS Network Status icon displays a green NW LOW indicator. After a successful download, the NW LOW indicator disappears. In case of failure, the CWS displays NW MED. Network status displays for one minute after a download. Clicking the NW MED indicator causes the Network Status screen to open with the cause for the failure. If the download request fails, the Parameter Download software service stops and the Passport system continues to use any pre-existing Card Configuration tables.

After the Passport system successfully obtains a parameter download from the NBS network, the Passport system validates the file. If validation fails, the Passport system continues to use any pre-existing Card Configuration tables. In this case, the CWS Network Status indicator displays NW MED and the Network Status screen displays an error message indicating the cause for failure.

When the Card Configuration Download is complete, the Passport system displays a series of messages on the CWS:

- Card Configuration Download Requested
- Card Configuration Request Successful
- New Card Configuration Activated

Requesting EMV PDL Download

To request a parameter download of all EMV parameters that can be authorized at this store, proceed as follows:

- 1 From the NBS Network Menu screen, select **EMV PDL Download**.
- 2 The Passport system prompts, “**Do you want to continue with Parameter Download?**”

Figure 15: EMV Parameter Download Screen

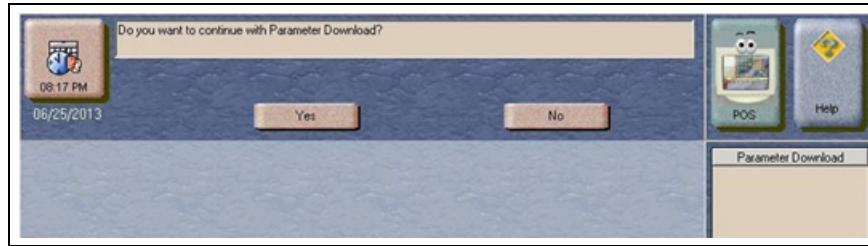

- If you select **No**, the system returns to the Network menu screen.
 - If you select **Yes**, the system requests an EMV Parameter Table from the NBS network.
- 3 The Passport system connects to the NBS network and requests the download in the background. After the Passport system has started to acquire an EMV Parameter Table, the Passport system provides information on successful download in the MWS message bar. The message “Requesting EMV configuration. Please see network journal for results” is displayed during the process. Two files are downloaded through this process (EMV Configuration and Public Keys). Passport will retry 5 times in every 5 minutes if any communication issue is encountered.
 - If the download request fails, the Passport system continues to use any pre-existing EMV Parameter Table. Network Journal provides additional information.

Passport Loyalty Configuration for Irving Rewards Loyalty Programs

IMPORTANT INFORMATION
Ensure the Enhanced Loyalty Interface or Multiple Loyalty Interface feature is activated before proceeding with Loyalty configuration. These instructions pertain only to the Irving Rewards program Irving supports. The settings shown will be the same from store to store, except for the items that are site specific, like Site Identifier.

Irving supports the Irving Rewards loyalty program with Excentus on the NBS Network.
To configure loyalty for an Irving store, proceed as follows:

- 1 Go to **MWS > Set Up > Store > Loyalty Interface**. The Loyalty Configuration screen opens.
- 2 If no Loyalty Provider Name displays on the **Loyalty Configuration** screen, no loyalty program has been configured yet. Select **Add**.

Figure 16: Loyalty Configuration Screen

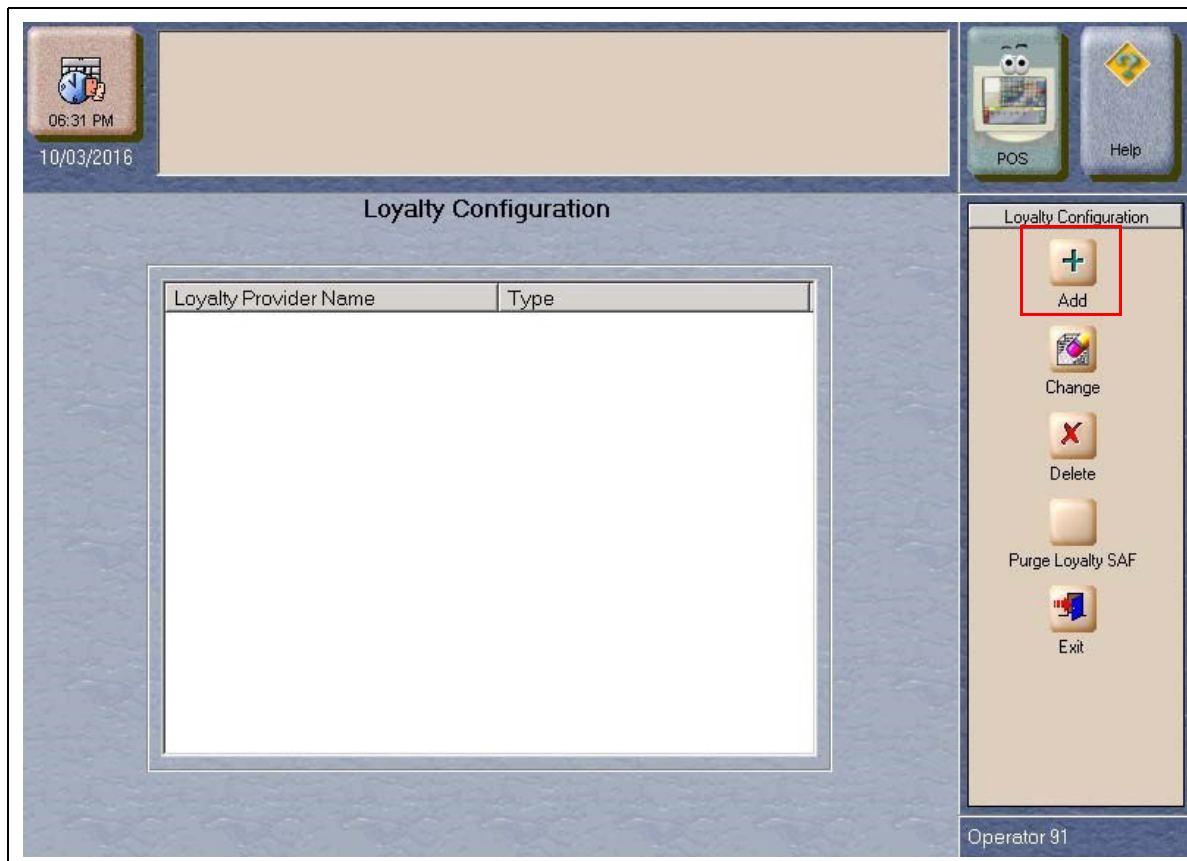

- 3 Enter the appropriate name (IRVING REWARDS) in the Loyalty Provider Name field and select **Generic** from the Loyalty Provider Type drop-down menu. Select Save to save the new loyalty program.

Figure 17: Add Loyalty Provider Screen

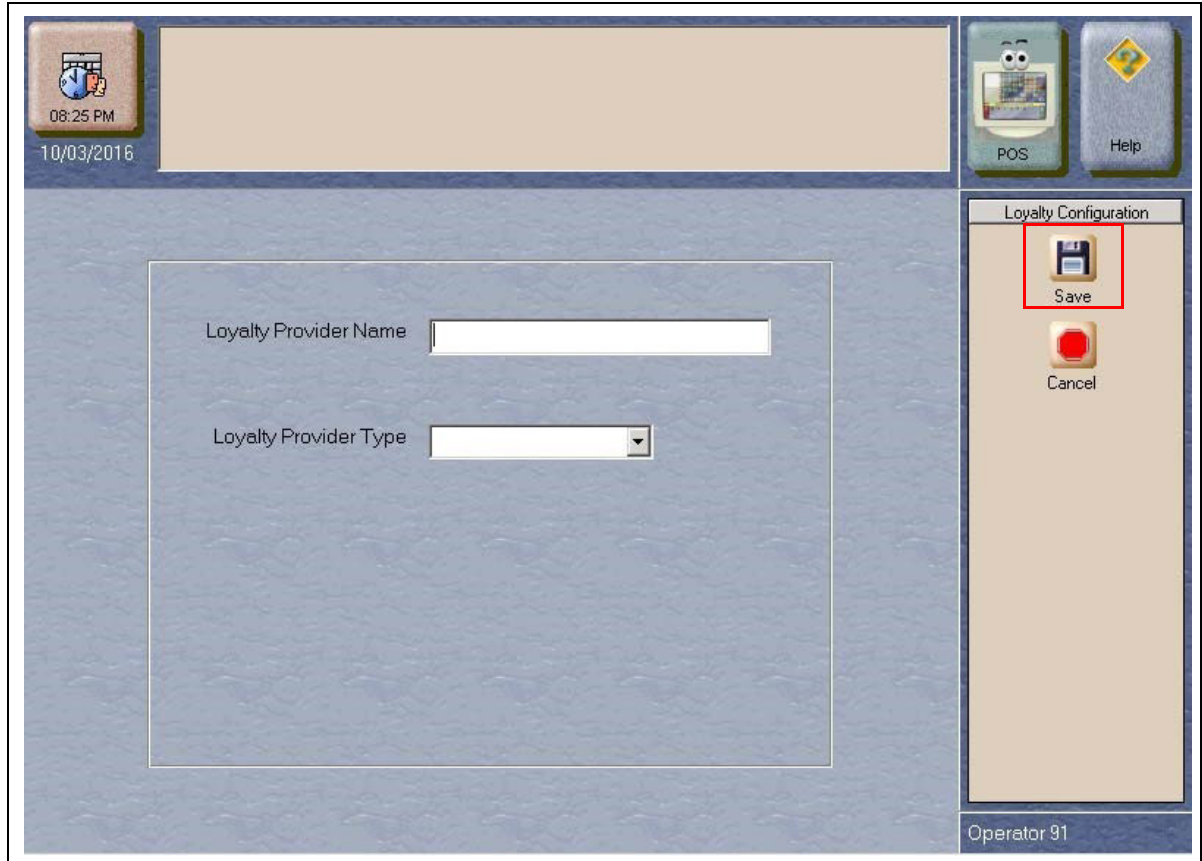

- The **Loyalty Configuration** tabs display with the **General - Page 1** tab selected. The **Loyalty Provider Name** and **Loyalty Provider Type** fields contain the values you saved in the previous step. Select the **Enabled** field drop-down menu and select **Yes** to access the remaining fields.

Note: Call the Excentus Help Desk at 1-877-445-9713 to reprogram the Irving Rewards Systech box for the IP address listed in the Host IP Address field (see [Figure 18](#)).

Figure 18: Loyalty Configuration - General - Page 1 Tab

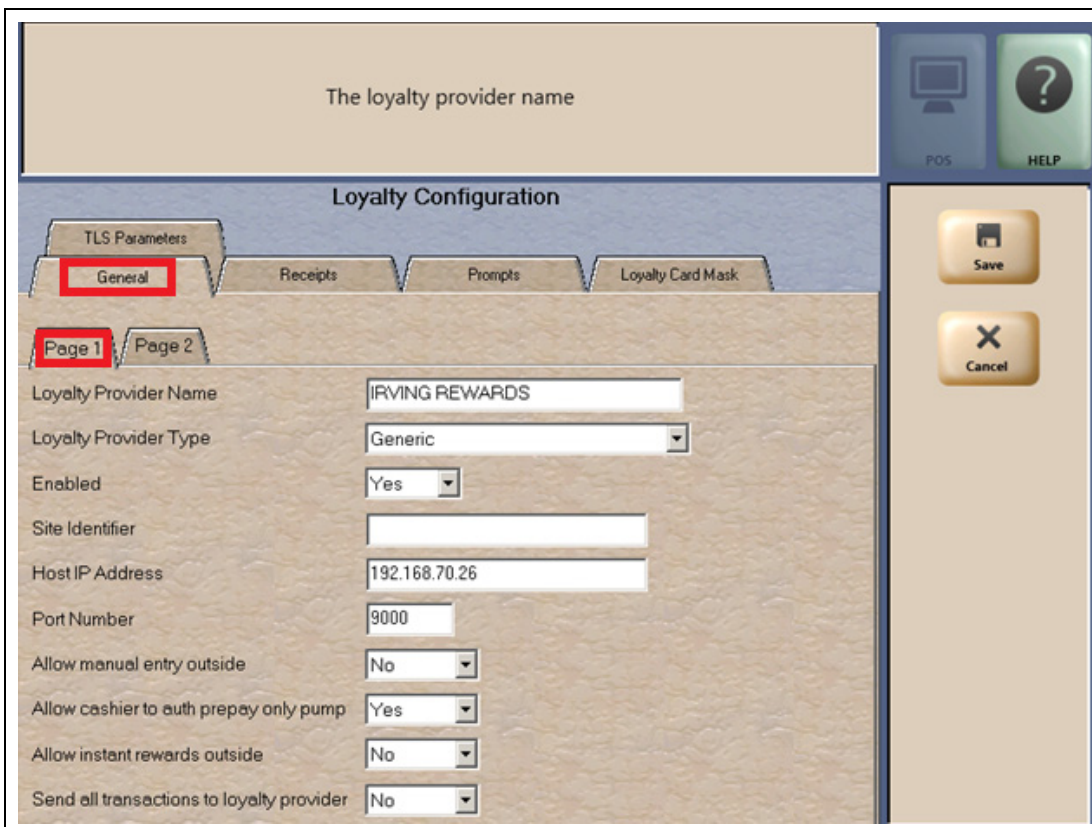

The following table contains the remaining fields on the Page 1 tab and the values to enter/select:

Field	Selection
Site Identifier	This field is the unique identifier the loyalty provider uses to identify this store. Passport adds leading zeroes to the number configured there to ensure the field contains 8 digits.
Host IP Address	Enter the value as 192.168.70.26
Port Number	Enter the value as 9000
Allow manual entry outside	Select No
Allow cashier to auth prepay only pump	Select Yes
Allow instant rewards outside	Select No
Send all transactions to loyalty provider	Select No

- 5 After entering all fields on the **General - Page 1** tab, select the **General - Page 2** tab.

Figure 19: General - Page 2 Tab

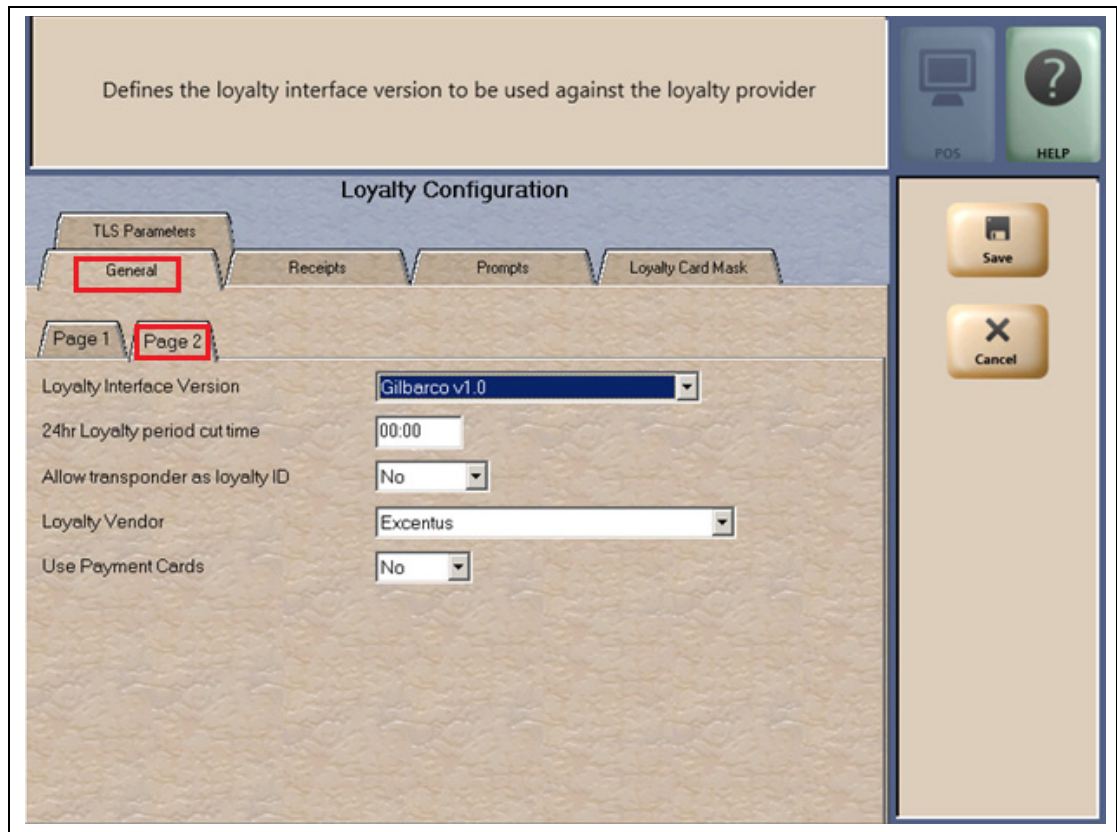

The default values on the **Page 2** tab are correct. Do not change any of the fields on this tab.

6 Select the **Receipts** tab.

Figure 20: Receipts Tab

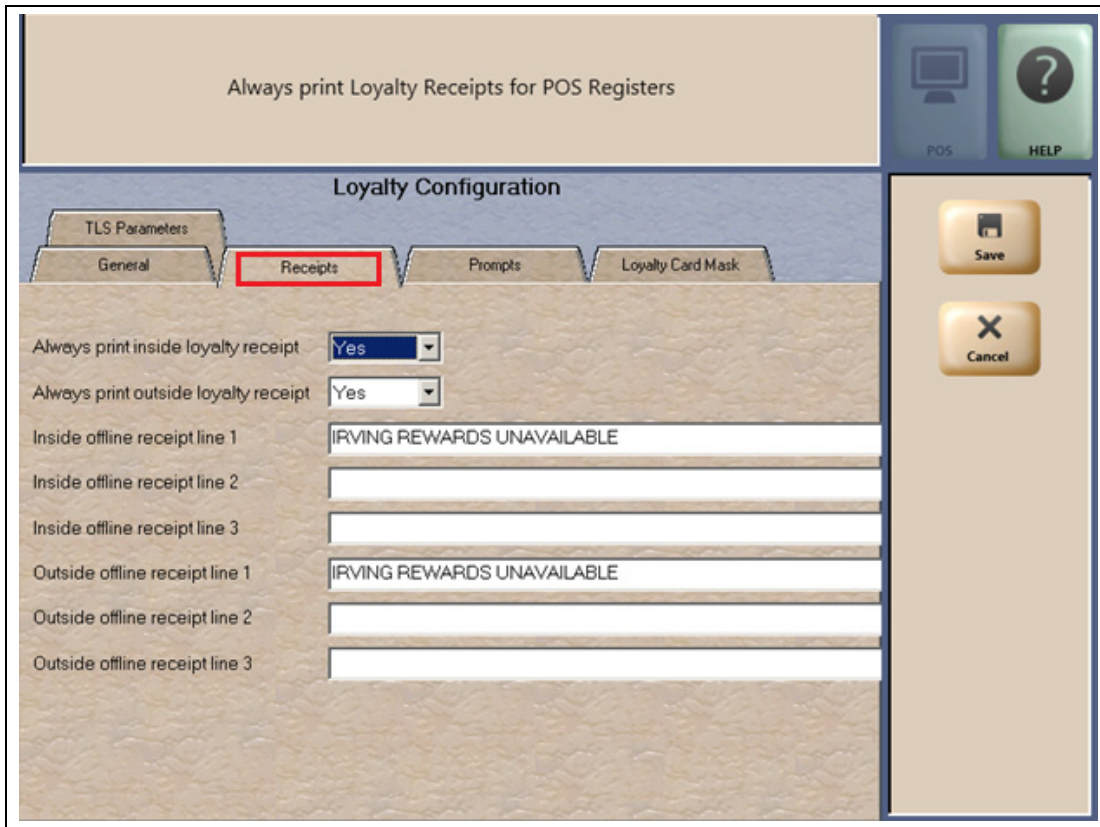

- Select **Yes** from the drop-down menu for both the Always print inside loyalty receipt and Always print outside loyalty receipt fields.
- Set “Inside offline receipt line 1” to “IRVING REWARDS UNAVAILABLE”.
- Set “Outside offline receipt line 1” to “IRVING REWARDS UNAVAILABLE”.
- Leave the rest of the fields blank.

7 Select the **Prompts** tab.

Figure 21: Prompts Tab

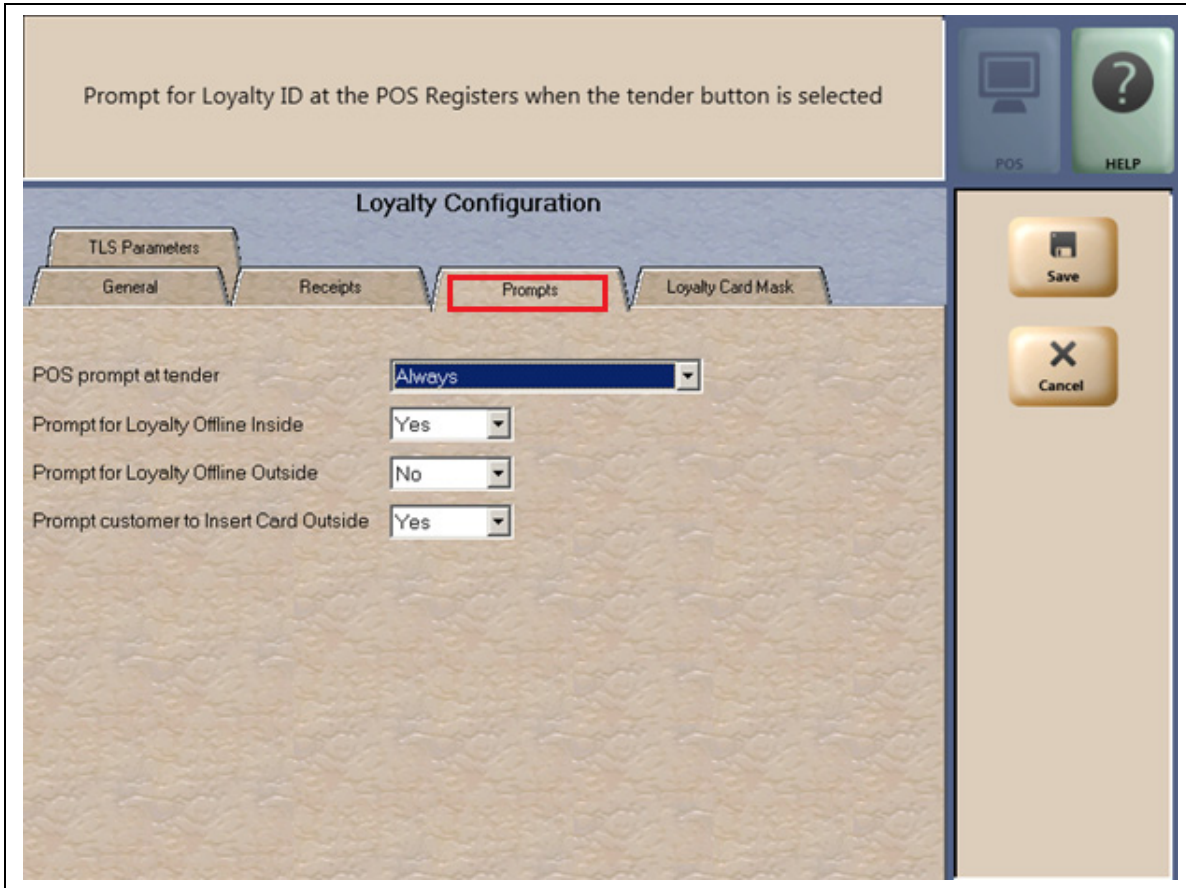

The following table lists the fields on the **Prompts** tab and the values to select:

Field	Selection
POS prompt at tender	Always
Prompt for Loyalty Offline Inside	Yes
Prompt for Loyalty Offline Outside	No
Prompt customer to Insert Card Outside	Yes

- 8 After completing the selections on the Prompts tab, select the **Loyalty Card Mask** tab. For each loyalty card mask to configure, select **Add** and then key in the following loyalty card mask:
- 636225

Figure 22: Loyalty Card Mask Entry

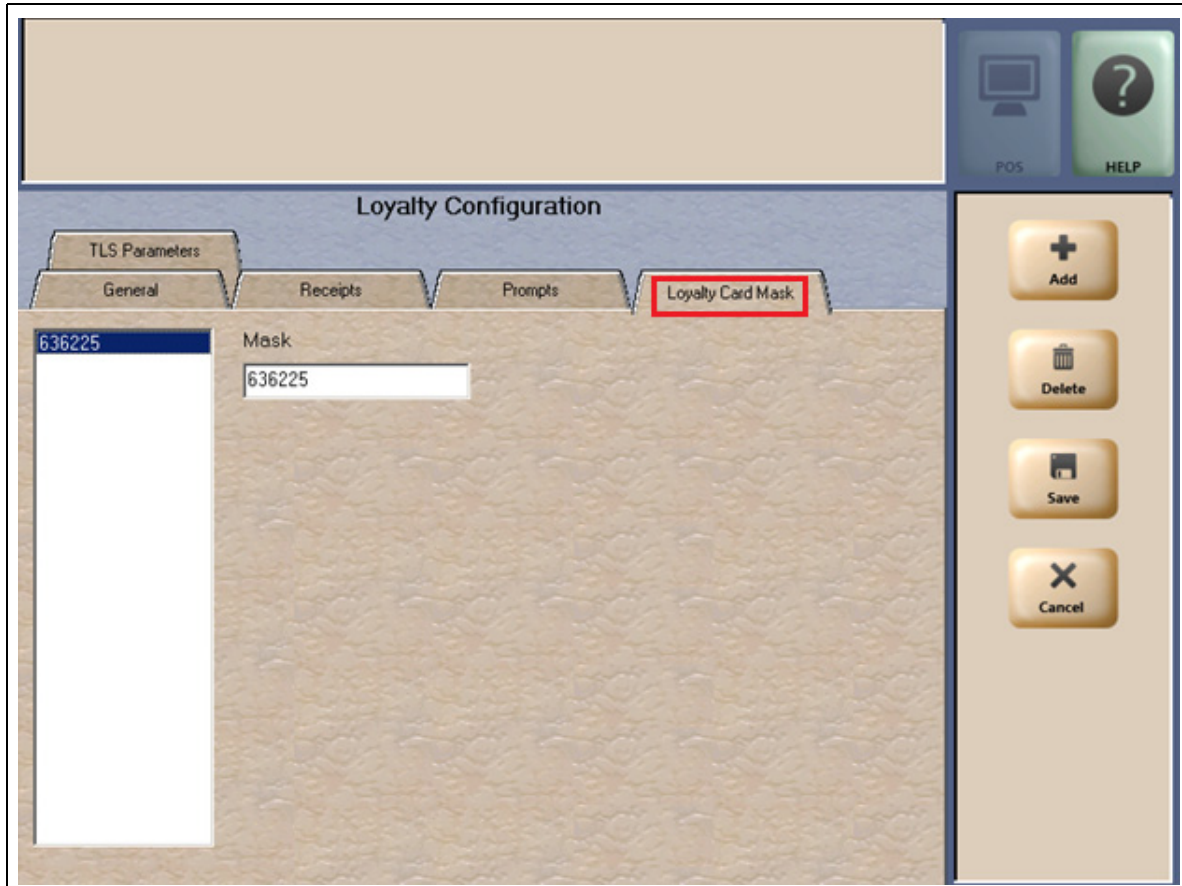

- 9 Select the **TLS Parameters** tab.

Figure 23: TLS Parameters Tab

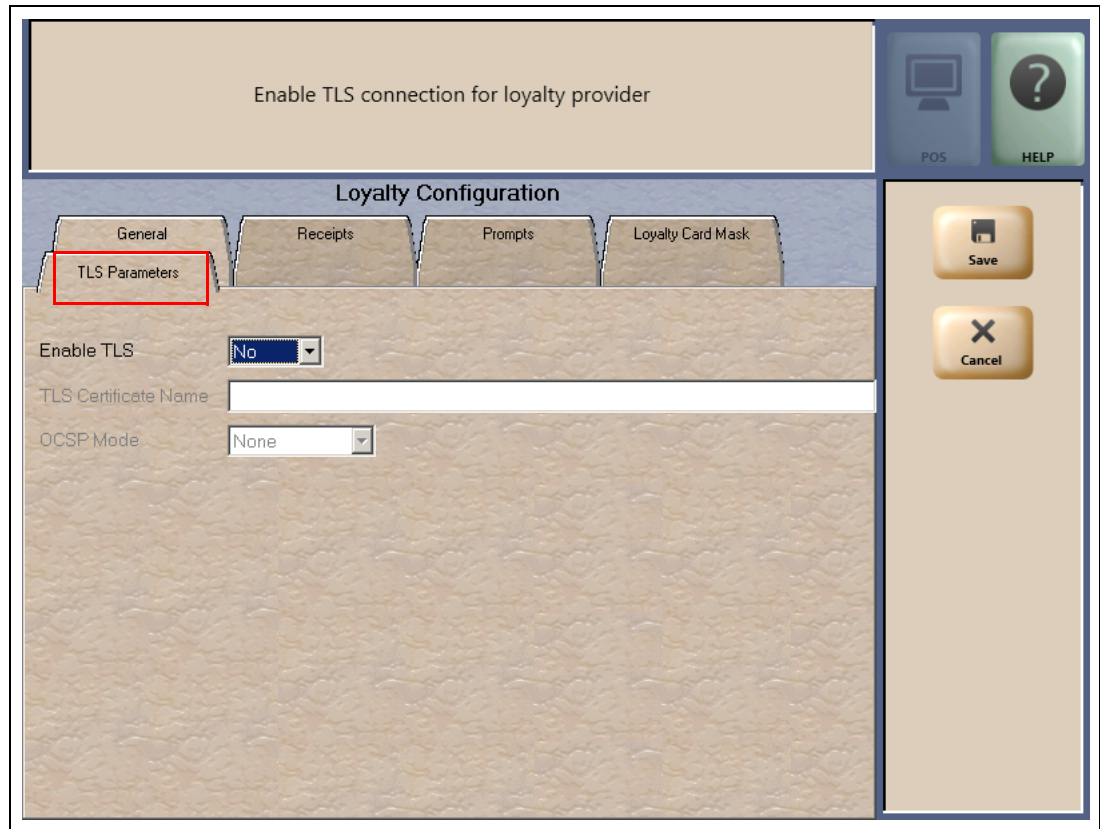

The following table lists the fields on the TLS Parameters tab and the values to select:

Field	Selection
Enable TLS	No
TLS Certificate Name	Leave field blank
OCSP Mode	Set to None

- 10 Set Enable TLS to **No**.
- 11 Select **Save** to save all the loyalty programming.

Irving Oil Discount Group for Irving Debit Pay Cards

To provide customers using Irving Debit Pay card with a fuel discount, a new discount group should be created in Fuel Discount Maintenance.

- 1 Go to **MWS > Fuel > Fuel Discount Maintenance**. The Fuel Discount Maintenance Configuration screen opens.

Figure 24: Fuel Discount Maintenance Discount Group

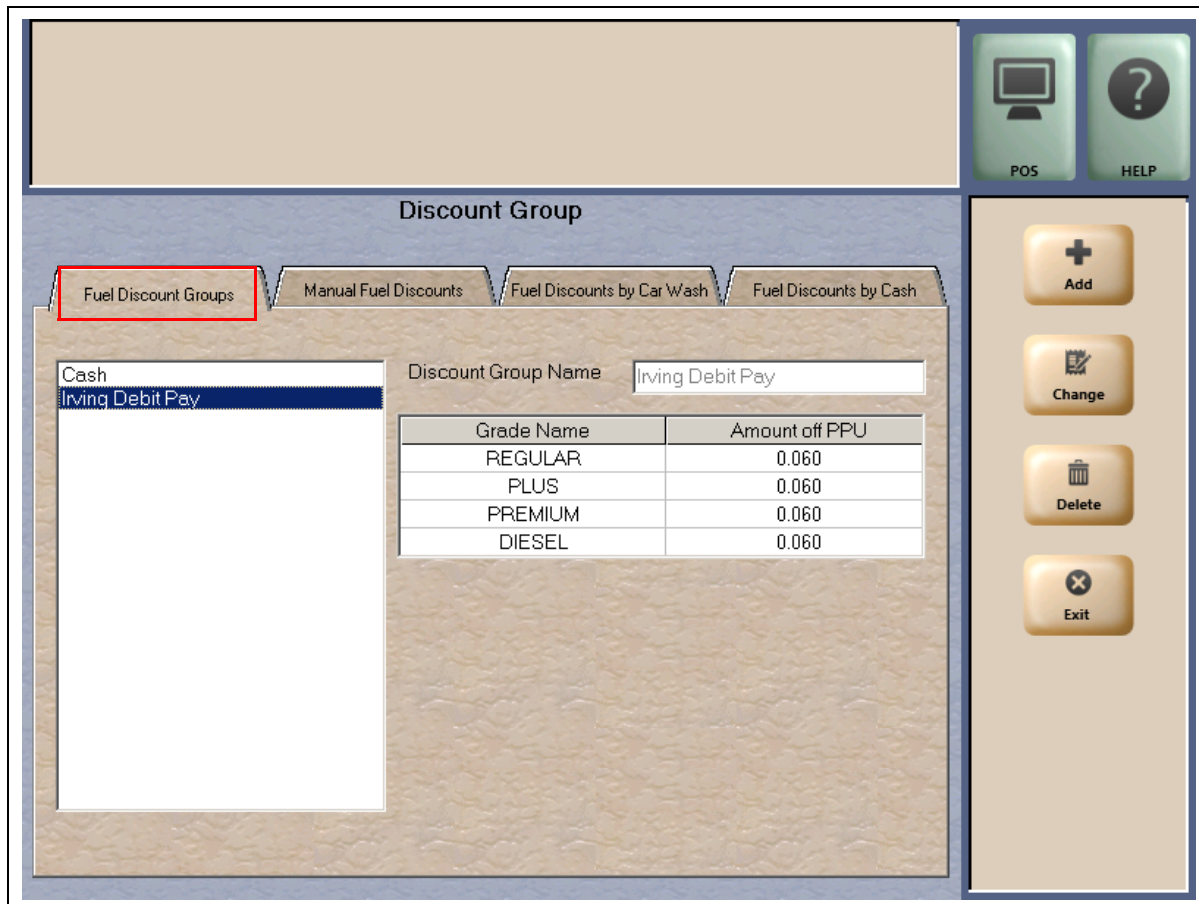

- 2 If no Irving Debit Pay group displays on the Fuel Discount Group Configuration screen, no fuel discount group has been configured yet. Select **Add**.
- 3 Enter **Irving Debit Pay** for the Discount Group Name.
- 4 Enter the Amount off PPU for each available grade.
- 5 Select the **Save** button to save the Fuel Discount Group Programming.

Passport Auxiliary Network Configuration for Irving Debit Pay

For Passport to accept and process Irving Debit Pay cards, the Auxiliary network is required to be configured.

IMPORTANT INFORMATION

Ensure that the Auxiliary Network feature is activated before proceeding with Auxiliary Network configuration.

These instructions pertain only to the Irving Debit Pay. Do not use these instructions if the merchant is not participating in this program.

The settings shown will be the same from store to store, except for the items that are site specific, like Site Identifier.

To configure Irving Debit Pay for an Irving store, proceed as follows:

- 1 Go to **MWS > Set Up > Network Menu > Auxiliary Network Menu > Auxiliary Network Site Configuration**. The Auxiliary Network Configuration screen opens.

Figure 25: Auxiliary Network Global Network Parameters

Serial port number where the ACU is connected

POS HELP

Auxiliary Network Global Network Parameters

Com Port	<input type="text" value="5"/>
Baud Rate	<input type="text" value="9600"/>
Data bits	<input type="text" value="7"/>
Stop Bit	<input type="text" value="1"/>
Parity Bit	<input type="text" value="Even Parity"/>
ACK Timer	<input type="text" value="5000"/>
Response Timer	<input type="text" value="60000"/>
NAK Quantity	<input type="text" value="2"/>
Comm Test Timer Polling	<input type="text" value="10000"/>
Site ID	<input type="text" value="0"/>
Print store copy of the receipt inside	<input type="text" value="Yes"/>
Print customer copy of the receipt inside	<input type="text" value="Yes"/>

Save Cancel

The following table contains the fields and their selection for the Auxiliary Network Global Network Parameters:

Field	Selection
Com Port	Enter the value 5
Baud Rate	Select the value 9600
Data Bits	Enter the value 7
Stop Bit	Enter the value 1
Parity Bit	Select the value Even Parity
ACK Timer	Enter the value 5000
Response Timer	Enter the value 60000
NAK Quantity	Enter the value 2
Comm. Test Timer Polling	Enter the value 10000
Site ID	Enter the site ID
Print store copy of receipt inside	Select Yes
Print customer copy of receipt inside	Select Yes

- 2 Select **Save** to save all the Auxiliary Network programming.
- 3 Go to **MWS > Set Up > Network Menu > Auxiliary Network Menu > Auxiliary Network Card Configuration**. The Auxiliary Network Card Configuration screen opens.

Figure 26: Auxiliary Network Card Config

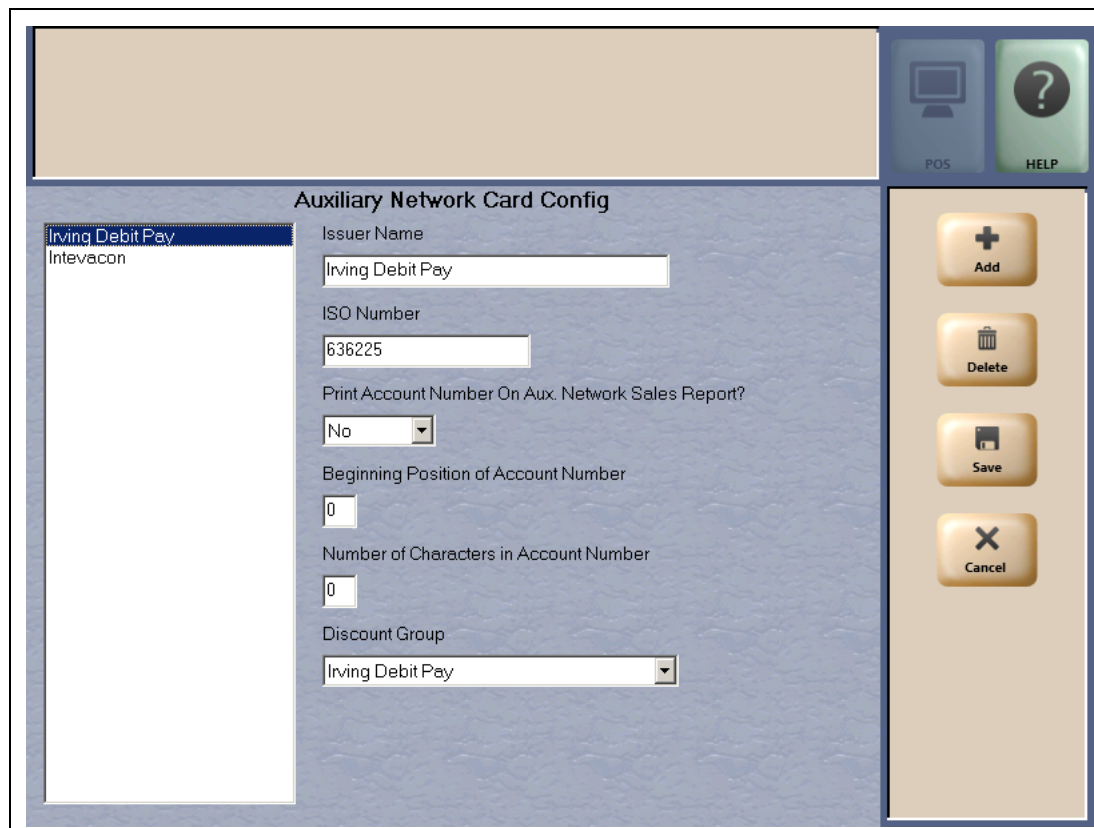

The following table contains the fields and their selection for the Auxiliary Network Card Configuration parameters:

Field	Selection
Issuer Name	Enter Irving Debit Pay
ISO Number	Enter the value 636225
Print Account Number on Aux. Network Sales Report	Select the value No
Beginning Position Account Number	Enter the value 0
Number of Characters in Account Number	Enter the value 0
Discount Group	Select Irving Debit Pay

- 4 Select **Save** to save all the Auxiliary Network Card Configuration programming.

EBT Food and EBT Cash Tenders

The NBS Network supports processing EBT Food and EBT Cash. Call the NBS Help Desk at 1-800-827-4634 and provide the site's FNS number and a copy of the certificate for EBT to be enabled on the PDL.

EBT Food and EBT Cash tenders have been added to Tender Maintenance

The tender options for EBT Cash and EBT Food have been preconfigured, with the exception of the "NACS Tender code" and "Allow safe drops". These may be configured as needed by the site. The tender group assigned to EBT Cash and EBT Food should not be changed. If the site had previously defined EBT Cash tender in an earlier version with the description EBT Cash, the new tender will be named EBT Cash*. You can choose to deactivate the old EBT Cash tender and use the new EBT Tender.

Inform Back Office partners of EBT Cash and EBT Food Tender Configuration

Ensure that your tender mapping with the back office is correct for reporting and tender restrictions. Go to **Reports > Back Office Reports** and execute the Tender Code Report to view the Passport tender code and the NACS tender code.

EBT Card Transactions

The EBT Food tender applies food stamp restrictions to the items in the transaction as well as forgives tax for the items that qualify for food stamps.

Passport allows EBT transactions inside only. EBT cards are not accepted outside at the dispenser. EBT Cash is accepted for all inside transactions including prepaid fuel transactions. EBT Cash and EBT Food transactions do not require customer PIN entry.

Passport also allows cash back for EBT Cash and applies a debit cash back transaction fee (similar to debit transactions), based on programming in Network Site Configuration. If the customer requests cash back with EBT Cash tender, Passport does not allow split tender. The EBT Cash card must cover the entire amount of the transaction, including cash back. If Passport receives partial approval for EBT Cash in which the customer requested cash back, the CWS prompts the cashier to perform a manual refund of the partially approved EBT Cash tender. The manual refund is necessary because of the PIN entry requirement on the sale transaction.

For split tender with EBT Food, the customer must present the EBT Food card as first payment.

Balance Inquiry

The cashier can use the Balance Inquiry button that appears on the **Network Status** screen to obtain the remaining balance on cash cards as well as EBT cards. After the cashier swipes the card, if Passport cannot identify the card as a cash card, Passport prompts the cashier if the card is an EBT Cash card. If the cashier responds with Yes, Passport makes an EBT Cash card balance request; otherwise, Passport makes an EBT Food card balance inquiry.

Network Reports

In the default installation, no network reports are configured to print at Shift or Store Close. Review the reports and select those appropriate for your store's operation. For information about the overall report setup, and to set the reports that must be printed during Shift or Store Close, refer to *MDE-5025 Passport V9+ System Reference Manual*.

The following table lists all the NBS network reports:

Report Name	Shift Close	Store Close	Current	Secure
NBS Card Configuration Report	-	X	X	-
NBS Card Conflict Report	-	-	X	-
NBS EMV Chip CAPK Report	-	-	X	-
NBS EMV Chip Configuration Report	-	-	X	-
NBS EMV/Chip Fallback report	-	-	X	-
NBS Site Configuration Report	-	-	X	-
NBS Prepaid/Loyalty Card Activity Report	-	X	X	-
NBS POS Transaction Statistics Report	-	X	X	-
NBS Sales Report by Day	-	X	X	-
NBS Sales Report by Shift	X	X	X	-
NBS Settlement Report	-	X	X	-
NBS Unpaid Transactions Report	-	X	X	-
Site Level Card Based Fuel Discounts	-	-	X	-

IMPORTANT INFORMATION

Secure Reports contain sensitive customer data such as card account number and expiration date. These reports can be printed on demand only and are password protected. For more information on Secure Reports, refer to *MDE-5514 Passport EDH (NBS) V10.32 Implementation Guide for PA-DSS V3.2*

For the NBS network, a Store Close must be performed periodically to close out the network batch. A Shift Close does not perform this function. If a network batch is not closed periodically, payment from the network may become slow and the Passport system may stop accepting network sales.

- 1 From the Reports menu, select **Network**. The Network Reports menu screen opens.
 - a The Network Reports menu contains Auxiliary Network and NBS network reports. The following section describes each of the NBS network reports available.

NBS Card Configuration Report

The NBS Card Configuration Report provides information contained within the parameter table download. Information printed on this report applies only to the cards that are accepted for payment by the NBS network.

Figure 27: NBS Card Configuration Report

```

Version: 1

Card: American Express
NBS Card Code: BC
PAN Range High: 349999
PAN Range Low: 340000
PAN Length: 15
Mask Account: XXXXXXXXXXXX####
PAN Range High: 379999
PAN Range Low: 370000
PAN Length: 15
Mask Account: XXXXXXXXXXXX####
Track to send to the Host: 2 | 1 |
Expiration date format: YYMM
Expiration date Check: Yes

Card: Diners
NBS Card Code: BC
PAN Range High: 309999
PAN Range Low: 300000
PAN Length: 14
Mask Account: XXXXXXXXXXXX####
PAN Range High: 369999
    
```

NBS Card Conflict Report

The Card Conflict Report provides the number of conflict instances within the current period. Conflicts can occur when a card configured for one network is processed by another network.

Figure 28: NBS Card Conflict Report

Card Conflicts		
PERIOD FROM 6/21/2013 6:04:56 AM TO 6/25/2013 8:59:50 AM		
Issuer Name - Processing Network	Issuer Name - Configured Network	Conflict Instances (current period)
MasterCard	Cenex	
Cenex	Mannatec	
MasterCard	Cenex	
Cenex	Mannatec	

NBS EMV/Chip CAPK Report

This report is used to check and validate the CAPK that are loaded into Passport and/or EMV-capable PIN pad for all card brands/schemes that are supported by Passport and/or EMV-capable PIN pad.

Figure 29: NBS EMV/Chip CAPK Report

EMV/CHIP CAPK Report	
Created: Nov 24, 2016 13:15	
Old Station Address City - ST - 3215444 1111111111111111	
<hr/>	
Card Brand Name:	VISA
RID:	A000000003
Index:	92
Modulus:	996AF56F569187D09293C14810450ED8EE3357397B18A2458EFAA92DA3B6DF6514EC060195318FD43BE9B8F0CC66 9E3F844057CBDDF8BDA191BB64473BC8DC9A730DB8F6B4EDE3924186FFD9B8C7735789C23A36BA0B8AF65372E B57EA5D89E7D14E9C7B6B557460F10885DA16AC923F15AF3758F0F03EBD3C5C2C949CBA306DB44E6A2C076C5F 67E281D7EF56785DC4D75945E491F01918800A9E2DC66F60080566CE0DAF8D17EAD46AD8E30A247C9F
Exponent:	03
Expiration Date:	2017-12-31
<hr/>	
Card Brand Name:	VISA
RID:	A000000003
Index:	94
Modulus:	ACD2B12302EE644F3F835ABD1FC7A6F62CCE48FFEC622AA8EF062BEF6FB8BA8BC68BBF6AB5870EED579BC397 3E121303D34841A796D6DCBC41DBF9E52C4609795C0CCF7EE86FA1D5CB041071ED2C51D2202F63F1156C58A92D 38BC60BDF424E1776E2BC9648078A03B36FB554375FC53D57C73F5160EA59F3AFC5398EC7B67758D65C9BFF7828 B6B82D4BE124A416AB7301914311EA462C19F771F31B3B57336000DFF732D3B83DE07052D730354D297BEC72871D CCF0E193F171ABA27EE464C6A97690943D59BDABB2A27EB71CEEBAFA1176046478FD62FEC452D5CA39329653 0AA3F41927ADFE434A2DF2AE3054F8840657A26E0FC617
Exponent:	03
Expiration Date:	2017-12-31
<hr/>	
Card Brand Name:	VISA

NBS EMV/Chip Configuration Report

This report must identify all the EMV parameters required to be configured in Passport and/or EMV-enabled PIN pad for all card brands/schemes that are supported by Passport and/or EMV-enabled PIN pads.

There are two sub-sections:

- Site level configuration parameters (at the beginning of the report)
- AID with its parameters (displaying contact and contactless parameters)

Figure 30: NBS EMV/Chip Configuration Report

<u>EMV/CHIP Configuration Report</u>		Created: Nov 24,2016 13:16
Old Station Address City - ST - 3215444 111111111111111111		
TID: 1	Application Ver / EMV Kernel Ver: 1904 0467	EMV Enabled: True
TID: 2	Application Ver / EMV Kernel Ver:	EMV Enabled: True
Site Configuration:		
Terminal Type:	22	
Terminal Country Code:	840	
Transaction Currency Code:	840	
Transaction Currency Exp:	2	
Transaction Ref Currency Code:	840	
Transaction Ref Currency Exp:	2	
US Common Debit Preferred:	True	
Brand Not Present Fallback Enabled:	True	
Fallback Enabled:	True	
AID: A00000002501	Amex Credit	
Additional Terminal Capabilities:	60080B001	
Application Version:	0001	
BRS Max Target Percentage:	0	
BRS Target Percentage:	0	
BRS Threshold:	0	
Default DDOL:	9F3704	
Default TDOL:		
Fallback Enabled:	True	
AID Type:	Credit	
PAN Expiry Validation Enabled:	True	
Partial Selection Enabled:	True	
PIN Entry Bypass Enabled:	True	
Floor Limit:	0	
TAC Default:	000000000	
TAC Denial:	000000000	
TAC Online:	000000000	
Terminal Capabilities:	E0F8C8	
Contactless Settings		
Application Version:	0001	
Default TDOL:	9F020695055F2A029A039C019F3704	
PAN Expiry Validation Enabled:	True	
CVM Limit:	10	
Transaction Limit:	15	
Terminal Floor Limit:	12	
TAC Default:	DC50840000	
TAC Denial:	C400000000	
TAC Online:	000000000	
Terminal Transaction Qualifiers:	B6204000	
Terminal Risk Management TTQ:	B6004000	
Below Term Capabilities:	E028C8	
Above Term Capabilities:	E028C8	
MSR Contactless CVM Required Limit:	0	
QuickChip:	Disabled	
AID: A0000006200620	DNA Debit	
Additional Terminal Capabilities:	60080B001	
Application Version:	0000	

NBS EMV/Chip Fallback Report

This report provides detailed information on EMV chip fallback transaction processing considering both the attendant and PIN pad (chip reader) fallback statistics. This is useful in identifying the source of fallback transactions and helps remediate the cause, whether it be an attendant issue or a PIN pad issue.

The EMV/Chip Fallback Report is based on the current, non-settled transactions that reside in the batch only for inside transactions.

Figure 31: NBS EMV/Chip Fallback Report

EMV/CHIP Fallback Report						Created: Nov 24,2016 13:16
Old Station Address City - ST - 3215444 1111111111111111						
TOTAL EMV/CHIP CARD TRANSACTIONS: 1						
FALLBACK	TRANS	% OF CHIP TRANS	TOTAL	0	0.00%	

NBS Site Configuration Report

The NBS Site Configuration Report provides information that is configured and stored within the Passport system through the NBS Network Configuration menu to allow connection to the NBS network.

Note: It is recommended that the store print this report and keep it in a safe place in case of catastrophic system failure or other circumstances that would require reconfiguration.

Figure 32: NBS Site Configuration Report

Site Information:	
Terminal ID:	1111111111111111
Site Name:	Old Station
Street Address:	Address
City :	City
State :	ST
Zip Code:	3215444
Configuration Name:	CHSGP01
Cash Back Fee:	0
US Debit Preferred:	YES
Global Options:	
Host Connection Type:	VSAT
ACK Timeout (ms):	5000
Response Timeout (ms):	35000
Days To Keep:	30
TCP/IP Parameters:	
Primary IP Address:	10.5.48.6
Primary Port Number:	5003
Secondary IP Address:	10.5.48.6
Secondary Port Number:	5003
Use TLS:	NO
Dial Parameters:	
Primary Phone Number:	18002222222
Secondary Phone Number:	18003333333
Com Port:	0
Baud Rate:	2400
Modem Init String:	AT&F0V0E0&K0&Q6%CX4S37=5&Z0
Modem Registers:	ATS7=20S10=2S11=50S25=0&W0
Modem Line Discipline:	A - 8 data bits, 1stop bit and no parity
Dial Header:	
Dial Trailer:	

NBS Prepaid/Loyalty Card Activity Report

The NBS Prepaid/Loyalty Card Activity Report provides settlement information on prepaid gift card and loyalty card transactions that come from the NBS network.

Figure 33: NBS Prepaid/Loyalty Card Activity Report

NBS Prepaid/Loyalty Card Activity		
PERIOD FROM 12/26/2016 6:19:07 AM TO 1/3/2017 12:48:03 PM		
Action	Count	Total
Activations	11	220.00
Recharges	0	0.00
Enrollments	2	0.00

NBS POS Transaction Statistics Report

This report is used to identify the manner in which all transactions, including EMV/Chip transactions, are being processed by Passport.

Figure 34: NBS POS Transaction Statistics Report

POS Transaction Statistics Report		
		Created: Dec 05,2016 14:22
		PERIOD FROM 12/5/2016 8:25:20 AM
Old Station		
Address 123		
City - ST - 21456		
GP1078444050401		
TOTAL TRANSACTIONS: 32		
ENTRY MODE	TRANS	% OF TRANS
Manual	0	0
Swiped	5	15.63
MSD contactless	0	0
EMV contact	26	81.25
Swiped fallback	1	3.13
Manual fallback	0	0
EMV contactless	0	0
PINPAD DETAIL		
EMV card read failures:	7	
PIN entry errors:	0	

The report lists the types of cards and entry methods being used:

- Manual
- Swiped
- MSD contactless
- EMV contact
- Swiped fallback
- Manual fallback
- EMV contactless

Network Sales Report by Day (Shift)

The Passport system assigns a unique transaction number to each transaction it sends to the NBS network for processing. The Network Sales Reports include detailed information for each sale and refund transaction for that day or shift. Each transaction entry includes products, PPU, and total transaction amount. The entries in the report are sorted in ascending order by transaction number.

If a refund transaction is associated with a valid original sale invoice number, the Trans Refunded # field contains the original sale invoice number. If the refund transaction is not associated with a valid original sale invoice number, the Refund Transaction number field is blank, indicating the transaction was a general refund.

Note: This report does not include voided or declined sales.

To protect sensitive customer data, all but the last four digits of the card account number are masked on the report. If no NBS network transactions are run within a specific reporting shift or day, the report shows zeroes for all totals.

Note: The Network Sales Report By Shift uses the same format as the Network Sales Report By Day.

Figure 35: Network Sales by Day

Network Sales By Day				
PERIOD FROM 12/26/2016 6:19:07 AM TO 1/3/2017 12:48:03 PM				
Trans #	Date/Time	Card #	Trans Refunded #	Trans Total
10004	2016-12-26 12:36:37	XXXXXXXXXXXXXXXX0267		\$0.01
	<u>P.Code</u>	<u>Description</u>	<u>Quantity</u>	<u>PPU</u>
	400	Generic Item	1	\$0.010
				<u>Amount</u>
				\$0.01
10014	2016-12-30 07:27:04	XXXXXXXXXXXXXXXX3337		\$1.00
	<u>P.Code</u>	<u>Description</u>	<u>Quantity</u>	<u>PPU</u>
	400	Generic Item	1	\$1.000
				<u>Amount</u>
				\$1.00
10024	2016-12-31 12:43:24	XXXXXXXXXXXXXXXX0012		\$2.00
	<u>P.Code</u>	<u>Description</u>	<u>Quantity</u>	<u>PPU</u>
	400	Generic Item	1	\$2.000
				<u>Amount</u>
				\$2.00
10025	2016-12-31 12:45:10	XXXXXXXXXXXXXXXX0012		\$0.01
	<u>P.Code</u>	<u>Description</u>	<u>Quantity</u>	<u>PPU</u>
	400	Generic Item	1	\$0.010
				<u>Amount</u>
				\$0.01
10026	2016-12-31 12:46:32	XXXXXXXXXXXXXXXX0012		\$0.01
	<u>P.Code</u>	<u>Description</u>	<u>Quantity</u>	<u>PPU</u>
	400	Generic Item	1	\$0.010
				<u>Amount</u>
				\$0.01

Settlement Report

The Settlement Report provides a comparison of local and network totals for sales and refunds of each card type for a particular period. The bottom of the report indicates whether the local and network totals are “Balanced” or “Out of Balance”. The store manager can use this report to verify whether the Passport system and NBS network totals agree.

Figure 36: Settlement Report

Settlement					
PERIOD FROM 12/26/2016 6:19:07 AM TO 1/3/2017 12:48:05 PM					
		Site		Host	
	Number		Total	Number	Total
American Express Diners Discover	127		\$6,644.05	127	\$6,644.05
Card JCB UnionPay Visa MasterCard					
Sales	124		\$6,528.05	124	\$6,528.05
Refund	0		\$0.00	0	\$0.00
Card decline after host approval	2		\$89.00	2	\$89.00
Card pre-decline (report to host)	1		\$27.00	1	\$27.00
Debit	2		\$0.02	2	\$0.02
Sales	2		\$0.02	2	\$0.02
Refund	0		\$0.00	0	\$0.00
MasterCard Fleet	0		\$0.00	0	\$0.00
Sales	0		\$0.00	0	\$0.00
Refund	0		\$0.00	0	\$0.00
MasterCard (Corporate)	1		\$10.00	1	\$10.00
Sales	0		\$0.00	0	\$0.00
Refund	0		\$0.00	0	\$0.00
Card pre-decline (report to host)	1		\$10.00	1	\$10.00
Visa Fleet	0		\$0.00	0	\$0.00
Sales	0		\$0.00	0	\$0.00
Refund	0		\$0.00	0	\$0.00
Visa (Corporate)	6		\$858.00	6	\$858.00
Sales	0		\$0.00	0	\$0.00
Refund	0		\$0.00	0	\$0.00
Card pre-decline (report to host)	6		\$858.00	6	\$858.00
All EBT	0		\$0.00	0	\$0.00
Sales	0		\$0.00	0	\$0.00
Refund	0		\$0.00	0	\$0.00
All Debit	2		\$0.02	2	\$0.02
Sales	2		\$0.02	2	\$0.02
Refund	0		\$0.00	0	\$0.00
All Credit	134		\$7,512.05	134	\$7,512.05
Sales	124		\$6,528.05	124	\$6,528.05
Refund	0		\$0.00	0	\$0.00
Card decline after host approval	2		\$89.00	2	\$89.00
Card pre-decline (report to host)	8		\$895.00	8	\$895.00

Page 1 of 2

Settlement Status: **BALANCED**

Unpaid Transactions Report

The Unpaid Transactions Report provides information on transactions that result in a declined or unsettled completion or transactions that are authorized but later declined by the NBS network. The Passport system attempts to obtain a response from the NBS network for offline completions until a response is received or a Store Close is performed.

Figure 37: Unpaid Transactions Report

Unpaid Transactions				
PERIOD FROM 12/26/2016 6:19:07 AM TO 1/3/2017 12:48:03 PM				
Date/Time	Account Number	Sales Type	Total	Transaction #
2017-01-03 08:04:46	XXXXXXXXXXXX1005	Inside-	\$42.00	10145
2017-01-03 09:39:50	XXXXXXXXXXXX1005	Inside-	\$49.00	10152
2017-01-03 09:41:46	XXXXXXXXXXXX2513	Inside-	\$50.00	10153

Site Level Card Based Fuel Discounts

This report provides information on the fuel discounts by card type configured by going to **MWS > Set Up > Network Menu > NBS > Fuel Discount Configuration**. It lists each card type the network accepts, and the Fuel Discount Group assigned to the card type, or NONE if the card type has no discount configured.

Figure 38: Site Level Card Based Fuel Discounts

Site Level Card Based Fuel Discounts	
Report created: 01/02/2017 12:18:23 PM	
Card Record	Discount Group
American Express	NONE
Carte Blanche	NONE
Cenex	NONE
Cenex Gift Card	NONE
Debit	NONE
Diners Club	NONE
Discover/Novus	NONE
Fleet One	NONE
Fuel Man	NONE
GasCard	NONE
JCB	NONE
MasterCard	NONE
MasterCard Fleet	NONE
Sinclair Fleet	NONE
Visa	NONE
Visa Fleet	NONE
Voyager	NONE
Wright Express	NONE

Network Journal Report

The Network Journal Report provides information on NBS network transactions.

The following transaction types are recorded in the Network Journal Report:

- Credit Sales
- Debit Sales
- EBT Sales
- Prepaid Card Activations
- Prepaid Card Recharges
- Prepaid Card Declines (when the NBS network sends the decline code)
- Card Configuration Download Tracking
- EMV Download Tracking
- EMV Transaction detail

The Network Journal Report indicates Shift and Day Close status. It also provides reporting on network communications, such as approval and denial for all services.

The Network Journal Report is available by navigating to **MWS > Reports > Journal Reports > Network Journal Report**. The Network Journal Report User Interface allows the user to configure parameters, such as date and time, exceptions, source of the transactions, type of transaction, and sorting order.

Figure 39: Network Journal Selection Screen

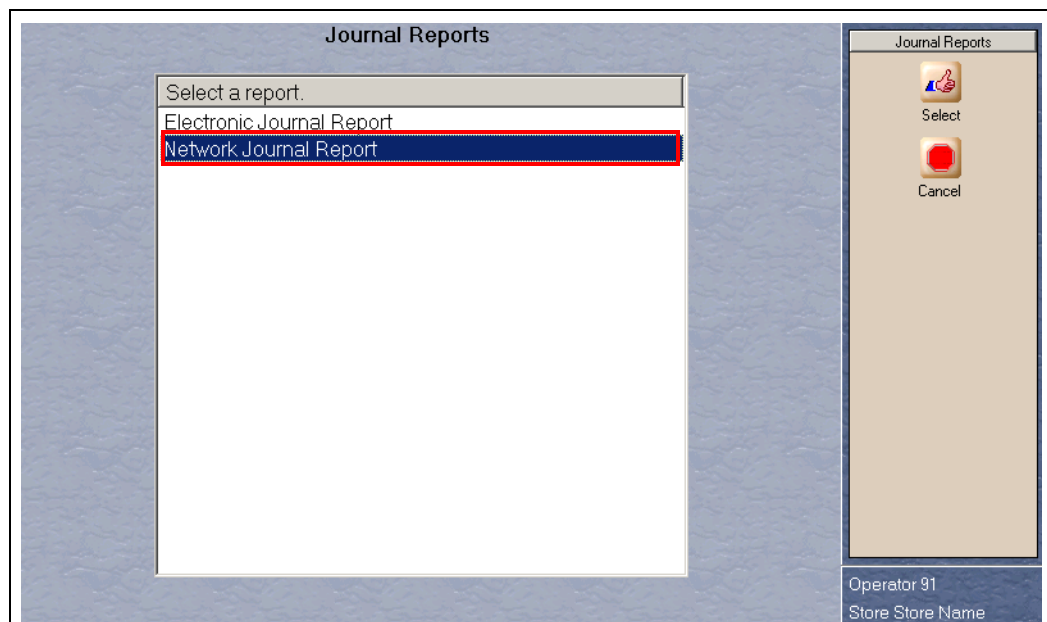

Note: The store manager can use the Network Journal Report as an aid for identifying disputed transactions.

Figure 40: Network Journal Pre-Filter Screen

Network Journal Report

Date/Time

Current Date 12/02/2016

Select

11/25/2016 06:10:24

to

12/01/2016 12:35:25

December 2016

S	M	T	W	T	F	S
27	28	29	30	1	2	3
4	5	6	7	8	9	10
11	12	13	14	15	16	17
18	19	20	21	22	23	24
25	26	27	28	29	30	31
1	2	3	4	5	6	7

Exception Flag

Exception Transaction All

Journal Text

Source ID (Register \ CRIND \ Other)

All

Select

OtherSource
Register # 1
Register # 2

Journal Type

All

Select

EMV Conf Download
Download Configuration
Approved Transactions
EMV Transaction Details
Batch Settlement
Period Close
Declined Transactions

Sort By

Timestamp Ascending Descending

Network Journal Report

Operator 91

CWS Network Functions

To access the CWS Network Functions, proceed as follows:

- 1 From the CWS idle screen, select **More** until the Network Functions button appears.
~ OR ~
Select **Network Status**. The Network Functions screen opens.

Figure 42: More > Network Functions

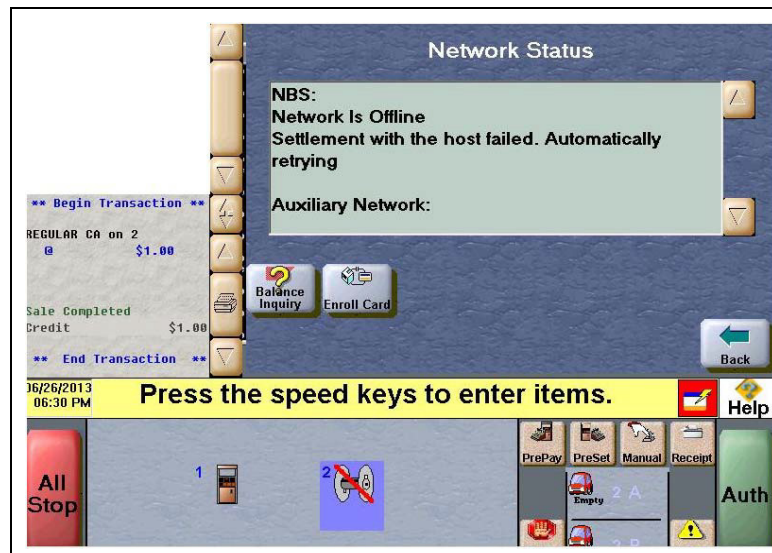

Figure 43: CWS Network Status



With either of the actions, the Network Status screen opens.

Figure 44: Network Status Screen



The Network Status screen provides information on all networks connected to the Passport system.

Checking Network Status

The Network Status screen allows you to view a record of network events such as communication errors. Each network event is assigned a severity rating (low, medium, or high). The network status is updated every time a new event is added to the list. The color of the Network Status button indicates the severity of the event:

Color	Severity
Green	Low
Yellow	Medium
Red	High

If multiple events occur, the color of the Network Status button indicates the highest severity rating of the events. The Network Status button color changes when an event is corrected or after a predetermined time.

The following table describes the Network Functions buttons and their behavior:

Button	Behavior
Balance Inquiry	When this button is selected, the Passport system prompts the user to swipe the customer's Cash Card. After the service runs successfully, the Passport system displays the customer balance. <i>Note: This function is applicable to Cash Cards only.</i>
Enroll Card	When this button is selected, the Passport system guides the cashier through the process of enrolling a card in the NBS Loyalty program.

Appendix A: Cenex® Fuel Product Codes

The following table lists the Cenex Fuel Product Codes to be used in the Passport system. To associate the correct product code with a specific fuel grade, click **Assign Network Codes** in **MWS > Set Up > Forecourt > Forecourt Installation**.

For stores other than Cenex, coordinate with NBS directly to determine if special programming is required.

Fuel Grade	PCATS Product Code	Comments
Unlead 87	001	-
Unlead 88-89	002	-
Unles 90-91	003	-
Unlead 92/above	004	-
Ethl 5.7% 87/88	011	California product
Ethl 5.7% 89/90	012	Currently inactive
Ethl 5.7% 91/92	013	-
Ethl 7.7% 87/88	014	-
Ethl 7.7% 89/90	015	-
Ethl 7.7% 91/92	041	-
Ethl 10% 87/88	042	-
Ethl 10% 89/90	043	-
Ethl 10% 91/92	044	-
M85	025	-
E85	026	-
Unld Refm 87/88	027	-
Unld Refm 89/90	028	-
Unld Refm 91/92	029	-
Misc Auto Fuel	099	-
Diesel # 1	019	-
Diesel # 2	020	-
Diesel Premium	021	-
Diesel B2	045	-
Diesel B5	046	-
Diesel B10	047	-
Diesel B20	050	-
ULS Diesel # 2	079	-
ULS Diesel B2	080	-
ULS Diesel B5	081	-
ULS Diesel B10	082	-
ULS Diesel B20	083	-
Diesl #1 No Tax	032	-
Diesl #2 No Tax	033	-
Diesl Prm No Tax	034	-
Diesel B2 N/Tax	074	-

Fuel Grade	PCATS Product Code	Comments
Diesel B5 N/Tax	075	-
Diesel B10 N/Tax	078	-
Diesel B20 N/Tax	076	-
ULS Diesel B2 N/Tax	084	-
ULS Diesel B5 N/Tax	085	-
ULS Diesel B10 N/Tax	086	-
ULS Diesel B20 N/Tax	087	-
Flexfuel Ethnl	088	-
Othr ful No Tax	035	-
Cmpr naturl Gas	022	-
LPG motorFuel	023	-
Liquid Nat Gas	024	Currently inactive
Kerosene	300	-

Appendix B: Upgrading to Passport V12

This section provides Irving-specific information to the ASC when upgrading from a Passport version which has been defined as an approved upgrade path.

Before beginning the upgrade, the ASC must perform the following:

- Do not replace or add a PIN pad until after the upgrade completes. Refer to “After the upgrade” section for instructions in case of specific PIN pad models.
- Ensure that all dispenser software and firmware meet applicable requirements to support loyalty and other fuel discounting functionality (including support of \$0.000 PPU).
- Print the **Network Configuration Report**. This will be helpful if a clean install is required and to confirm all network settings (including Host Connection Type and other parameters in Global Information).
- Perform Store Close and ensure that all network transactions have completed. Call NBS Help Desk at 1-800-827-4634 to verify that the period was closed successfully.
- Assist the merchant or store manager to print all additional accounts and network reports which are required.
- Ensure that all file transfers from Passport to the BOS have completed.

Secure Zone Router

To install SZR, proceed as follows:

- On the Passport Loyalty Configuration screen, change the Host IP Address to 192.168.70.26.
- Call the Excentus Help Desk at 1-877-445-9713 to reprogram the Irving Rewards Systech box to 192.168.70.26.
- Call Trustwave® at 1-888-949-7328 to update the firewall to the Gold image for the SZR.
- Install the SZR. Refer to [Appendix C: Network Topology at Irving Sites](#) and *MDE-5382 Secure Zone Router (Acumera) Installation Instructions*.

After the upgrade, the ASC must perform the following:

- If the store uses Dial, set Baud Rate value to 9600 at dial configuration screen. To set the baud rate, go to **MWS > Set Up > Network Menu > NBS > Site Configuration > Dial Configuration > Page 1**.
- Enable EMV in MWS with at least one PIN pad set to “EMVCapable”.
- Request a Card Download by going to **MWS > Set Up > Network Menu > NBS > PDL Download**. For more information on requesting PDL Download, refer to “[Requesting Card Configuration Download](#)” on [page 17](#).
- Request an EMV PDL Download by going to **MWS > Set Up > Network Menu > NBS > EMV PDL Download**. For more information on requesting EMV PDL Download, refer to “[Requesting EMV PDL Download](#)” on [page 19](#).
- Review the parameters on **MWS > Set Up > Network Menu > NBS > Site Configuration > EMV Parameters** tab with the store owner or store manager. Advise the store owner or manager to contact NBS Help Desk to discuss the financial implications and suggested settings on this screen.
- If installing a VeriFone MX915 or Ingenico iSC250/iPP320 PIN Pad after the upgrade, ensure that the EMV Capable field is selected in **MWS > Set Up > Register > Register Set Up > Device Configuration**.

Appendix C: Network Topology at Irving Sites

Figure 45: Passport Network Diagram

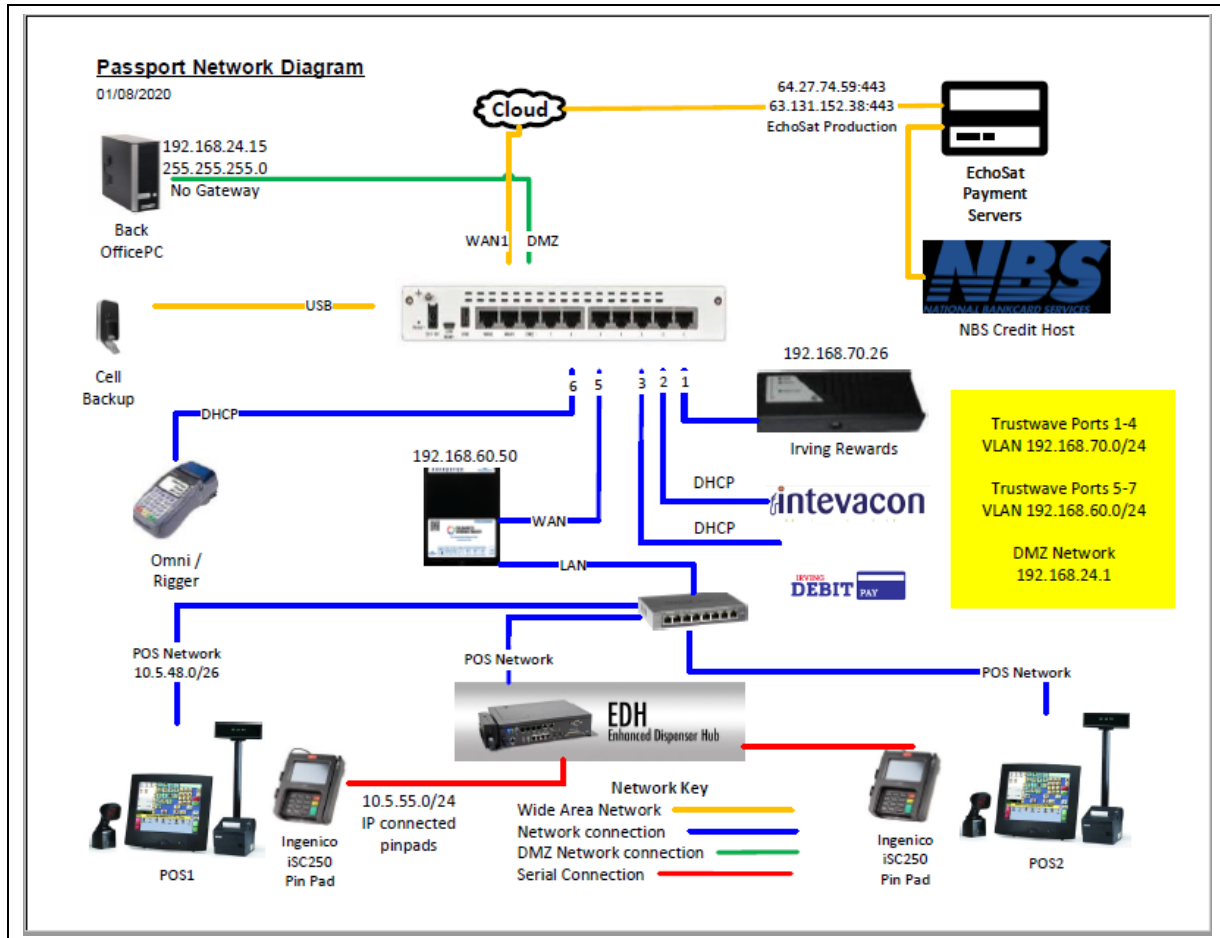

American Express® is a registered trademark of American Express Company. Cenex® is a registered trademark of CHS Inc. Cisco® is a registered trademark of Cisco Systems Inc. Comcast® is a registered trademark of Comcast Corporation. CRIND®, Gilbarco®, and Passport® are registered trademarks of Gilbarco Inc. Diners® is a registered trademark of Citicorp Diners Club Inc. DiscoverSM is a service mark of Novus Credit Services Inc. EMV® is a registered trademark of EMVCo LLC. Epson® is a registered trademark of Seiko Epson Corporation. Europay® and MasterCard® are registered trademarks of MasterCard International Inc. Fleet OneSM is a service mark of Fleet Financial Group Inc. FlexPay™ and Insite360™ are trademarks of Gilbarco Inc. FuelMan® is a registered trademarks of FleetCor Technologies Operating Company LLC. GOLDSM is a service mark of Gilbarco Inc. Impulse™ is a trademark of Odysii. Ingenico® is a registered trademark of Groupe Ingenico. Irving Oil® is a registered trademark for Irving Oil Corporation. Mannatec® is a registered trademark of FleetCor Technologies Operating Company LLC. MultiTech® is a registered trademark of Multi-Tech Systems Inc. NBS® is a registered trademark of National Bankcard Services Inc. Trustwave® is a registered trademark of Trustwave Holdings, Inc. Veeder-Root® is a registered trademark of Veeder-Root Company. VeriFone® is a registered trademark of VeriFone Inc. Visa® is a registered trademark of Visa Inc. Voyager® is a registered trademark of U.S. Bancorp Licensing Inc. Wright Express® is a registered trademark of Wright Express Financial Services Corporation.

© 2020 Gilbarco Inc.
7300 West Friendly Avenue · Post Office Box 22087
Greensboro, North Carolina 27420
Phone (336) 547-5000 · <http://www.gilbarco.com> · Printed in the U.S.A.
MDE-5518A Passport™ V12 Network Addendum for Irving Oil® · March 2020

