

TLS-3XX Series Consoles

Operator's Manual

Notice

Veeder-Root makes no warranty of any kind with regard to this publication, including, but not limited to, the implied warranties of merchantability and fitness for a particular purpose.

Veeder-Root shall not be liable for errors contained herein or for incidental or consequential damages in connection with the furnishing, performance, or use of this publication.

Veeder-Root reserves the right to change system options or features, or the information contained in this publication.

This publication contains proprietary information which is protected by copyright. All rights reserved. No part of this publication may be photocopied, reproduced, or translated to another language without the prior written consent of Veeder-Root.

Contact TLS Systems Technical Support for additional troubleshooting information at 800-323-1799.

DAMAGE CLAIMS / LOST EQUIPMENT

Thoroughly examine all components and units as soon as they are received. If any cartons are damaged or missing, write a complete and detailed description of the damage or shortage on the face of the freight bill. The carrier's agent must verify the inspection and sign the description. Refuse only the damaged product, not the entire shipment.

Veeder-Root must be notified of any damages and/or shortages within 30 days of receipt of the shipment, as stated in our Terms and Conditions.

VEEDER-ROOT'S PREFERRED CARRIER

1. Contact Veeder-Root Customer Service at 800-873-3313 with the specific part numbers and quantities that were missing or received damaged.
2. Fax signed Bill of Lading (BOL) to Veeder-Root Customer Service at 800-234-5350.
3. Veeder-Root will file the claim with the carrier and replace the damaged/missing product at no charge to the customer. Customer Service will work with production facility to have the replacement product shipped as soon as possible.

CUSTOMER'S PREFERRED CARRIER

1. It is the customer's responsibility to file a claim with their carrier.
2. Customer may submit a replacement purchase order. Customer is responsible for all charges and freight associated with replacement order. Customer Service will work with production facility to have the replacement product shipped as soon as possible.
3. If "lost" equipment is delivered at a later date and is not needed, Veeder-Root will allow a Return to Stock without a restocking fee.
4. Veeder-Root will NOT be responsible for any compensation when a customer chooses their own carrier.

RETURN SHIPPING

For the parts return procedure, please follow the appropriate instructions in the "General Returned Goods Policy" pages in the "Policies and Literature" section of the Veeder-Root **North American Environmental Products** price list. Veeder-Root will not accept any return product without a Return Goods Authorization (RGA) number clearly printed on the outside of the package.

WARRANTY

Please see next page, iii.

Warranty

TLS-350R, TLS-350 PLUS, TLS-350J AND TLS-300I/C, AND TLS-2 MONITORING SYSTEMS.

We warrant that this product shall be free from defects in material and workmanship for a period of one (1) year from the date of installation or twenty-four (24 months) from the date of invoice, whichever occurs first. During the warranty period, we or our representative will repair or replace the product, if determined by us to be defective, at the location where the product is in use and at no charge to the purchaser. LAMPS AND FUSES ARE NOT COVERED UNDER WARRANTY.

We shall not be responsible for any expenses incurred by the user.

This warranty applies only when the product is installed in accordance with Veeder-Root's specifications, and a Warranty Registration and Checkout Form has been filed with Veeder-Root by an authorized Veeder-Root Distributor. This warranty will not apply to any product which has been subjected to misuse, negligence, accidents, systems that are misapplied or are not installed per Veeder-Root specifications, modified or repaired by unauthorized persons, or damage related to acts of God.

If "Warranty" is purchased as part of the Fuel Management Service, Veeder-Root will maintain the equipment for the life of the contract in accordance with the written warranty provided with the equipment. A Veeder-Root Fuel Management Services Contractor shall have free site access during Customer's regular working hours to work on the equipment. Veeder-Root has no obligation to monitor federal, state or local laws, or modify the equipment based on developments or changes in such laws.

MODULES, KITS, OTHER COMPONENTS (PARTS PURCHASED SEPARATE OF A COMPLETE CONSOLE).

We warrant that this product shall be free from defects in material and workmanship for a period of fifteen (15) months from date of invoice. We will repair or replace the product if the product is returned to us; transportation prepaid, within the warranty period, and is determined by us to be defective. This warranty will not apply to any product which has been subjected to misuse, negligence, accidents, systems that are misapplied or are not installed per Veeder-Root specifications, modified or repaired by unauthorized persons, or damage related to acts of God.

We shall not be responsible for any expenses incurred by the user.

1 Introduction	
Related Manuals	1-1
Safety Symbols	1-1
Safety Warnings	1-2
Regulatory Compliance and Approvals	1-2
Console	1-3
Monitoring Functions	1-3
Input/Output Functions	1-4
Communications Functions	1-4
Console Options	1-4
Continuous Statistical Leak Detection (CSLD)	1-4
Volumetric Line Leak Detection System	1-4
Pressurized Line Leak Detection System	1-4
Wireless Pressurized Line Leak Detection System	1-4
Fuel Management	1-5
Business Inventory Reconciliation	1-5
Maintenance History - TLS-350 Only	1-5
Maintenance TrackER - TLS-350 Only	1-6
PC Interface Software Options	1-6
Inform	1-6
Alarm Message Quick Reference Index	1-6
2 Basic Operation	
Operating Mode Functions	2-1
Steps	2-1
Operating Mode Functions	2-1
Setup Mode	2-6
Reconciliation Mode (TLS-350R Only)	2-6
Diagnostic Mode	2-6
3 Front Panel Keypads	
Description	3-1
Operating KeyPad	3-1
Alphanumeric KeyPad	3-1
Operating Key Functions	3-2
Alarm/Test	3-2
Mode	3-2
Function	3-2
Step	3-2
Tank/Sensor	3-2
Change	3-2
Enter	3-2
Backup	3-2
Print	3-2
Blue Key (Maintenance Tracker - TLS-350 Only)	3-2
White Key (Maintenance Report - TLS-350 Only)	3-3
Alphanumeric Entries	3-3
Cursor Keys	3-3

4 In-Tank Inventory	
Printing In-Tank Inventory	4-1
Fuel Height	4-2
Water Volume	4-2
Water Height	4-3
Fuel Temperature	4-3
Ullage	4-3
Temperature Compensated Volume	4-4
Delivery Increase Amount	4-4
Density (Optional Feature)	4-5
To Enter a Delivered Product's Density.....	4-5
5 Delivery Maintenance	
Editing Ticketed Deliveries	5-1
Inserting Ticketed Deliveries	5-2
Printing Delivery Reports	5-3
6 Tanker Load Report	
All Tanks	6-1
Specific Tanks	6-1
Single Tank and Load Number	6-1
7 Fuel Management	
Short Report	7-1
Days Fuel Remaining	7-1
Inventory	7-2
95% Ullage	7-2
Average Daily Sales	7-2
8 Last-Shift Inventory	
Beginning Inventory	8-1
End Inventory	8-1
Delivery Adjustment	8-2
Gross Change	8-2
Close Current Shift Now	8-2
9 In-Tank Test Results	
Gross Test Results	9-1
Periodic Test Results	9-2
Annual Test Results	9-2
10 CSLD Test Results	
TLS-3XX Consoles	10-1
TLS-350 Plus/TLS-350R Consoles	10-1
11 PLLD Tests	
3.0 gph (11.3 lph) Tests	11-1
0.2 gph (0.76 lph) Tests	11-2
0.1 gph (0.38 lph) Tests	11-2
History Reports	11-2
Start Pressurized Line Leak Test	11-3
Select All Lines or a Single Line	11-3
Select Test Type.....	11-3

Start Test	11-4
Stop Pressurized Line Leak Test	11-4
All Lines	11-4
Single Line	11-4
12 WPLLD Tests	
3.0 gph (11.3 gph) Tests	12-1
0.2 gph (0.76 lph) Tests	12-2
0.1 gph (0.38 lph) Tests	12-2
History Reports	12-2
Start Wireless Pressurized Line Leak Test	12-3
Select All Lines or a Single Line	12-3
Select Test Type	12-3
Start Test	12-3
Stop Wireless Pressurized Line Leak Test	12-4
All Lines	12-4
Single Line	12-4
13 VLLD Tests	
Test Reports	13-1
0.2 gph Tests	13-1
0.1 gph Tests	13-1
Start Volumetric Line Leak Test	13-2
All Lines	13-2
Single Line	13-2
Air Purge	13-3
Purging Air from All Lines	13-3
Purging Air from a Single Line	13-4
Stop Volumetric Line Leak Tests	13-5
All Lines	13-5
Single Line	13-5
14 Pump Relay Monitor Status Reports	14-1
15 Liquid Status Reports	15-1
16 Vapor Sensor Status	
Vapor Sensor Alarms	16-1
Vapor Sensor Status Reports	16-1
17 Groundwater Sensor Status	
Groundwater Sensor Alarms	17-1
Groundwater Sensor Status Reports	17-1
18 2-Wire C.L. Status	
2-Wire C.L. Status Reports	18-1
2-Wire C.L. Status Alarms	18-1
19 3-Wire C.L. Status	
3-Wire C.L. Status Reports	19-1
3-Wire C.L. Status Alarms	19-1

20 In-Tank Leak Detection Test	
Regulatory Compliance	20-1
What To Do If You Detect A Leak	20-1
Inventory Control Practices	20-1
Preparation	20-1
Testing All Tanks for a Timed Duration	20-2
Testing All Tanks Using Manual Control	20-3
Testing Single Tanks for a Timed Duration	20-4
Testing Single Tanks using Manual Control	20-5
Test Results	20-6
21 How To Stop In-Tank Leak Tests	
All Tanks	21-1
Single Tank	21-1
22 Test Output Relays	22-1
23 Mag Sump Sensor Leak Test Results	23-1
24 Start Mag Sump Sensor Leak Test	
Mag Sump Sensor Leak Test	24-1
Mag Sump Leak Test Abort Conditions	24-1
Stopping a Mag Sump Leak Test	24-2
Temperature Stability	24-2
Leak Rate Calculation	24-2
Mag Sump Leak Test Status Messages	24-2
Starting a Leak Test	24-3
Stopping a Leak Test	24-5
25 Smart Sensor Status	25-1
26 VMC Status Reports	26-1
27 Diagnostic Mode	
Service Report	27-1
In-Tank Leak Test Results	27-1
0.2 gph (0.76 lph) Leak Test Results	27-1
0.1 gph (0.38 lph) Leak Test Results	27-2
Last Test Date and Time	27-2
Leak Rate	27-2
Print Leak History	27-2
CSLD Monthly Report	27-3
Alarm History Reports	27-3
System Alarm History Report	27-4
In-Tank Alarm History Report	27-4
Liquid Sensor Alarm History Report	27-4
Vapor Sensor Alarm History Report	27-4
External Input Alarm History Report	27-4
Volumetric Line Leak Alarm History Report (TLS-350 Plus/TLS-350R Only)	27-5
Groundwater Alarm History Report	27-5
2-Wire C.L. (Type A Sensors) Alarm History Report	27-5
Other Sensors Alarm History Report	27-5
3-Wire C.L. (Type B Sensors) Alarm History Report	27-5
Pressure Line Leak (PLLD) Alarm History Report	27-6

Wireless Pressure Line Leak (WPLLD) Alarm History Report.....	27-6
Smart Sensor Alarm History Report	27-6
Pump Relay Monitor Alarm History Report.....	27-6
VMCI Interface Module Alarm History Report	27-6
VMC Controller Alarm History Report.....	27-7
Fuel Management Diagnostics	27-7
Average Sales	27-8
Last Sales.....	27-8
Predicted Sales	27-8

28 Reconciliation Mode

Manual Shift Close	28-1
Reconciliation Reports	28-2
All Products and All Shifts	28-2
Daily.....	28-3
Periodic.....	28-4
Periodic Report for Current or Previous Period	28-4
Displaying Periodic Report Activities	28-5
Shift Report for a Selected Product — All Shifts	28-5
Shift Report for Current or Previous Shift	28-6
Displaying Shift Activities.....	28-6
Variance Reports	28-6
Delivery Variance Reports.....	28-6
Book Variance Reports.....	28-10
Variance Analysis Reports	28-14
Sample Variance Analysis Report.....	28-18
How to Manually Adjust Reconciliation Reports	28-19
Shift Adjustment	28-19
Daily Adjustment.....	28-19
Adjusted Delivery Reports	28-20
Single Tank Adjusted Delivery Sample Report	28-20
Manifolded Tanks Adjusted Delivery Sample Report	28-20

29 Troubleshooting

Calling for Help	29-1
Warnings and Alarms	29-1
Audible Alarm	29-1
Warning Lights.....	29-1
Messages	29-1
Alarm Reports.....	29-1
Warning and Alarm Messages	29-2
Servicing Solid State and Dual Float Discriminating Sensors	29-19
VLLD Troubleshooting	29-19
Self Test Failure Reports.....	29-19
3.0 GPH Test Failure.....	29-20
Precision Test Failure.....	29-21
Leak Verification Procedure	29-21

30 Changing Printer Paper

To change the paper roll	30-1
--------------------------------	------

31 System Periodic Maintenance Checklist

31-1

32 Maintenance Report - TLS-350 Only	
Maintenance Report	32-1
Maintenance History - TLS-350 Only	32-1
Printing Out the Maintenance Report	32-2
To Print Specific Maintenance Records	32-3
33 Maintenance Tracker - TLS-350 Only	
Using Maintenance Tracker	33-1

Figures

Figure 1-1. Example Console Front Panel	1-3
Figure 3-1. Console keypad	3-1
Figure 24-1. Example printout of leak test in progress - Measuring Height Phase.....	24-5
Figure 24-2. Example printout of an aborted test	24-6
Figure 30-1. Paper change 1	30-1
Figure 30-2. Paper change 2	30-1
Figure 30-3. Paper change 3	30-2
Figure 30-4. Paper change 4	30-2
Figure 32-1. Maintenance Report key on front panel	32-1
Figure 32-2. Maintenance Report printout example	32-2
Figure 33-1. Maintenance Tracker key on front panel	33-1

Tables

Table 1-1.- System Device Code	1-7
Table 1-2.- Alarm Message Quick Reference Index	1-7
Table 20-1.- Minimum In-Tank Leak Test Times	20-1
Table 29-1.- Device Codes and Descriptions	29-2
Table 29-2.- System Status Displayed Messages	29-3
Table 29-3.- In-Tank Leak Detection Displayed Messages	29-4
Table 29-4.- In-Tank Leak Detection Invalidation Criteria	29-6
Table 29-5.- Liquid Sensor Status Indicators - Piping Sump, Steel or Fiberglass Tank Interstitial Sensors	29-6
Table 29-6.- Liq. Sensor Status - Normally Closed Sensors	29-7
Table 29-7.- Liq. Sensor Status - Dual Float Differentiating (Hydrostatic) Sensors	29-7
Table 29-8.- Liq. Sensor Status - Dual Float Discriminating	29-7
Table 29-9.- Vapor Sensor Status Indicators	29-8
Table 29-10.- Receiver Status Indicator	29-9
Table 29-11.- Pressurized Line Leak Detector Status Indicators	29-9
Table 29-12.- Wireless Pressurized Line Leak Detector Status Indicators	29-11
Table 29-13.- Volumetric Line Leak Detector Status Indicators	29-12
Table 29-14.- Groundwater Sensor Status Indicators	29-14
Table 29-15.- 2-Wire C.L. Discriminating Interstitial Sensor Status Indicators	29-14
Table 29-16.- 2-Wire C.L. Discriminating Interstitial Micro Sensor Status Indicators	29-15
Table 29-17.- 3-Wire C.L. Sensor Status Indicators	29-15
Table 29-18.- External Input Messages	29-16
Table 29-19.- Business Inventory Reconciliation (BIR) Messages*	29-16
Table 29-20.- Smart Sensor Status Indicators	29-17
Table 29-21.- Pump Relay Monitor Message	29-18
Table 29-22.- VMCi Interface Module Messages*	29-18
Table 29-23.- VMC (Vapor Monitor Controller) Messages*	29-18

1 Introduction







This manual details viewing/printing instructions for every available TLS-3XX console operation mode function. The manual is divided into sections for each operation mode function beginning with Section 4, In-Tank Inventory. Depending on your console type and its installed features, you may only see (and be able to access) some of the functions and/or steps. Just skip over the material in this manual that does not apply to your particular installation. The procedures in this manual assume that your system has already been set up by a Certified Contractor.

Related Manuals

576013-623	TLS-3XX Series Consoles Setup Manual
576013-879	TLS-3XX Series Consoles Site Prep Manual
577013-874	Maintenance Service Codes

Safety Symbols

The following safety symbols may be used throughout this manual to alert you to important safety hazards and precautions.

 <p>EXPLOSIVE Fuels and their vapors are extremely explosive if ignited.</p>	 <p>FLAMMABLE Fuels and their vapors are extremely flammable.</p>
 <p>ELECTRICITY High voltage exists in, and is supplied to, the device. A potential shock hazard exists.</p>	 <p>TURN POWER OFF Live power to a device creates a potential shock hazard. Turn Off power to the device and associated accessories when servicing the unit.</p>
 <p>WARNING Heed the adjacent instructions to avoid equipment damage or personal injury.</p>	 <p>READ ALL RELATED MANUALS Knowledge of all related procedures before you begin work is important. Read and understand all manuals thoroughly. If you do not understand a procedure, ask someone who does.</p>

Safety Warnings

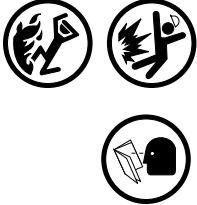
⚠ WARNING	
	<p>This system operates near highly combustible fuel storage tanks.</p> <p>Fire or explosion resulting in serious injury or death could result if the equipment is improperly installed or modified or is used in any way other than its intended use. Serious contamination of the environment may also occur.</p> <p>To ensure proper installation, operation, and continued safe use of this product:</p> <ol style="list-style-type: none"> 1. Read and follow all instructions in this manual, including all safety warnings. 2. To be installed in accordance with the National Electrical Code, NFPA 70 and the Code for Motor Fuel Dispensing Facilities and Repair Garages (NFPA 30A). 3. For use with peripheral devices which are UL Listed, have an EIA RS232C (or RS422A) communication protocol, and are not installed over a hazardous location. 4. Do not modify or use service parts other than those provided by Veeder-Root. 5. Substitution of components may impair intrinsic safety.

⚠ WARNING	
	<p>This system operates near potentially hazardous fuel storage tanks.</p> <p>Leaking tanks can create serious environmental and health hazards. Improper programming and operation may also result in equipment self-test failures and submersible pump shutdowns.</p> <p>FAILURE TO COMPLY WITH THE FOLLOWING WARNINGS AND SAFETY PRECAUTIONS COULD CAUSE DAMAGE TO PROPERTY, ENVIRONMENT, RESULTING IN SERIOUS INJURY OR DEATH.</p> <p>It is the owner's responsibility to:</p> <ol style="list-style-type: none"> 1. Ensure that this equipment is properly programmed. 2. Promptly investigate any alarm conditions. 3. Operate this equipment in accordance with the instructions in this manual.

Regulatory Compliance and Approvals

Plan your leak detection program to comply with local, state, and federal regulations governing underground storage tanks. Save all inventory and leak test records provided by the system as part of a regulatory compliance program.

The system, when equipped with Series 8473, 0.2 gallon-per-hour (gph) magnetostrictive probes, is classified as an Automatic Tank Gauge System and has been third-party tested by Midwest Research Institute. This system can detect a 0.2 gph leak exceeding a 95% probability of detection [P(D)] and a 5% probability of false alarm [P(FA)]. It meets federal U.S. E.P.A. performance standards (0.2 gph at [P(D)] of 95% and [P(FA)] of 5%) and the federal performance standard of measuring water in the bottom of a tank to the nearest 1/8 inch.

The system, when equipped with Series 8473, 0.1 gph magnetostrictive probes, meets Volumetric Tank Tightness Testing Method standards and has been third-party tested by Midwest Research Institute. This system can detect a 0.2 gph leak exceeding a 95% probability of detection [P(D)] and a 1% probability of false alarm [P(FA)]. This system meet U.S. E.P.A. federal performance standards (0.20 gph at [P(D)] of 95% and [P(FA)] of 5%).

Console

Console temperature ranges:

- Operating: 32 to 104°F (0 to 40°C)
- Storage: -40 to 162°F (-40 to +74°C)

Console features (see Figure 1-1):

- Display
- Keypads for programming, operating and reporting functions
- Power-on, Warning and Alarm Indicator lights
- Internal beeper provides audible warning and alarm alerts
- Optional printer for inventory, leak detection, alarm and setup printouts.

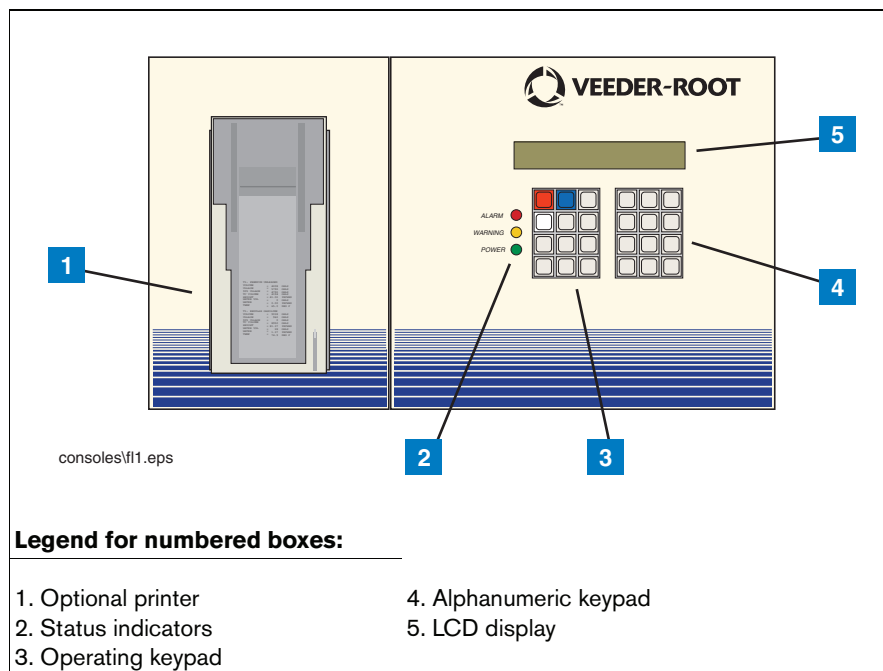

Figure 1-1. Example Console Front Panel

Monitoring Functions

Depending on options and installed equipment, the console can provide:

- Inventory control
- In-tank leak detection and interstitial leak sensing
- Line leak detection
- Groundwater monitoring wells for the presence of hydrocarbons.
- Dry monitoring wells for the presence of hydrocarbon vapors.

- Interstitial space vacuum leak detection
- Maintenance History logs
- Maintenance Tracking and Control

Input/Output Functions

Input functions allow other devices, such as a generator or burglar alarm, to be connected to the console. Once connected, these devices can use the alarm, reporting and communications functions in the system.

Output functions are provided by relays installed in the console. They can trigger external alarm devices when an alarm condition is sensed by the system.

Communications Functions

Several communications options are available for your console:

- RS-232
- Modem
- TCP/IP Interface
- Remote Printer Interface

Console Options

The options shown below may or may not be installed in your console.

CONTINUOUS STATISTICAL LEAK DETECTION (CSLD)

CSLD eliminates the need to stop dispensing fuel to run in-tank leak tests by identifying and collecting information during idle times or periods. CSLD provides 24-hour, 0.2 gph leak detection without requiring tank shutdown (0.1 gph Mag probe required for each tank). Information is updated constantly for accurate leak detection. CSLD meets federal, state and local compliance requirements for monthly monitoring. Test results showed a 99% probability of detection and less than a 0.1% chance of false alarm.

VOLUMETRIC LINE LEAK DETECTION SYSTEM

The Volumetric Line Leak Detection (VLLD) System performs leak tests on pressurized lines at test rates of 3.0 gph, 0.2 gph, and 0.1 gph.

PRESSURIZED LINE LEAK DETECTION SYSTEM

The Pressurized Line Leak Detection (PLLD) System is a patented, highly accurate, electronic line leak detection system to test lines at full pump pressure for 0.1 gph (optional), or 0.2 gph (optional), and 3.0 gph (standard).

WIRELESS PRESSURIZED LINE LEAK DETECTION SYSTEM

The Wireless Pressurized Line Leak Detection (WPLLD) System is a patented, highly accurate, electronic line leak detection system to test lines at full pump pressure for test rates of 0.1 gph (optional), or 0.2 gph (optional), and 3.0 gph (standard). Unlike PLLD, this system communicates over existing pump wires and AC lines.

FUEL MANAGEMENT

The Fuel Management function lets you estimate the number of days remaining before you receive a Low Product alarm. It also keeps track of each product's average daily sales, which you can display or print. The starting inventory minus ending inventory, plus deliveries determine the sales for each day of the week. Using this data, the system calculates the estimated number of days of product remaining.

BUSINESS INVENTORY RECONCILIATION

Business Inventory Reconciliation (BIR) provides automatic inventory capability. It collects metered transactions, in-tank inventories and deliveries, then reconciles the totals at the end of each shift, day, or period. BIR can also be used on line manifolded tanks (Version 1xx or 3xx software) and siphon manifolded tanks (Version 3xx software only). You can print reconciliation reports automatically or on demand.

AccuChart™

AccuChart is a patented, automatic tank calibration process which reduces inventory reconciliation errors by improving tank chart accuracy. By comparing metered dispensed volumes to tank probe heights, AccuChart minimizes heights-to-volume conversion errors by adjusting the tank parameters; capacity, diameter, tilt, and end shape, and the probe offset parameter.

For 56 days after initial startup, or after a system restart, the system conducts automatic tank calibration over typical operating levels in the tank as fuel is dispensed. *During this 56-day period it is recommended that the tank be filled and allowed to drain down as low as possible for three tankfuls* to allow the software to calculate an accurate tank profile. Each time an AccuChart calibration is updated, a user notification message is sent to the local printer.

The AccuChart program is initiated during system setup and requires no operator input.

Automatic Tank-To-Meter Mapping

Tank-To-Meter Mapping assigns each product hose to the correct tank, eliminating reconciliation errors by manually mapping a meter to the wrong tank.

MAINTENANCE HISTORY - TLS-350 ONLY

Contains a rolling 3 year history of the following maintenance records:

- Active Alarm (alarm post) – alarm type and number, device number, active date/time. This includes protected maintenance alarms.
- Inactive Alarm (alarm clear) – alarm type and number, device number, inactive date/time. This includes protected maintenance alarms.
- Maintenance History enable – date/time of enable.
- Maintenance History disable – date/time of disable.
- Service codes – service code, date/time entered.
- Last Monthly Fullest Periodic Tank Test Passed – tank number, start date/time.
- Last Monthly PLLD 0.2 GPH Test Passed – tank number, date/time entered (record added at 1st of next month).
- Last Monthly WLLD 0.2 GPH Test Passed – tank number, date/time entered (record added at 1st of next month).
- Last Monthly VLLD 0.2 GPH Test Passed – tank number, date/time entered (record added at 1st of next month).

MAINTENANCE TRACKER - TLS-350 ONLY

With the required hardware installed, a Contractor must connect a valid ID key to the console prior to beginning a maintenance work session. This feature restricts access to setup mode and diag mode, and records each logged in work session in the Maintenance History log. In addition, Maintenance Tracker also adds the following records to the Maintenance History report in addition to Maintenance History records:

- MT login
- MT logout
- Maintenance Tracker Protected Alarm Acknowledge - alarm type and number, device number, date/time of acknowledgement
- NVMEM Switched - time/date condition detected
- MT Comm Card Removed - time/date condition detected

PC Interface Software Options

INFORM

Inform™ is a Microsoft® Windows®-based software package for managing inventory and compliance information on Veeder-Root TLS 3XX Consoles from any location. It provides you with direct or remote polling access to all inventory, alarm, and leak detection information. It can also remotely configure consoles and inventory information.

Alarm Message Quick Reference Index

Alarm messages that appear on the console's front panel display are listed alphabetically in this index. Each alarm is preceded by a device code (explained in the insert to the left of the table below). Multiple device codes mean that more than one alarm can post this same message.

Table 1-1.- System Device Code

Device	Description
C	2-wire CL sensor (type A)
D	Receiver (phone, fax, etc.)
E	Dispenser interface module - Electronic
G	Groundwater sensor
H	3-wire CL sensor (type B)
I	External input device
L	Liquid sensor
M	Dispenser interface module - Mechanical
P	VLLD
Q	PLLD
R	Output relay

Table 1-1.- System Device Code

Device	Description
r	Pump Relay Monitor
S	Pump sensor
s	Smart Sensor
T	In-tank probe
V	Vapor sensor
W	WPLLD
X	VMCI interface module
x	VMC (vapor monitoring controller)

Use this index to go quickly to the help tables for causes and a recommended corrective action.

Table 1-2.- Alarm Message Quick Reference Index

Device Code	Alarm Message	See Table and Page
D	ALARM CLEAR WARNING	Table 29-10 on page 29-9
P	ANN-LINE SELF FAIL	Table 29-13 on page 29-12
P	ANN-LINE TEST FAIL	Table 29-13 on page 29-12
P	ANN-PUMP SELF FAIL	Table 29-13 on page 29-12
P	ANN-PUMP TEST FAIL	Table 29-13 on page 29-12
P,Q,T,W	ANN TST NEEDED ALM	P = Table 29-13 on page 29-12 Q = Table 29-11 on page 29-9 T = Table 29-3 on page 29-4 W = Table 29-12 on page 29-11
P,Q,T,W	ANN TST NEEDED WRN	P = Table 29-13 on page 29-12 Q = Table 29-11 on page 29-9 T = Table 29-3 on page 29-4 W = Table 29-12 on page 29-11
Q,W	ANNUAL LINE FAIL	Table 29-11 on page 29-9 W = Table 29-12 on page 29-11
T	ANNUAL TEST FAIL	Table 29-3 on page 29-4
D	AUTODIAL FAILURE	Table 29-10 on page 29-9
	BATTERY IS OFF	Table 29-2 on page 29-3
E	TRANSACTION ALARM	Table 29-19 on page 29-16
	CLOCK IS INCORRECT	Table 29-2 on page 29-3
	CLOSE DAILY WARNING	Table 29-19 on page 29-16

Table 1-2.- Alarm Message Quick Reference Index (Continued)

Device Code	Alarm Message	See Table and Page
	CLOSE SHIFT WARNING	Table 29-19 on page 29-16
E, M, s	COMMUNICATION ALARM	E, M = Table 29-19 on page 29-16 s = Table 29-20 on page 29-17
P, Q, W	CONT HANDLE ALRM	P=Table 29-13 on page 29-12 Q=Table 29-11 on page 29-9 W=Table 29-12 on page 29-11
T	CSLD INCNR RATE WARN	Table 29-3 on page 29-4
T	DELIVERY NEEDED	Table 29-3 on page 29-4
T	DELIVY DENSITY WRN	Table 29-3 on page 29-4
E, M	DISABLED DIM ALARM	Table 29-19 on page 29-16
X	DISABLED VMCI ALARM	X = Table 29-22 on page 29-18
I	EXTERN INPUT ALARM	Table 29-18 on page 29-16
x	FP SHUTDOWN WRN	Table 29-23 on page 29-18
x	FP SHUTDOWN ALM	Table 29-23 on page 29-18
	FEPROM WRITE FAILURE	Table 29-2 on page 29-3
L, V, G, C, H, s	FUEL ALARM	L=Table 29-5 on page 29-6 & Table 29-6 on page 29-7 V=Table 29-9 on page 29-8 G=Table 29-14 on page 29-14 C=Table 29-15 on page 29-14 & Table 29-16 on page 29-15 H=Table 29-17 on page 29-15 s = Table 29-20 on page 29-17
P,Q,W	FUEL OUT	P=Table 29-13 on page 29-12 Q=Table 29-11 on page 29-9 W=Table 29-12 on page 29-11
T	FUEL QUALITY ALARM	Table 29-3 on page 29-4
s	FUEL WARNING	Table 29-20 on page 29-17
T	GROSS FAIL LINE TNK	Table 29-3 on page 29-4
Q,W	GROSS LINE FAIL	Q=Table 29-11 on page 29-9 W=Table 29-12 on page 29-11
T	GROSS TEST FAIL	Table 29-3 on page 29-4
P	GRS LINE SELF FAIL	Table 29-13 on page 29-12
P	GRS LINE TEST FAIL	Table 29-13 on page 29-12
P	GRS PUMP SELF FAIL	Table 29-13 on page 29-12
P	GRS PUMP TEST FAIL	Table 29-13 on page 29-12

Table 1-2.- Alarm Message Quick Reference Index (Continued)

Device Code	Alarm Message	See Table and Page
L, H, s	HIGH LIQUID ALARM	L=Table 29-8 on page 29-7 & Table 29-7 on page 29-7 H=Table 29-17 on page 29-15 s = Table 29-20 on page 29-17
s	HIGH LIQUID WARNING	Table 29-20 on page 29-17
T	HIGH PRODUCT ALARM	Table 29-3 on page 29-4
T	HIGH WATER ALARM	Table 29-3 on page 29-4
T	HIGH WATER WARNING	Table 29-3 on page 29-4
s	INSTALL ALARM	Table 29-20 on page 29-17
T	INVALID FUEL LEVEL	Table 29-3 on page 29-4
T	LEAK ALARM	Table 29-3 on page 29-4
P	LINE LEAK SHUTDOWN	Table 29-13 on page 29-12
P	LINE LEAK TEST FAIL	Table 29-13 on page 29-12
L, H	LIQUID WARNING	L=Table 29-8 on page 29-7 H=Table 29-17 on page 29-15
P	LLD PRESSURE ALARM	Table 29-13 on page 29-12
P	LLD PRESSURE WARN	Table 29-13 on page 29-12
P	LLD SELF TEST FAIL	Table 29-13 on page 29-12
P	LLD TEST FAULT-ANN	Table 29-13 on page 29-12
P	LLD TEST FAULT-GRS	Table 29-13 on page 29-12
P	LLD TEST FAULT-PER	Table 29-13 on page 29-12
Q,W	LN EQ FAULT ALM	Q=Table 29-11 on page 29-9 W=Table 29-12 on page 29-11
L, s	LOW LIQUID ALARM	L = Table 29-7 on page 29-7 s = Table 29-20 on page 29-17
s	LOW LIQUID WARNING	Table 29-20 on page 29-17
Q	LOW PRESSURE ALARM	Table 29-11 on page 29-9
T	LOW PRODUCT ALARM	Table 29-3 on page 29-4
T	LOW TEMP WARNING	Table 29-3 on page 29-4
T	MAX PRODUCT ALARM	Table 29-3 on page 29-4
x	METR NC ALM	Table 29-23 on page 29-18
T	MISSING TICKET WARN	Table 29-3 on page 29-4
D	NO DIAL TONE ALARM	Table 29-10 on page 29-9
T	NO CSLD IDLE TIME	Table 29-3 on page 29-4

Table 1-2.- Alarm Message Quick Reference Index (Continued)

Device Code	Alarm Message	See Table and Page
	NO MT COMM	Table 29-2 on page 29-3
	NO NVMEM	Table 29-2 on page 29-3
s	NO VACUUM ALARM	Table 29-20 on page 29-17
T	OVERFILL ALARM	Table 29-3 on page 29-4
	PAPER OUT	Table 29-2 on page 29-3
	PC (H8) REVISION WARN	Table 29-2 on page 29-3
P	PER-LINE SELF FAIL	Table 29-13 on page 29-12
P	PER-LINE TEST FAIL	Table 29-13 on page 29-12
P	PER-PUMP SELF FAIL	Table 29-13 on page 29-12
P	PER-PUMP TEST FAIL	Table 29-13 on page 29-12
P,Q,T,W	PER TST NEEDED ALM	P = Table 29-13 on page 29-12 Q = Table 29-11 on page 29-9 T = Table 29-3 on page 29-4 W = Table 29-12 on page 29-11
P,Q,T,W	PER TST NEEDED WRN	P = Table 29-13 on page 29-12 Q = Table 29-11 on page 29-9 T = Table 29-3 on page 29-4 W = Table 29-12 on page 29-11
Q, W	PERIOD LINE FAIL	Q = Table 29-11 on page 29-9 W= Table 29-12 on page 29-11
T	PERIODIC TEST FAIL	T= Table 29-3 on page 29-4
Q	PLLD OPEN ALARM	Table 29-11 on page 29-9
Q	PLLD SHUTDOWN ALARM	Table 29-11 on page 29-9
	PRINTER ERROR	Table 29-2 on page 29-3
T	PROBE OUT	Table 29-3 on page 29-4
	PROD THRESHOLD ALM	Table 29-19 on page 29-16
	PROTECTIVE COVER ALM	Table 29-2 on page 29-3
r	PUMP RELAY ALARM	Table 29-21 on page 29-18
	RAM ERR ADDR = 01E80000 RAM ERR DATA = XXXXXXXX	Table 29-2 on page 29-3
s	RELAY ACTIVE	Table 29-20 on page 29-17
	REMOTE DISPLAY ERROR	Table 29-2 on page 29-3
	ROM REVISION WARNING	Table 29-2 on page 29-3
P	SELF TEST INVALID	Table 29-13 on page 29-12

Table 1-2.- Alarm Message Quick Reference Index (Continued)

Device Code	Alarm Message	See Table and Page
s	SENSOR FAULT ALARM	Table 29-20 on page 29-17
	SENSOR FAULT WARNING	
L, V, C, H	SENSOR OUT ALARM	L=Table 29-7 on page 29-7 V=Table 29-9 on page 29-8 C=Table 29-15 on page 29-14 & Table 29-16 on page 29-15 H=Table 29-17 on page 29-15
	SERVICE SESSION ENABLED	Table 29-2 on page 29-3
D	SERVICE REPORT WARN	Table 29-10 on page 29-9
C, D, H, L, P, Q, r, s, T, V, W, X	SETUP DATA WARNING	C=Table 29-15 on page 29-14 & Table 29-16 on page 29-15 D =Table 29-10 on page 29-9 H=Table 29-17 on page 29-15 L=Table 29-7 on page 29-7 P = Table 29-13 on page 29-12 Q = Table 29-11 on page 29-9 r = Table 29-21 on page 29-18 s = Table 29-20 on page 29-17 T = Table 29-3 on page 29-4 V=Table 29-9 on page 29-8 W = Table 29-12 on page 29-11 X = Table 29-22 on page 29-18
L, V, G, C, H	SHORT ALARM	L=Table 29-7 on page 29-7 V=Table 29-9 on page 29-8 G=Table 29-14 on page 29-14 C=Table 29-15 on page 29-14 & Table 29-16 on page 29-15 H=Table 29-17 on page 29-15
	SOFTWARE MODULE WARN	Table 29-2 on page 29-3
	SYS MAINT NVMEM ERR	
	SYS MT SER CARD ERR	
T	SUDDEN LOSS ALARM	Table 29-3 on page 29-4
	SYSTEM SELF-TEST ALM	Table 29-2 on page 29-3
T	TANK SIPHON BREAK	Table 29-3 on page 29-4
T	TANK TEST ACTIVE	Table 29-3 on page 29-4
	TANK TEST SHUTDOWN	Table 29-2 on page 29-3
s	TEMPERATURE WARNING	Table 29-20 on page 29-17
	TOO MANY TANKS	Table 29-2 on page 29-3
s	VACUUM WARNING	Table 29-20 on page 29-17

Table 1-2.- Alarm Message Quick Reference Index (Continued)

Device Code	Alarm Message	See Table and Page
V, C, s	WATER ALARM	V=Table 29-9 on page 29-8 C=Table 29-15 on page 29-14 & Table 29-16 on page 29-15 s = Table 29-20 on page 29-17
G	WATER OUT ALARM	G=Table 29-14 on page 29-14
s	WATER WARNING	Table 29-20 on page 29-17
x	VMC COM TIMEOUT	Table 29-23 on page 29-18
W	WPLLD COMM ALARM	Table 29-12 on page 29-11
W	WPLLD OPEN WARN	Table 29-12 on page 29-11
W	WPLLD SHUTDOWN ALARM	Table 29-12 on page 29-11

2 Basic Operation

The Operating Mode lets you view inventory information, check in-tank and line leak test status and results, manually start and stop in-tank and line leak tests, print reports and test output relays. In Operating Mode, the top level display shows the current date and time and, if there are no alarms, the system status message "ALL FUNCTIONS NORMAL".

OPERATING MODE FUNCTIONS

IMPORTANT! The list below contains all of the available Operating Mode Functions.



NOTE: only the Functions/Steps relevant to your console and its installed options and connected detection systems will be accessible.

- In-Tank Inventory Data
- Tanker Load Report
- Last-Shift Inventory
- CSLD Test Results
- Start Line Pressure Test (PLLD)
- WPLLD Line Leak Results
- Stop WPLLD Line Test
- Line Leak Detect (VLLD) Results
- Stop Line Leak Test (VLLD)
- Liquid Status
- Groundwater Status
- 3-Wire CL (type B) Status
- Stop In-Tank Leak Test
- Smart Sensor Status
- Start Mag Sump Sensor Leak Test
- Maintenance Tracker
- Delivery Maintenance
- Fuel Manager
- In-Tank Test Results
- Pressure Line Results
- Stop Pressure Test (PLLD)
- Start WPLLD Line Test
- WPLLD Line Results
- Start Line Leak Test (VLLD)
- Pump Relay Monitor Status
- Vapor Status
- 2-Wire CL (type A) Status
- Start In-Tank Leak Test
- Test Output Relays
- Mag Sump Sensor Leak Test Results
- Maintenance Report
- VMC Report

STEPS

Within each Function are Steps at which particular types of information are accessed or procedures carried out.

OPERATING MODE FUNCTIONS

The table below lists all of the possible Operating Mode Functions and Steps accessible from the front panel key pads. In the table, key presses are denoted by ↓ in front of the appropriate front panel key.

2 Basic Operation

Operating Mode Functions (1 of 4)

↓FUNCTION **IN-TANK INVENTORY** (↓PRINT - Inventory for all tanks)

- ↓STEP VOLUME
- ↓STEP HEIGHT
- ↓STEP WATER VOL
- ↓STEP WATER
- ↓STEP TEMPERATURE
- ↓STEP ULLAGE
- ↓STEP TC VOLUME
- ↓STEP DENSITY
- ↓STEP MASS
- ↓STEP DELIVERY
- ↓STEP NEXT DELIVER DENSITY
- ↓STEP LAST DELIVERY DENSITY

↓FUNCTION **DELIVERY MAINTENANCE** (↓PRINT - Deliveries to all tanks)

- ↓STEP EDIT/VIEW (↓TANK - View delivery by tank)
- ↓STEP TICKET VOLUME
- ↓STEP BOL (↓PRINT - Deliveries to tank)
- ↓STEP PRIOR DLVY FOR TANK (↓TANK - Return to Edit/View)
- ↓STEP INSERT
- ↓STEP INSERT DLVY BY TANK
- ↓STEP ENTER DLVY DATE
- ↓STEP ENTER DLVY TIME
- ↓STEP ENTER TICKET VOLUME
- ↓STEP BOL
- ↓STEP (Insert more deliveries for other tanks)

↓FUNCTION **TANKER LOAD REPORT** (↓PRINT - Last 40 load reports for all tanks since 12:00 AM)

- ↓STEP SINGLE TANK (↓PRINT - Last 40 load reports for selected tank since 12:00 AM)
- ↓STEP SINGLE TANK AND LOAD NO. (↓PRINT - Last load report for selected tank)

↓FUNCTION **FUEL MANAGEMENT**

- ↓STEP PRINT SHORT REPORT (↓PRINT - Short report for all tanks)
- ↓STEP DAYS FUEL REMAINING (↓PRINT - Fuel Management report for selected tank)
- ↓STEP INVENTORY
- ↓STEP 95% ULLAGE
- ↓STEP AVG. DAILY SALES SUN. - SAT.

↓FUNCTION **LAST SHIFT INVENTORY** (↓PRINT - All shift data for all tanks)

- ↓STEP BEGINNING INVENTORY (↓PRINT - All shift data for selected tank)
 - ↓STEP ENDING INVENTORY
 - ↓STEP ADJUSTMENT DELIVERY
 - ↓STEP GROSS CHANGE
 - ↓STEP GROSS CURRENT SHIFT NOW (No/Yes)
-

2 Basic Operation

Operating Mode Functions (2 of 4)

↓FUNCTION	IN-TANK TEST RESULTS (↓PRINT - Results for all tanks)
↓STEP	GROSS (Passed/Failed/Invalid) (↓PRINT - Results for selected tank)
↓STEP	PERIODIC (Passed/Failed/Invalid)
↓STEP	ANNUAL (Passed/Failed/Invalid)

↓FUNCTION	CSLD TEST RESULTS
↓STEP	CLSD CURRENT TST RESULTS
↓STEP	CLSD FULLEST LAST PASS

↓FUNCTION	PRESSURE LINE LEAK RESULTS (↓PRINT - Results for all lines)
↓STEP	3.0 gph (11.3 lph) TEST (Passed/Failed/No Data Avail) (↓PRINT - Results for line)
↓STEP	0.2 gph (0.76 lph) TEST (Passed/Failed/No Data Avail)
↓STEP	0.1 gph (0.38 lph) TEST (Passed/Failed/No Data Avail)
↓STEP	↓PRINT - History Reports

↓FUNCTION	START LINE PRESSURE TEST (PLLD)
↓STEP	SELECT LINE (All Lines/Single Line #)
↓STEP	SELECT TEST TYPE (3.0 gph [11.3 lph] / 0.2 gph [0.76 lph] / 0.1 gph [0.38 lph])
↓STEP	START LINE TEST

↓FUNCTION	STOP PRESSURE TEST (PLLD)
↓STEP	SELECT LINE (All Lines/Single Line #)
↓STEP	STOP LINE TEST

↓FUNCTION	WPLLD LINE LEAK RESULTS (↓PRINT - Results for all lines)
↓STEP	3.0 gph (11.3 lph) TEST (Passed/Failed/No Data Avail) (↓PRINT - Results for line)
↓STEP	0.2 gph (0.76 lph) TEST (Passed/Failed/No Data Avail)
↓STEP	0.1 gph (0.38 lph) TEST (Passed/Failed/No Data Avail)
↓STEP	↓PRINT - History Reports

↓FUNCTION	START WPLLD LINE TEST
↓STEP	SELECT LINE (All Lines/Single Line #)
↓STEP	SELECT TEST TYPE (3.0 gph [11.3 lph] / 0.2 gph [0.76 lph] / 0.1 gph [0.38 lph])
↓STEP	START LINE TEST

↓FUNCTION	STOP WPLLD LINE TEST
↓STEP	SELECT LINE (All Lines/Single Line #)
↓STEP	STOP LINE TEST

2 Basic Operation

Operating Mode Functions (3 of 4)

↓FUNCTION	LINE LEAK DETECT (VLLD) RESULTS (↓PRINT - Results for all lines)
↓STEP	0.2 gph (0.76 lph) TEST (Passed/Failed/No Data Avail) (↓PRINT - Results for line)
↓STEP	0.1 gph (0.38 lph) TEST (Passed/Failed/No Data Avail)

↓FUNCTION	START LINE LEAK TEST (VLLD)
↓STEP	TEST METHOD (All Lines/Single Line)
↓STEP	TEST RATE (0.2 gph [0.76 lph] / 0.1 gph [0.38 lph] / Air Purge Procedure)
↓STEP	START TEST (No/Yes)

↓FUNCTION	STOP LINE LEAK TEST (VLLD)
↓STEP	STOP METHOD (All Lines/Single Line)
↓STEP	STOP LINE LEAK TEST (No/Yes)

↓FUNCTION	PUMP RELAY MONITOR STATUS (↓PRINT - Status for all relays)
↓STEP	RELAY STATUS

↓FUNCTION	LIQUID STATUS (↓PRINT - Status for all sensors)
↓STEP	SENSOR STATUS

↓FUNCTION	VAPOR STATUS (↓PRINT - Status for all sensors)
↓STEP	SENSOR STATUS

↓FUNCTION	GROUNDWATER STATUS (↓PRINT - Status for all sensors)
↓STEP	SENSOR STATUS

↓FUNCTION	2-WIRE C.L. (TYPE A) STATUS (↓PRINT - Status for all sensors)
↓STEP	SENSOR STATUS

↓FUNCTION	3-WIRE C.L. (TYPE B) STATUS (↓PRINT - Status for all sensors)
↓STEP	SENSOR STATUS

↓FUNCTION	START IN-TANK LEAK TEST
↓STEP	TEST (All tanks/Single tank)
↓STEP	TEST (All [Timed duration/Manual stop]) / Single (Tank # [↓TANK]/Timed duration/Manual stop)
↓STEP	SELECT RATE (0.2 gph [0.76] / 0.1 gph [0.38 lph])
↓STEP	TEST DURATION (Enter time in hours)
↓STEP	START LEAK TEST

↓FUNCTION	STOP LINE LEAK TEST (VLLD)
↓STEP	STOP (All tanks/Single tank)
↓STEP	STOP LEAK TEST

2 Basic Operation

Operating Mode Functions (4 of 4)

↓FUNCTION	TEST OUTPUT RELAYS
↓STEP	ENTER RELAY NUMBER
↓ALARM/TEST	Display reads: Relay X On/Off. Press any key to printout Relay Setup
↓STEP	ENTER RELAY NUMBER (repeat above steps for each relay)

↓FUNCTION	MAG SUMP LEAK TEST RESULTS
↓STEP	View last passed test of sensor (↓PRINT - Status for sensor)

↓FUNCTION	MAG SUMP LEAK TEST
↓STEP	SELECT SENSOR (All Sensors / Single Sensor)
↓STEP	START MAG SUMP LEAK TEST (All Sensors / Single Sensor)
↓STEP	START MEASURING HEIGHT (All Sensors / Single Sensor)
↓STEP	STOP MAG SUMP LEAK TEST (All Sensors / Single Sensor)

↓FUNCTION	SMART SENSOR STATUS (↓PRINT - Status for all sensors)
↓STEP	SS STATUS

↓FUNCTION	VMC REPORT (↓PRINT - Status for all VMC controllers)
↓STEP	To view status of x1 VMC or press TANK/SENSOR to select xn VMC
↓ENTER	STATUS (Side A)
↓STEP	RECOVER RATE (Side A)
↓STEP	FUEL COUNTER (Side A)
↓STEP	ERROR COUNTER (Side A)
↓STEP	REMAIN TIME (Side A)
↓STEP	STATUS (Side B)
↓STEP	RECOVER RATE (Side B)
↓STEP	FUEL COUNTER (Side B)
↓STEP	ERROR COUNTER (Side B)
↓STEP	REMAIN TIME (Side B)

SETUP MODE

The system is programmed to operate according to the monitoring requirements of your site using the Setup Mode. It is unlikely that changes to the setup will be required during normal operating conditions. Only qualified personnel, following the instructions in the *System Setup Manual*, should revise system setup.

RECONCILIATION MODE (TLS-350R ONLY)

The TLS-350R automatically gathers information on meter readings, deliveries, and daily inventory measurements. It reconciles the totals at the end of each shift, day, and period. This eliminates the need to manually collect and reconcile the fuel inventory. In the Reconciliation Mode, you can view this data and print reconciliation and adjusted delivery reports. By reviewing these reports, you can recognize sudden losses and short bulk deliveries.

DIAGNOSTIC MODE

Alarm History reports and Leak Test Results reports (if your system is equipped to conduct in-tank leak tests) are accessible in the Diagnostic Mode. Fuel Management reports (Fuel Management option) are accessible in both the Operator and Diagnostic Modes. Additional functions of this mode, such as the Service Report feature and system diagnostics, are used primarily by trained service personnel.

3 Front Panel Keypads

Description

There are two 12-key sets; one with Operating Keys and one with Alphanumeric Keys (see Figure 3-1).

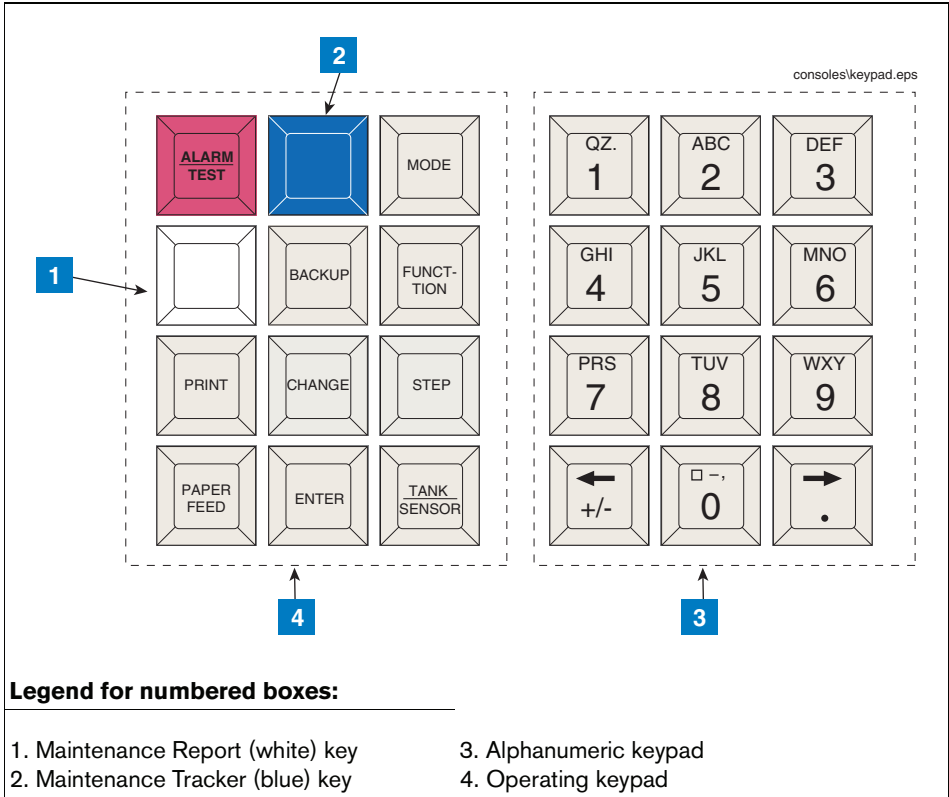

Figure 3-1. Console keypad

OPERATING KEYPAD

Operating Keys let you display and print information, start and stop tests, program the system, test system operation and review diagnostics.

ALPHANUMERIC KEYPAD

Alphanumeric keys have alphanumeric and cursor movement functions for entering setup information.

Operating Key Functions

ALARM/TEST

ALARM/TEST silences the alarm. It does not clear the alarm message from the display or disable the alarm. This key also activates and deactivates output relays when using the Output Relay Test function. If your system has a printer, it will print an alarm or warning report when this button is pressed.

MODE

MODE selects a mode: Operating, Setup, Reconciliation (TLS-350R only), or Diagnostic. If you press MODE while in a Function or Step, the system advances to the next mode.

FUNCTION

FUNCTION accesses functions within a mode. If you press FUNCTION while in a Step, the system advances to the next function.

STEP

STEP moves from one procedure to the next within a Function.

TANK/SENSOR

TANK/SENSOR advances by tank or sensor through setup procedures or diagnostic data.

CHANGE

CHANGE is used in Operating and Setup Modes to enter and revise a previous setup parameter or change an entry.

ENTER

ENTER either completes a selection or enters data into a function.

BACKUP

BACKUP lets you move backward through Steps, Functions and Modes to access data or entries you have already passed.

PRINT

PRINT generates reports.

BLUE KEY (MAINTENANCE TRACKER - TLS-350 ONLY)

Contractor connects a valid ID Key to the TLS and presses the blue key to log in for a work session. Note: This key is available in consoles with Version 27 and higher software. In addition to certain hardware requirements, the Maintenance Tracker feature must be enabled for this key to function.

WHITE KEY (MAINTENANCE REPORT - TLS-350 ONLY)

Press the white key to printout up to the last 75 maintenance history records. Additional records going back up to 3 years are also selectable. Note: This key is available in consoles with Version 27 and higher software and is functional only if the Maintenance History or Maintenance Tracker feature enabled.

Alphanumeric Entries

Keys 0 through 9 are both alphabetic and numeric. You select each character on the key with successive presses of the key. For example:

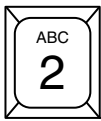

To enter either an alphabetic or numeric character, press the 2 key once to enter an "A". Press the key again to change the character to a "B", again to enter a "C", and again to enter a "2".

When the correct character appears, and the next character is on the same key, press the  right-arrow key to move the cursor to the next position and enter the next character. (If the next character is on another key, you can press the new key instead of the right-arrow key.) When you have entered all the characters, press ENTER.

If you enter an incorrect character, use the arrow keys to move the cursor to the incorrect character, press CHANGE and enter the correct character.

The period (.) is on key "1".



The Zero key has a comma (,) plus two special characters for alphanumeric entries. They are:

- = Space (no character)
- = Hyphen

Cursor Keys

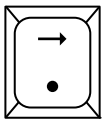

The Right-Arrow advances the cursor to the right when making alphanumeric entries and selecting certain parameters such as module configurations during system setup.

The • (decimal) is used in numeric entries.

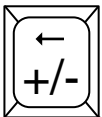

The Left-Arrow key moves the cursor to the left.

The +/- is used to enter positive or negative Tank Tilt value during system setup.

4 In-Tank Inventory

In-Tank Inventory lets you view and print information about how much product you have in your tanks. To select In-Tank Inventory, press FUNCTION until you see the message:

```
IN-TANK INVENTORY  
PRESS <STEP> TO CONTINUE
```

Press STEP to view the tank inventory for your first tank:

```
T 1: (PRODUCT NAME)  
VOLUME = XXXXX (UNITS)
```

The system displays the fuel volume (how much of the product is in the tank) in gallons or liters. For example, if you had unleaded gasoline in Tank 1 containing 10,000 gallons of fuel, the system would display the message:

```
T 1: UNLEADED  
VOLUME = 10,000 GAL
```

To view how much inventory is in the next tank, press TANK. The system will display the data for Tank 2. To view the inventory for Tank 3, press TANK again. You can view the inventory for up to eight tanks.

Printing In-Tank Inventory

To print an Inventory Report for all tanks in a system, press PRINT while the monitor is displaying the status message:

```
MMM DD, YYYY HH:MM XM  
ALL FUNCTIONS NORMAL
```

You can also print an Inventory Report when you are viewing tank inventory information:

```
T 1: (PRODUCT NAME)  
VOLUME = XXXXX (UNITS)
```

When you press PRINT, the system begins printing the report. An example inventory report is shown below. You can print a report for up to eight tanks.

```

MMM DD, YYYY HH:MM XM

INVENTORY REPORT
-----
T 1: (product label)
T2: REG UNLEADED TANK 2
VOLUME      =      2549 GALS
ULLAGE      =      7151 GALS
90% ULLAGE  =      6181 GALS
TC VOLUME   =      2525 GALS
MASS        =      15290 LBS
DENSITY     =  5.9987 LBS/GAL
HEIGHT      =      29.02 INCHES
WATER VOL   =           0 GALS
WATER       =           0.00 INCHES
TEMP        =           74.4 DEG F

T 2: (product label)
      :
      :

```

← 90% or 95% depending on percent selected in System Setup
 ← Only appears if Mass/Density feature enabled

Fuel Height

Fuel height is the depth of all liquid in the tank in inches or millimeters. To view the liquid height in the tank, press STEP repeatedly until this message appears:

```

T1: (PRODUCT NAME)
HEIGHT = XX.XX (UNITS)

```

For example, if you had 80 inches of liquid in Tank 1, the system would display the message:

```

T1: UNLEADED
HEIGHT = 80.00 INCHES

```

Press TANK again to view the liquid height for the next tank. You can view information for up to eight tanks.

Water Volume

Water volume is the amount of water in the tank in gallons or liters. To view the Water Volume in a tank, press STEP until you see the message:

```

T 1: (PRODUCT NAME)
WATER VOL = XXXXX (UNITS)

```

For example, if Tank 1 containing regular gasoline had a water volume of 1 gallon, the system would display the message:

```

T 1: REGULAR
WATER VOL = 1 GALS

```

Note: If you are using high alcohol probes, Water Volume will not appear on the display or the printed reports.

Water Height

Water Height is the depth of the water in the tank. To view the Water Height, press STEP until you see the message:

```
T 1: (PRODUCT NAME)
WATER = X.XX (UNITS)
```

For example, if Tank 1 containing regular gasoline had a water height of 2 inches, the system would display the message:

```
T 1: REGULAR
WATER = 2.00 INCHES
```

Note: If you are using high alcohol probes that cannot detect water, Water Height will not appear on the display or the printed reports.

Fuel Temperature

The console displays the fuel temperature in the tank in Fahrenheit (F) or Centigrade (C) temperature, depending on how your system was set up. To find out what the fuel temperature in Tank 1 is, press STEP until you display the message:

```
T1: (PRODUCT NAME)
TEMP = XX.X DEG (F or C)
```

For example, if the fuel in Tank 1 is Premium Unleaded and the temperature is 65 degrees Fahrenheit, the system would display the message:

```
T1: PREMIUM UNLEADED
TEMP = 65.0 DEG F
```

To view the temperature for other tanks, press TANK. To print an inventory report for all tanks, press PRINT.

Ullage

Ullage is the amount of room left in the tank. Normally, a tank is not totally full to leave room for the product to expand. To determine tank ullage, press STEP until you see the message:

```
T1: (PRODUCT NAME)
ULLAGE = XXXXX (UNITS)
```

For example, if the system displays the message:

```
T1: REGULAR UNLEADED
ULLAGE = 5792 GALS
```

you would have to add 5,792 gallons of product to fill the tank to capacity. Press TANK to view ullage for other tanks in the system. To print an inventory report for all tanks, press PRINT.

Temperature Compensated Volume

To view the Temperature Compensated Volume, press STEP until you see the message:

```
T 1: (PRODUCT NAME)
TC VOLUME = XXXXX (UNITS)
```

To print an inventory report for all tanks, press PRINT.

Note: If Temperature Compensated Volume was set to "Disable" using the System Setup function, you will not be able to print the Temperature Compensated Volume on the report.

Delivery Increase Amount

To view the inventory increase for a tank (the last delivery amount), press STEP until you see the message:

```
T 1: (PRODUCT NAME)
DELIVERY = XXXXX (UNITS)
```

To view the last delivery amount for other tanks in the system, press TANK. To print an inventory increase report for the selected tank, press PRINT. The Delivery Report shows how much the inventory has increased. For example:

```
MMM DD, YYYY HH:MM XM

T1: REGULAR UNLEAD
INVENTORY INCREASE

INCREASE START
MMM DD, YYYY HH:MM XM

VOLUME          =      5146 GALS
HEIGHT          =       44 INCHES
WATER           =       0.00 INCHES
TEMP            =      46.8 DEG F

INCREASE END
MMM DD, YYYY HH:MM XM

VOLUME          =      8104 GALS
HEIGHT          =       84 INCHES
WATER           =       0.00 INCHES
TEMP            =      47.2 DEG F

GROSS INCREASE  =          2958
TC NET INCREASE =          2983
```

Note: If you are using high alcohol probes, Water Height will not appear on the display or the printed reports.

Density (Optional Feature)

If Mass/Density (ref. System Setup) is disabled, none of the windows below will appear.

To view the density of the product in the tank, press STEP until you see the message:

```
T 1: (PRODUCT NAME)
DENSITY = X.XXXX LBS/GAL
```

— This value is the density entered in In-Tank Setup until a delivery density is entered. Thereafter it is the density recalculated by the console following each delivery density entry.

Press STEP to view the mass (derived from density) of the product in the tank (mass is in units selected in System Setup):

```
T 1: (product label)
MASS = 31583 LBS
```

To view the Next Delivery's entered density, press STEP until you see:

```
T 1: NEXT DELIVERY
DENSITY = X.XXXX
```

— This is the density entered for the next delivery. This value will default to 0 after the delivery report is printed.

To view the Last Delivery's entered density, press STEP until you see:

```
T 1: LAST DELIVERY
DENSITY = X.XXXX
```

— This is the density entered in the Next delivery display prior to the printing of the delivery report for that delivery. If 0, then a density was not entered for the last delivery (the system actually uses the current tank density for a delivery when one is not entered). NOTE: this display is not shown if a delivery has not occurred.

TO ENTER A DELIVERED PRODUCT'S DENSITY

You can enter the density of a delivery as follows:

- In the Next Delivery display prior to, or during, the delivery before the console prints out the delivery report, or
- In the Last Delivery display any time after the console prints the completed delivery report up until the next delivery completes.

Press STEP until you see the Next Delivery display (to enter density of an in-progress or upcoming delivery) or Last Delivery display (to enter density of the last completed delivery). Press CHANGE and enter any one of the three values below from the product's delivery ticket (units are not entered):

- Mass per unit volume at reference temperature (actual),
- Specific Gravity, or
- API number

```
T 1: XXXX DELIVERY
DENSITY :5.9972
```

where XXXX = NEXT or LAST

Press ENTER and the console converts the entered value to the actual density:

```
DENSITY :5.9972
PRESS <STEP> TO CONTINUE
```

Tank density will be recalculated to account for the delivery.

5 Delivery Maintenance

Delivery Maintenance lets you edit, insert, view, and print information about ticketed deliveries. Using this function, you manually enter ticketed volumes and Bill of Lading (BOL) delivery information for the tanks in your system. You can then compare the ticketed volumes to the gauged volumes reported by your console (refer to Reconciliation Mode on page 28-1 for more information). Before you use this function, Ticketed Delivery must be enabled in the Setup Mode.

To select Delivery Maintenance, press FUNCTION until you see the message:

```
DELIVERY MAINTENANCE
PRESS <STEP> TO CONTINUE
```

Editing Ticketed Deliveries

To enter the volume for a ticketed delivery, press STEP to go to the Edit/View or Insert message:

```
EDIT/VIEW OR INSERT
SELECT: EDIT/VIEW
```

Press STEP:

```
SELECT: EDIT/VIEW
T 1: UNLEADED GASOLINE
```

To select other tanks in the system, press TANK/SENSOR. Press STEP to view the last delivery for this tank:

```
T 1: XXX XX, XXXX XX:XXXX
TICKET VOLUME: XXX
```

To view the previous delivery, press STEP. To change the volume for this delivery, press CHANGE, the volume and then ENTER. In the example below, 450 was entered:

```
T 1: XXX XX, XXXX XX:XXXX
TICKET VOLUME: 450
```

Press STEP:

```
TICKET VOLUME: 450
PRESS <STEP> TO CONTINUE
```

Press STEP:

```
T 1: XXX XX, XXXX XX:XXXX
BOL:
```

To enter a Bill of Lading number for this delivery, e.g. 23223, press CHANGE, the number, and then ENTER:

```
T 1: XXX XX, XXXX XX:XXXX
BOL: 23223
```

Press STEP:

```
BOL: 23223
PRESS <STEP> TO CONTINUE
```

Press STEP to view the previous delivery for this tank:

```
T 1: XXX XX, XXXX XX:XXXX
TICKET VOLUME: XXX
```

Inserting Ticketed Deliveries

If your console is down for maintenance when a delivery occurs and you need to enter a delivery manually, press STEP to go to the Edit/View or Insert message:

```
EDIT/VIEW OR INSERT
SELECT: EDIT/VIEW
```

Press CHANGE to choose INSERT, then press ENTER for your change to be accepted. The system displays this message:

```
SELECT: INSERT
PRESS <STEP> TO CONTINUE
```

Press STEP to verify that you want to insert ticketed deliveries. The system displays this message:

```
SELECT: INSERT
T 1: UNLEADED GASOLINE
```

To select other tanks in the system, press TANK/SENSOR. Press STEP to see the message below. The date that appears is the current date.

```
ENTER DELIVERY DATE
DATE: XX/XX/XXXX
```

Press STEP to continue or press CHANGE, ENTER, and STEP to change the date that appears in the display. If you enter a date that is out of the range of the current or previous reconciliation periods, the error message, "DATE IS OUT OF RANGE," will appear. This message appears if you enter a valid date:

```
ENTER DELIVERY TIME
TIME: XX:XX XX
```

The time that appears is the current time. Press STEP to continue or press CHANGE, ENTER, and STEP to change the time that appears in the display. Select AM or PM. If you enter the same date and time as another existing ticketed delivery, you will see an "INVALID INSERT" error. This message appears if you enter a valid time:

```
T 1: XXX XX, XXXX XX:XXXX
TICKET VOLUME: 0
```

To enter a volume, e.g., 2500, press CHANGE and ENTER:

```
T 1: XXX XX, XXXX XX:XXXX
TICKET VOLUME: 2500
```

To enter a Bill of Lading number press STEP until you see the message:

```
T 1: XXX XX, XXXX XX:XXXX
BOL:
```

To enter a Bill of Lading number for this delivery, e.g. EXX23223, press CHANGE, the number and then ENTER:

```
T 1: XXX XX, XXXX XX:XXXX
BOL: EXX23223
```

Press STEP:

```
BOL: EXX23223
PRESS <STEP> TO CONTINUE
```

Printing Delivery Reports

Delivery Reports show the delivery time, ticketed volume, gauged volume, fuel temperatures, delivery variance (ticketed volume-gauged volume), and Bill of Lading number. You can print a delivery report for: the current and previous reconciliation periods for all tanks in a system, the current and previous reconciliation periods for a single tank, and all the day's deliveries for a single tank. This means you can print up to 62 days (4 deliveries per day) of ticketed delivery information when you print a report for all the tanks in your system. Press FUNCTION until you see the message below. Then press PRINT to print a Delivery Report for all tanks in the system:

```
DELIVERY MAINTENANCE
PRESS <STEP> TO CONTINUE
```

Press STEP to continue. The system displays this message:

```
EDIT/VIEW OR INSERT
SELECT: EDIT/VIEW
```

Press STEP to continue. The system displays the message below. To select other tanks in the system, press TANK/SENSOR. Press PRINT to print a Delivery Report for all deliveries for the tank shown.

```
SELECT: EDIT/VIEW
T 1: UNLEADED GASOLINE
```

Press STEP to continue. The system displays this message below. Press PRINT to print a Delivery Report for all deliveries for the day and tank shown.

```
T 1: XXX XX, XXXX XX:XXXX
TICKET VOLUME: XXX
```

An example of a Delivery Report is shown below. Volumes can be either standard or temperature-compensated. This feature is selected in the Setup Mode. When you insert ticketed deliveries, gauged volume and temperature information appear as "UNAVAIL" (unavailable) on the report.

```
T 1:UNLEADED GASOLINE
TICKETED DELIVERY REPORT
MMM DD, YYYY HH:MM XM
VOLUMES ARE STANDARD

MMM DD, YYYY HH:MM XM

TICKET VOL      : 2500 GALS
GAUGED VOL      : 2599 GALS
DLVY VAR        :  -99 GALS
EST DLVY TEMP   :   72.9 F
PRE DLVY TEMP   :   72.6 F
POST DLVY TEMP  :   73.2 F
BOL             :  EXX23223
```

6 Tanker Load Report

Tanker Load Reports show the volume of fluid pumped from a tank to a road tanker. The volume of fuel pumped each time is referred to as a "load."

The system automatically assigns a sequence number in ascending order to each load. The sequence number is reset to one at the beginning of each day (12:00 am). Up to 40 loads per tank will be recorded in a day. If more than 40 loads are pumped in a day, the oldest load will be deleted and the newest load will have a sequence number of 41.

You can view or print specific Tanker Load Reports. To select Tanker Load Report, press FUNCTION until you see the message:

```
TANKER LOAD REPORT
PRESS <STEP> TO CONTINUE
```

NOTE: Tanker Load Report is a key-enabled option. This feature may not be available on your system.

All Tanks

Press PRINT to print all Tanker Load Reports for all tanks in the system.

Specific Tanks

Press STEP to view the Tanker Load Report for a specific tank:

```
T #: UNLEADED GASOLINE
PRESS <PRINT> FOR REPORT
```

Press PRINT to print all the reports for this tank. To view reports for other tanks in the system, press TANK.

Single Tank and Load Number

To view the Tanker Load Report for a specific tank's last load, press STEP until you see the message:

```
T #: DATE #(LOAD NO.)
TOTAL = XXXX GALS
```

Press PRINT to print the report for this delivery load.

A sample report is shown below. This report is for tank 1, load 1. The load contained 553 gallons.

```
MMM DD, YYYY HH:MM XM
TANKER LOAD REPORT

T 1: (product label)

NUMBER: 1

LOAD START:
MMM DD, YYYY HH:MM XM

VOLUME      =  9975 GALS
TC VOLUME   =  9974 GALS
TEMP        =  74.4 DEG F

LOAD END:
MMM DD, YYYY HH:MM XM

VOLUME      =   553 GALS
TC VOLUME   =   552 GALS
TEMP        =  60.0 DEG F

TOTAL       =  9422 GALS
TC TOTAL    =  9422 GALS
```

Press ← or → to view the Tanker Load Report for the previous or next load number. To view reports for load numbers of other tanks in the system, press TANK.

7 Fuel Management

Fuel Management estimates the number of days remaining before you will receive a LOW PRODUCT ALARM. Fuel Management also keeps track of the average daily sales for each product.

Note: Fuel Management is an option. If you do not have the **Fuel Manager** software module key, you will not be able to access this function.

To select Fuel Management, press FUNCTION until you see the message

```
FUEL MANAGEMENT
PRESS <STEP> TO CONTINUE
```

Press PRINT to print a Fuel Management report for all products.

Short Report

A Short Report lists the days of fuel remaining, inventory, and 95% ullage for all tanks. To print a Short Report, press STEP until you display the message:

```
FUEL MANAGEMENT
PRINT SHORT REPORT
```

Press PRINT. A sample report is shown below:

```
MMM DD, YYYY HH:MM XM
T 1: (product label)
DAYS FUEL REMAINING      :      2.4
INVENTORY                 : 2453 GALS
95% ULLAGE                : 7047 GALS
T 2: (product label)
DAYS FUEL REMAINING      :      3.8
INVENTORY                 : 3107 GALS
95% ULLAGE                : 6393 GALS
```

Days Fuel Remaining

You can display and print how many days of fuel you have remaining before you receive a LOW PRODUCT ALARM. The system displays the days of fuel remaining for all tanks containing the product. The product name displayed is of the lowest tank number containing the product.

Note: The system assumes tanks with the same product code contain the same product. All information displayed is for products, not tanks. The product name is the product label of the lowest tank number containing the product. The product code is a single character designating the type of product. The product code can be setup using In-Tank Setup. Refer to the System Setup Manual for more information.

To display the days of fuel remaining, press STEP until you see the message:

```
PRODUCT NAME
DAYS FUEL REMAINING: X.X
```

For example, if you had 2.4 days of regular unleaded fuel remaining, the system would display the message:

```
REGULAR UNLEADED
DAYS FUEL REMAINING: 2.4
```

Press TANK to view the days of fuel remaining for a different product. Press PRINT to print a report of the days of fuel remaining for all tanks containing the product and the average daily sales for the product.

Inventory

To display the inventory for all tanks containing the selected product, press STEP until you see the message:

```
(Product Name)
INVENTORY      XXXX GAL
```

Press TANK to display the inventory for a different product. Press PRINT to print a report of the inventory for all tanks containing the product.

95% Ullage

Ullage is the amount of room left in the tank. 95% ullage is the amount of fuel required to make the tank 95% full. To determine the 95% ullage, press STEP until you see the message:

```
PRODUCT NAME
95% ULLAGE = XXXXX (UNITS)
```

For example, if the system displays the message:

```
REGULAR UNLEADED
95% ULLAGE = 7037 GAL
```

you would have to add 7,037 gallons of product to fill the tank to 95% capacity. Press TANK to view 95% ullage for other tanks in the system. Press PRINT to get a report of the days of fuel remaining, inventory, 95% ullage, and average daily sales.

Average Daily Sales

The average daily sales is the average of the total daily sales accumulated for a 24 hour period. The system then continues to collect data for sales on that particular day and adjusts the average accordingly.

To view the Average Daily Sales, press STEP until you display the message:

```
PRODUCT NAME
AVG SALES-SUN: XXX (UNITS)
```

For example, if your average daily sales for Sundays of regular unleaded fuel was 983 gallons, the system would display the message:

```
REGULAR UNLEADED
AVG SALES-SUN:983 GAL
```

Press STEP to view the average daily sales for the next day. Press TANK to view the average daily sales for a different product. Press PRINT to print a report of the average daily sales, for example:

```
MMM DD, YYYY HH:MM XM
T 1: (product label)
DAYS FUEL REMAINING :      2.4
INVENTORY           :    2453 GALS
95% ULLAGE          :    7047 GALS

T 2: (product label)
DAYS FUEL REMAINING :      3.8
INVENTORY           :    3107 GALS
95% ULLAGE          :    6393 GALS

AVG SALES-SUN       :     983 GAL
AVG SALES-MON       :    1243 GAL
AVG SALES-TUE       :    1007 GAL
AVG SALES-WED       :    1129 GAL
AVG SALES-THR       :    1095 GAL
AVG SALES-FRI       :    1362 GAL
AVG SALES-SAT       :    1043 GAL
```

8 Last-Shift Inventory

Last-Shift Inventory displays what the inventory was in each tank for up to four shifts when the shift was closed. To select Last-Shift Inventory, press FUNCTION until you display the message:

```
LAST-SHIFT INVENTORY
PRESS <STEP> TO CONTINUE
```

Press PRINT to print a Last-Shift Inventory Report. The system will print a report for all shifts for up to eight tanks. For example:

```
SHIFT STARTING INV #1
-----
MMM DD, YYYY HH:MM XM

T 1: (product label)
VOLUME           :    8518 GALS
ULLAGE           :    1482 GALS
90% ULLAGE       :     482 GALS
TC VOLUME        :    8492 GALS

WATER VOL        :         0 GALS
WATER            :     0.00 INCHES
TEMP             :     64.6 DEG F

DLVY ADJUSTMENT  :         0
GROSS CHANGE     :         0
TC NET CHANGE    :         0

HEIGHT           :    76.26 INCHES
```

Beginning Inventory

The beginning inventory is the amount of product in a tank at the beginning of a shift. To view the beginning inventory for the first shift, press STEP until you display the message:

```
T #: SHIFT TIME #
BEGIN INVENTORY: XXXXXX
```

To view the beginning inventory for the other tanks in the system, press TANK. To generate a report, press PRINT. To view the beginning inventory for the next shift, continue to press STEP until you display the BEGIN INVENTORY message for the next shift.

End Inventory

The ending inventory is the amount of product in a tank at the end of a shift. To view the ending inventory for the shift, press STEP until you see the message:

```
T #: SHIFT TIME #
END INVENTORY: XXXXXX
```

To view the ending inventory for other tanks in the system, press TANK. To view the ending inventory for the next shift, continue to press STEP until you display the BEGIN INVENTORY message for the next shift. To generate an Ending Inventory Report, press PRINT.

Delivery Adjustment

For consoles with Ticketed Delivery, this feature is available only if ticketed delivery is disabled in the Setup Mode. To enter a delivery adjustment, press STEP until you display the message:

```
T#: SHIFT TIME #
DLVY ADJUSTMENT: XXXXXX
```

Press CHANGE, then enter the amount of the delivery indicated on the slip given to you by the tanker operator (if multiple deliveries were made into the tank, enter the total amount from the tickets). To ensure an accurate record of events, enter this adjustment during the shift in which the delivery(ies) occurred. Press ENTER.

If more than one shift is programmed in the system, press STEP to view the Ticketed Delivery for each shift.

Gross Change

Gross Change is the beginning shift inventory, minus the end shift inventory, plus any ticketed deliveries made during that shift. Press STEP until you display the message:

```
T #: SHIFT TIME #X
GROSS CHANGE: XXXXX
```

Close Current Shift Now

To manually close the current shift, select the Last-Shift Inventory function, if necessary. Press STEP until you display the message:

```
CLOSE CURRENT SHIFT
CLOSE NOW: NO
```

This command can only be invoked once an hour. A shift inventory report is printed and the next shift automatically begins when you manually close a shift. Also, the current shift's "Shift Ending Inv" and the next shift's "Shift Starting Inv" info will be updated with the current inventory data. Press CHANGE, ENTER, then STEP to close the current shift.

9 In-Tank Test Results

An In-Tank Leak Test is a Periodic (0.2 gph [0.76 lph]) or Annual (0.1 gph [0.38 lph]) leak test that is run to determine if the tank is leaking. Annual leak tests are only possible with the 0.1 Mag probes. This function lets you view and print In-Tank Leak Test results. Table 29-3 on page 29-4 lists the reasons for a failed tank test and Table 29-4 on page 29-6 lists the reasons for an invalid tank test.

Note: If Averaging was selected during In-Tank Setup, the system generates Average Leak Test Reports instead of In-Tank Test Reports. Averaging takes the last five test rates and averages them to determine the leak rate. For more information, refer to the System Setup Manual.

To print In-Tank Test Results for all tanks, press FUNCTION until you display the message:

```
IN-TANK TEST RESULTS
PRESS <STEP> TO CONTINUE
```

Press PRINT. The report shows whether or not the tanks passed or failed the leak test. For example:

```
MMM DD, YYYY HH:MM XM
LEAK TEST REPORT
T 1: (product label)
PROBE SERIAL NUM 105792
TEST STARTING TIME:
MMM DD, YYYY HH:MM XM
TEST LENGTH = 4.3 HRS
STRT VOLUME = 3725 GALS
LEAK TEST RESULTS
0.2 GAL/HR TEST PASS
```

Gross Test Results

Gross Test Results are the results from 3.0 gph (11.3 lph) leak tests. To view Gross Test Results, press STEP until you see the message:

```
T 1: (Product Name)
GRS: (Date) (Results)
```

To print the results for the selected tank, press PRINT. The report also prints out the serial number of the probe you are using in the tank. To view Gross Test Results for other tanks in the system, press TANK.

Note: Gross Test Results will not appear unless this function was enabled during In-Tank Setup.

Periodic Test Results

Periodic Test Results are the results from 0.2 gph (0.76 lph) leak tests. To view Periodic Test Results, press STEP until you see the message:

```
T #: (Product Name)
PER: (Date) (Results)
```

The system prints the date the test ran and the results (PASS, FAIL, or INVALID) for the selected tank. Press PRINT to print the Periodic Test Results. Press TANK to view the Periodic Test Results for other tanks in the system.

Annual Test Results

Annual Test Results are the results from the 0.1 gph (0.38 lph) leak test. Note: Annual Tests Results only appear if the tank is equipped with a 0.1 Mag probe.

To view Annual Test Results, press STEP until you see the message:

```
T #: (Product Name)
ANN: (Date) (Results)
```

To print the Annual Test Results, press PRINT.

The Annual Test Results shows the test starting time, test length, starting volume, and test results (PASS, FAIL, or INVALID). See example below:

```
MMM DD, YYYY HH:MM XM
LEAK TEST REPORT
T 1: (product label)
PROBE SERIAL NUM 105792
TEST STARTING TIME:
MMM DD, YYYY HH:MM XM
TEST LENGTH = 4.3 HRS
STRT VOLUME = 3725 GALS
LEAK TEST RESULTS
0.1 GAL/HR TEST PASS
```

10 CSLD Test Results

Continuous Statistical Leak Detection, CSLD, is a tank leak detection method that allows the tank to be tested without shutting down the tank and significantly reduces the false alarm risk. CSLD continuously monitors the tank level to determine when the tank is idle (no dispensing or deliveries in progress). A single leak test is then performed during the identified idle period. The result of this test is added to a database of leak test results. The database is statistically analyzed to produce a final test result.

Note: CSLD is an option. You must have a 0.1 gph Mag probe and have the **CSLD** software module key installed to perform CSLD tests.

TLS-3XX Consoles

Test results are provided automatically every 24 hours. You can also obtain current CSLD leak test results by pressing PRINT from within the CSLD Test Results function.

To view CSLD leak results, press FUNCTION until you display the message:

```
CSLD TEST RESULTS
PRESS <STEP> TO CONTINUE
```

To print out a CSLD report for tanks specified during system setup, press PRINT. For example:

```
CSLD TEST RESULTS
-----
DD-MM-YY HH:MM XM

T 2: (product label)

PROBE SERIAL NUM 123002
0.2 GAL/HR TEST
PER: DD-MM-YY PASS
```

Press STEP to view the CSLD test results. The system displays the message:

```
T 2: (Product Name)
PER: (Results)
```

Press TANK to view the Periodic Test (0.2 gph leak test) results for other tanks in the system that use CSLD. Press PRINT to print CSLD Test Results (Pass/Fail) for the selected tank.

TLS-350 Plus/TLS-350R Consoles

Test results are provided automatically every 24 hours except when the CSLD Report Only feature is enabled in setup.

To view CSLD leak results, press FUNCTION until you display the message:

```
CSLD TEST RESULTS
PRESS <STEP> TO CONTINUE
```

Press STEP and the message displays:

```
CSLD CURRENT TST RESULTS
PRESS <ENTER>
```

Press ENTER to view the CSLD test result the tank. The system displays the message:

```
T #: (Product Name)
PER: (Results)
```

To print out the current CSLD test report for the tank, press PRINT. For example:

```
CSLD TEST RESULTS
-----
DD-MM-YY HH:MM XM

T #: (product label)
PROBE SERIAL NUM 123002

0.2 GAL/HR TEST
PER: DD-MM-YY PASS
```

Press TANK to view the current CSLD test results for other tanks in the system. Press BACKUP, then STEP to continue.

```
CSLD FULLEST LAST PASS
PRESS <ENTER>
```

This display refers to the one passed test out of all passed tests in the last month in which the tank was most full. Press ENTER to view the fullest last passed CSLD test result. The system displays the message:

```
T #: (Product Name)
PER: (Results)
```

To print out the fullest last passed CSLD test result, press PRINT. For example:

```
CSLD FULLEST LAST PASS
-----
DD-MM-YY HH:MM XM

T #: (product label)
PROBE SERIAL NUM 123002

0.2 GAL/HR TEST
PER: DD-MM-YY
```

Press TANK to view the fullest last passed test results for other tanks in the system that use CSLD.

Press FUNCTION to exit CSLD Test Results.

11 PLLD Tests

The Pressurized Line Leak Detection (PLLD) system can run tests manually, or automatically to eliminate the need for separate annual tests. The system tests for leaks using highly accurate pressure measurements for 3.0, 0.2, and 0.1 gph (11.3, 0.76, and 0.38 lph) line leak tests.

Note: The ability to perform 0.2 gph and 0.1 gph tests are options. If you did not purchase these options, you will not be able to perform these tests.

The system performs 0.2 gph and 0.1 gph tests with the pump On for greater accuracy.

To view Pressurized Line Leak Test results, press FUNCTION until you display the message:

```
PRESSURE LINE RESULTS
PRESS <STEP> TO CONTINUE
```

To print a complete Pressurized Line Leak test report for all lines, press PRINT. The system prints the test results for the last test, as well as the number of 3.0 gph tests run in the previous 24 hours and since midnight of the current day. It also prints results of the last ten 0.2 gph tests and the last ten 0.1 gph tests.

3.0 gph (11.3 lph) Tests

The PLLD system attempts to run a 3.0 gph test after every dispensing transaction. To display the last 3.0 gph test results for a selected line, press STEP until you display the message:

```
Q #: PLLD #X
DATE      3.0 PASSED
```

To view 3.0 gph test results for other lines in the system, press TANK/SENSOR. To print 3.0 gph, 0.2 gph, and 0.1 gph test results for the line selected, press PRINT. A sample report is shown below:

```
MMM DD, YYYY HH:MM XM
PRESSURE LINE LEAK TEST RESULTS
Q 1: (product label)
3.0 GAL/HR RESULTS:
LAST TEST:
MMM DD, YYYY HH:MM XM PASS
NUMBER OF TESTS PASSED
PREV 24 HOURS   =           123
SINCE MIDNIGHT =           81
0.20 GAL/HR RESULTS:
MMM DD, YYYY HH:MM XM PASS
MMM DD, YYYY HH:MM XM PASS
0.10 GAL/HR RESULTS:
MMM DD, YYYY HH:MM XM PASS
MMM DD, YYYY HH:MM XM PASS
```

0.2 gph (0.76 lph) Tests

To view the last 0.2 gph test results, press STEP to display the message:

Q #: PLLD NUMBER # DATE 0.20 PASSED

To view 0.2 gph test results for other lines in the system, press TANK/SENSOR. To print 0.2 gph test results for the line selected, press PRINT.

0.1 gph (0.38 lph) Tests

To view the last 0.1 gph test results, press STEP to display the message:

Q #: PLLD NUMBER # DATE 0.10 PASSED

To view 0.1 gph test results for other lines in the system, press TANK/SENSOR. To print 0.1 gph test results for the line selected, press PRINT.

History Reports

A PLLD history report prints the last 3.0 gph, the first 0.2 gph, and the first 0.1 gph test results for each month. To print a PLLD history report, press STEP to display the message:

Q #: PLLD NUMBER # PRESS PRINT FOR HISTORY

Press PRINT to print the report. For example:

```

MMM DD, YYYY HH:MM XM

PRESSURE LINE LEAK TEST HISTORY

Q 1: (product label)

LAST 3.0 GAL/HR PASS:
MMM DD, YYYY HH:MM XM

FIRST 0.20 GAL/HR PASS EACH MONTH:

MMM DD, YYYY HH:MM XM
MMM DD, YYYY HH:MM XM
MMM DD, YYYY HH:MM XM
MMM DD, YYYY HH:MM XM

FIRST 0.10 GAL/HR PASS EACH MONTH:

MMM DD, YYYY HH:MM XM
MMM DD, YYYY HH:MM XM
MMM DD, YYYY HH:MM XM
MMM DD, YYYY HH:MM XM
    
```

Start Pressurized Line Leak Test

You can run a pressurized line leak test on all lines or on a single line. To start a Pressurized Line Leak Test, press FUNCTION to display the message:

**START LINE PRESSURE TEST
PRESS <STEP> TO CONTINUE**

SELECT ALL LINES OR A SINGLE LINE

Press STEP. The system displays the message:

**SELECT LINE
ALL LINES**

Press STEP to accept all lines or CHANGE, then ENTER to select a single line, then press STEP.

SELECT TEST TYPE

This step lets you select a 3.0, 0.2, or 0.1 gph (11.3, 0.76, or 0.38 lph) line leak test to run on the selected line(s). If your system does not have 0.2 or 0.1 gph test options, you will not see these selections. See the test notes below for more detail.

**SELECT TEST TYPE
3.0 GPH**

Manual Test Notes:

- The test type choices are limited by the system options and the line type test capability.
- If the 0.2 or 0.1 gph line test option is available, but it was Disabled in PLLD 0.2 or 0.1 gph Test Schedule setups, then you can not start those test types manually.
- Tests always run in the order: 3.0 gph, 0.2 gph, and 0.1 gph.
- Approximate test times, assuming no dispense (which would restart the test(s) after the dispense) and no thermals, are 3.0 gph - several minutes, 0.2 gph - 30 minutes, and 0.1 gph - 45 minutes.
- A 3.0 gph test runs that test only.
- A 0.2 gph test is automatically preceded by a 3.0 gph test. Selecting a 0.2 gph test bypasses the 0.2 Line Test Auto-Confirm system setup selection (if enabled).
- A 0.1 gph test is automatically preceded by 3.0 gph and 0.2 gph tests. Selecting a 0.1 gph test bypasses the 0.2 and 0.1 gph Line Test Auto-Confirm system setup selections (if enabled).

To select 3.0 gph test, press STEP. Press CHANGE to select 0.2 or 0.1 gph tests, then press ENTER. To select a 3.0 gph line leak test, press STEP.

**3.0 GPH
PRESS <STEP> TO CONTINUE**

For another test type, press CHANGE until the available test you want is displayed, then press ENTER.

START TEST

To run the selected leak test, press STEP. The system displays the message (in this example for all lines):

**START LINE TEST: ALL LINE
PRESS <ENTER>**

Press ENTER to begin the test. The system displays the message:

**Q #: RUNNING PUMP
PRESS <STEP> TO CONTINUE**

To exit this function, press STEP.

Stop Pressurized Line Leak Test

Stop Pressure Test stops PLLD tests on all lines or on a single line. To stop a Pressurized Line Leak Test, press FUNCTION until you display the message:

**STOP PRESSURE TEST
PRESS <STEP> TO CONTINUE**

Press STEP. The system displays the message:

**SELECT LINE
ALL LINES**

ALL LINES

To stop PLLD tests on all lines, press ENTER or STEP. When you press ENTER or STEP, the system displays the message:

**STOP LINE TEST: ALL LINES
PRESS <ENTER>**

Press ENTER to stop PLLD tests on all lines. The system displays the status message:

**Q #: TEST ABORTED
PRESS <STEP> TO CONTINUE**

The system stops PLLD tests on all lines. To exit this function, press FUNCTION.

SINGLE LINE

To stop PLLD tests on a single line, press CHANGE in response to the message below:

**SELECT LINE
ALL LINES**

When you press CHANGE, the system displays the message:

```
SELECT LINE
Q #: PLLD #X
```

Press ENTER. To select a different line, press CHANGE until you display the line you want to select, then press ENTER. The system displays the message:

```
STOP LINE TEST: LINE (#)
PRESS <ENTER>
```

Press ENTER to stop the PLLD test on the selected line. The system stops the test and advances to the next line in test.

```
Q #: TEST ABORTED
PRESS <STEP> TO CONTINUE
```

When you have stopped PLLD tests on the desired lines, press FUNCTION to exit.

12 WPLLD Tests

The Wireless Pressurized Line Leak Detection (WPLLD) system can run 3.0 gph, 0.2 gph, or 0.1 gph (11.3, 0.76, or 0.38 lph) tests manually, or automatically to eliminate the need for separate annual tests. The system tests for leaks using highly accurate pressure measurements.

Note: The ability to perform 0.2 gph and 0.1 gph tests are options. If you did not purchase these options, you will not be able to perform these tests.

The system performs 0.2 gph and 0.1 gph tests with the pump on for greater accuracy.

To view Wireless Pressurized Line Leak Test results, press FUNCTION until you display the message:

```
WPLLD LINE RESULTS
PRESS <STEP> TO CONTINUE
```

To print a complete Wireless Pressurized Line Leak test report for all lines, press PRINT. The system prints the test results for the number of 3.0 gph tests passed in the previous 24 hours and the number passed since midnight. It also prints results of the last ten 0.2 gph tests and the last ten 0.1 gph tests. If no test has yet been run for a selected line, the display will read NO X.X RESULTS AVAILABLE, where X.X is 3.0, 0.2, or 0.1.

3.0 gph (11.3 gph) Tests

The WPLLD system attempts to run a 3.0 gph test after every dispensing transaction. To display the last 3.0 gph test results for a selected line, press STEP until you display the message:

```
W #: WPLLD #X
DATE      3.0 PASSED
```

To view 3.0 gph test results for other lines in the system, press TANK/SENSOR. To print 3.0 gph, 0.2 gph, and 0.1 gph test results for the line selected, press PRINT. A sample report is shown below:

```
MMM DD, YYYY HH:MM XM
WPLLD LINE LEAK TEST RESULTS
W 1: (product label)
3.0 GAL/HR RESULTS:
LAST TEST:
MMM DD, YYYY HH:MM XM PASS
NUMBER OF TESTS PASSED
PREV 24 HOURS   =      123
SINCE MIDNIGHT =      81
0.20 GAL/HR RESULTS:
MMM DD, YYYY HH:MM XM PASS
MMM DD, YYYY HH:MM XM PASS
0.10 GAL/HR RESULTS:
MMM DD, YYYY HH:MM XM PASS
MMM DD, YYYY HH:MM XM PASS
```

0.2 gph (0.76 lph) Tests

To view the last 0.2 gph test results, press STEP to display the message:

W #: WPLLD NUMBER #
DATE 0.20 PASSED

To view 0.2 gph test results for other lines in the system, press TANK/SENSOR. To print 0.2 gph test results for the line selected, press PRINT.

0.1 gph (0.38 lph) Tests

To view the last 0.1 gph test results, press STEP to display the message:

W #: WPLLD NUMBER #
DATE 0.10 PASSED

To view 0.1 gph test results for other lines in the system, press TANK/SENSOR. To print 0.1 gph test results for the line selected, press PRINT.

History Reports

A WPLLD history report prints the last 3.0 gph, the first 0.2 gph, and the first 0.1 gph test results for each month. To print a WPLLD history report, press STEP to display the message:

W #: WPLLD NUMBER #
PRESS <PRINT> FOR HISTORY

Press PRINT to print the report. For example:

```

MMM DD, YYYY HH:MM XM

WPLLD LINE LEAK TEST HISTORY

W 1: (product label)

LAST 3.0 GAL/HR PASS:
MMM DD, YYYY HH:MM XM

FIRST 0.20 GAL/HR PASS EACH MONTH:

MMM DD, YYYY HH:MM XM
MMM DD, YYYY HH:MM XM
MMM DD, YYYY HH:MM XM
MMM DD, YYYY HH:MM XM

FIRST 0.10 GAL/HR PASS EACH MONTH:

MMM DD, YYYY HH:MM XM
MMM DD, YYYY HH:MM XM
MMM DD, YYYY HH:MM XM
MMM DD, YYYY HH:MM XM

```

Start Wireless Pressurized Line Leak Test

You can run wireless pressurized line leak tests on all lines or on a single line. To start a Wireless Pressurized Line Leak Test, press FUNCTION to display the message:

**START WPLLD LINE TEST
PRESS <STEP> TO CONTINUE**

SELECT ALL LINES OR A SINGLE LINE

Press STEP. The system displays the message:

**SELECT LINE
ALL LINES**

Press STEP to accept all lines or CHANGE, then ENTER to select a single line, then press STEP.

SELECT TEST TYPE

This step lets you select a 3.0, 0.2, or 0.1 gph (11.3, 0.76, or 0.38 lph) line leak test to run on the selected line(s). If your system does not have 0.2 or 0.1 gph test options, you will not see these selections. See the test notes below for more detail.

**SELECT TEST TYPE
3.0 GPH**

Manual Test Notes:

- The test type choices are limited by the system options and the line type test capability.
- If the 0.2 or 0.1 gph line test option is available, but it was Disabled in WPLLD Test Schedule setup, then you can not start those test types manually.
- Tests always run in the order: 3.0 gph, 0.2 gph, and 0.1 gph.
- Approximate test times, assuming no dispense (which would restart the test(s) after the dispense) and no thermals, are 3.0 gph - several minutes, 0.2 gph - 30 minutes, and 0.1 gph - 45 minutes.
- A 3.0 gph test runs that test only.
- A 0.2 gph test is automatically preceded by a 3.0 gph test. Selecting a 0.2 gph test bypasses the 0.2 Line Test Auto-Confirm system setup selection (if enabled).
- A 0.1 gph test is automatically preceded by 3.0 gph and 0.2 gph tests. Selecting a 0.1 gph test bypasses the 0.2 and 0.1 gph Line Test Auto-Confirm system setup selections (if enabled).

To select 3.0 gph test, press STEP. Press CHANGE to select 0.2 or 0.1 gph tests, then press ENTER. To select a 3.0 gph line leak test, press STEP.

**3.0 GPH
PRESS <STEP> TO CONTINUE**

For another test type, press CHANGE until the available test you want is displayed, then press ENTER.

START TEST

To run the leak test, press STEP. The system displays the message (in this example for all lines):

```
START LINE TEST: ALL LINES  
PRESS <ENTER>
```

Press ENTER to begin the test. The system displays the message:

```
W #: TEST PENDING  
PRESS <STEP> TO CONTINUE
```

To exit this function, press STEP.

Stop Wireless Pressurized Line Leak Test

To stop a Wireless Pressurized Line Leak Test, press FUNCTION until you display the message:

```
STOP WPLLD LINE TEST  
PRESS <STEP> TO CONTINUE
```

Press STEP. The system displays the message:

```
SELECT LINE  
ALL LINES
```

ALL LINES

To stop the WPLLD test on all lines, press ENTER or STEP.

When you press ENTER or STEP, the system displays the message:

```
STOP LEAK TEST: ALL LINES  
PRESS <ENTER>
```

Press ENTER to stop the test on all the lines. The system displays the status message:

```
W#: TEST ABORTED  
PRESS <STEP> TO CONTINUE
```

The system stops the test on all lines. To exit this function, press FUNCTION.

SINGLE LINE

To stop the WPLLD test on a single line, press CHANGE in response to the message below:

```
SELECT LINE  
ALL LINES
```

When you press CHANGE, the system displays the message:

SELECT LINE
W#: WPLLD #X

Press ENTER. To select a different line, press CHANGE until you display the line you want to select, then press ENTER. The system displays the message:

STOP LEAK TEST: LINE (#)
PRESS <ENTER>

Press ENTER to stop the line test on the selected line. The system stops the test and advances to the next line in test.

W#: TEST ABORTED
PRESS <STEP> TO CONTINUE

When you have stopped all of the tests you want to stop, press FUNCTION to exit.

13 VLLD Tests

The Volumetric Line Leak Detection (VLLD) system measures the leak rate at pump operating pressure. The system automatically attempts to do a 3.0 gph (11.3 lph) test when the dispenser is shut off. It also attempts 0.2 and 0.1 gph (0.76 and 0.38 lph) tests once every 12 hour period. In addition to the automatic tests, the system can be programmed to run 0.2 gph or 0.1 gph tests at a specific time.

The VLLD system automatically runs a selftest after every line test. If the VLLD system fails the selftest, it will cause an alarm. The system will also perform a pumpside test if this function was enabled during system setup.

Note: Pumpside tests will only occur if Pumpside Test is enabled in the VLLD Setup. See the System Setup Instructions for more information.

To view Volumetric Line Leak results, press FUNCTION until you display the message:

**LINE LEAK DETECT RESULTS
PRESS <STEP> TO CONTINUE**

To print a complete Volumetric Line Leak Test history report by pipeline, press PRINT. The report shows:

- The number of 3.0 gph line tests, selftests, and pumpside tests (if enabled) run during the previous 24 hours and since midnight.
- The results of the last twelve 0.2 gph tests.
- The results of the last twelve 0.1 gph tests.

Test Reports

0.2 GPH TESTS

To view a Volumetric Line Leak History Report by line for 0.2 gph tests, press STEP until you display the message:

**P#: LINE LEAK NUMBER #
DATE (0.2 GPH Test Result)**

To print a report for the line selected, press PRINT. To select a different line, press TANK/SENSOR.

0.1 GPH TESTS

To view volumetric line leak test results by line for 0.1 gph tests, press STEP until you display the message:

**P#: LINE LEAK NUMBER #
DATE (0.1 GPH Test Result)**

To print a report for the line selected, press PRINT.

Start Volumetric Line Leak Test

To start a volumetric line leak test, press FUNCTION until you display the message:

```
START LINE LEAK TEST
PRESS <STEP> TO CONTINUE
```

Press STEP. The system displays the message:

```
START LEAK TEST METHOD
ALL LINES
```

ALL LINES

To run a volumetric leak test on all lines, press STEP. To run the test on a single line, follow the procedures for a "Single Line" on page 13-2. When you press STEP, the system displays the message:

```
TEST RATE: ALL LINES
0.20 GAL/HR
```

If you want to run a 0.2 gph (0.76 lph) test, press STEP.

OR

If you want to run a 0.1 gph (0.38 lph) test, press CHANGE, then press ENTER.

OR

To select the Air Purge procedure, refer to "Air Purge" on page 13-3.

When you press ENTER, the system displays the message:

```
0.10 GAL/HR
PRESS <STEP> TO CONTINUE
```

Press STEP. The system displays the message:

```
START LEAK TEST: ALL LINES
PRESS <ENTER>
```

Press ENTER to start the test. The system begins the line leak, displays the message:

```
START LEAK TEST: ALL LINES
PRESS <ENTER>
```

and prints a report that the test has started. To exit this function, press FUNCTION.

SINGLE LINE

To run the leak test on a single line, press CHANGE in response to the message:

```
START LEAK TEST METHOD
ALL LINES
```

When you press CHANGE, the system displays the message:

**START LEAK TEST METHOD
SINGLE LINE**

Press ENTER to confirm your selection. The system displays the message:

**SINGLE LINE
PRESS <STEP> TO CONTINUE**

Press STEP. The system displays the message:

**TEST RATE: LINE #
0.20 GAL/HR**

To run a 0.2 gph (0.76 lph) leak test on the line displayed, press STEP. To run a 0.1 gph (0.38 lph) leak test, press CHANGE, then press ENTER. The system displays the message:

**START LEAK TEST: LINE #
PRESS <ENTER>**

Press ENTER to start the line leak test. The system prints a confirmation that it has started the test. To start the test on another line, repeat this procedure. To exit this function, press FUNCTION.

Air Purge

Air Purge purges air from the VLLD Controller by performing six consecutive VLLD Controller 3.0 gph selftests. This routine is designed for use when setting up or servicing a VLLD Controller.

PURGING AIR FROM ALL LINES

To run the Air Purge procedure on all lines, press STEP. To run the procedure on a single line, follow the procedures on page 13-4.

If necessary press FUNCTION, until you display the message:

**START LINE LEAK TEST
PRESS <STEP> TO CONTINUE**

Press STEP. The system displays the message:

**START LEAK TEST METHOD
ALL LINES**

Press STEP. The system displays the message:

**TEST RATE: ALL LINES
0.20 GAL/HR**

Press CHANGE twice to display the message:

**TEST RATE: ALL LINES
AIR PURGE PROCEDURE**

Press ENTER to select the Air Purge Procedure. The system displays the message:

```
AIR PURGE PROCEDURE  
PRESS <STEP> TO CONTINUE
```

Press STEP. The system displays the message:

```
START LEAK TEST: ALL LINES  
PRESS <ENTER>
```

Press ENTER. The system returns to the Start Line Leak Test message.

PURGING AIR FROM A SINGLE LINE

To purge air from a single line, press FUNCTION until you display the message:

```
START LINE LEAK TEST  
PRESS <STEP> TO CONTINUE
```

Press STEP. The system displays the message:

```
START LEAK TEST METHOD  
ALL LINES
```

Press CHANGE. The system displays the message:

```
START LEAK TEST METHOD  
SINGLE LINE
```

Press ENTER. The system displays the message:

```
SINGLE LINE  
PRESS <STEP> TO CONTINUE
```

Press STEP. The system displays the message:

```
TEST RATE: LINE 1  
0.20 GAL/HR
```

Press CHANGE, if necessary, until you display the Air Purge Procedure:

```
TEST RATE: LINE 1  
AIR PURGE PROCEDURE
```

Press STEP. The system displays the message:

```
START LEAK TEST: LINE #  
PRESS <ENTER>
```

The system starts the test and returns to the Start Line Leak Test message.

Press STEP. The system displays the message:

```
START LEAK TEST: ALL LINES  
PRESS <ENTER>
```

Press ENTER. The system returns to the Start Line Leak Test message.

Stop Volumetric Line Leak Tests

To select the Stop Line Leak Test function, press FUNCTION until you display the message:

```
STOP LINE LEAK TEST
PRESS <STEP> TO CONTINUE
```

Press STEP. The system displays the message:

```
STOP LEAK TEST METHOD
ALL LINES
```

ALL LINES

To stop the leak test on all lines, press STEP. To stop the test on a single line, See "Single Line" on page 5. When you press STEP, the system displays the message:

```
STOP LEAK TEST: ALL LINES
PRESS <ENTER>
```

Press ENTER to stop the leak test on all lines. The system displays the message:

```
STOP LEAK TEST: ALL LINES
PRESS <ENTER>
```

Press ENTER. The system displays the message:

```
STOP LINE LEAK TEST
PRESS <STEP> TO CONTINUE
```

Press STEP to stop the line leak test. The system displays the message:

```
LEAK TEST NOT ACTIVE
PRESS <FUNCTION> TO CONTINUE
```

To exit the STOP LINE LEAK TEST function, press FUNCTION.

SINGLE LINE

To stop the leak test on a single line, press CHANGE in response to the message:

```
STOP LEAK TEST METHOD
ALL LINES
```

When you press CHANGE, the system displays the message:

```
SINGLE LINE
PRESS <STEP> TO CONTINUE
```

Press STEP. The system displays the message:

**STOP LEAK TEST: LINE #
PRESS <ENTER>**

Press TANK until you display the line you want to stop the test on, then press ENTER. Do not press ENTER until you select the correct line number by pressing TANK. When you press ENTER, the system stops the test:

**STOP LEAK TEST: LINE #
PRESS <ENTER>**

Press ENTER. If the line tests have been stopped and others are to continue, press FUNCTION to exit the STOP LINE LEAK TEST function. To continue, press ENTER. The system displays the message:

**STOP LEAK TEST
PRESS <STEP> TO CONTINUE**

If all active leak tests have been stopped individually, the system returns to the STOP LINE LEAK TEST message. Press STEP to continue. The system displays the message to confirm that the leak test has stopped:

**LEAK TEST NOT ACTIVE
PRESS <FUNCTION> TO CONTINUE**

Press FUNCTION to exit.

14 Pump Relay Monitor Status Reports

Pump Relay Monitor Status reports the status of the pump relays connected to the Pump Relay Monitor Module and indicates if an alarm condition exists. To select Pump Relay Monitor Status, press FUNCTION until you display the message:

```
PUMP RELAY MON STATUS
PRESS <STEP> TO CONTINUE
```

To print a complete Pump Relay Monitor Status Report, press PRINT. You can generate a report for up to 32 relays. A sample report is shown below:

```
PUMP RELAY MON STATUS
-----
MMM DD, YYYY HH:MM XM

r1: <pump monitor label>
PUMP RELAY NORMAL

r2: <pump monitor label>
PUMP RELAY NORMAL
```

To view the Pump Relay Monitor status for a particular relay, press STEP to display the message:

```
r#: (Location)
      (Status Indicator)
```

If the relay is functioning properly and no alarm conditions exist, the system displays the message PUMP RELAY NORMAL. If the sensor is not functioning normally or an alarm condition exists, the system displays a message about the status of the relay. See the "Troubleshooting" Section, Table 29-21 and for Pump Relay Monitor Status messages.

To view the Pump Relay Monitor Status for other relays in the system, press TANK/SENSOR.

15 Liquid Status Reports

Liquid Status reports the status of the liquid sensors connected to the Interstitial Sensor Module and indicates if liquid or an alarm condition exists. To select Liquid Status, press FUNCTION until you display the message:

```
LIQUID STATUS
PRESS <STEP> TO CONTINUE
```

To print a complete Liquid Status Report, press PRINT. You can generate a report for up to 64 sensors. A sample report is shown below:

```
LIQUID STATUS
-----
MMM DD, YYYY HH:MM XM

L1: UNLEADED ANNULAR
SENSOR NORMAL

L2: SUPER ANNULAR
SENSOR NORMAL
```

To view the Liquid Sensor status for a particular sensor, press STEP to display the message:

```
L#: (Location)
(Status Indicator)
```

If the sensor is functioning properly and no alarm conditions exist, the system displays the message SENSOR NORMAL. If the sensor is not functioning normally or an alarm condition exists, the system displays a message about the status of the sensor. See the "Troubleshooting" Section, Table 29-5 and following for Liquid Status sensor messages.

To view the Liquid Sensor Status for other sensors in the system, press TANK/SENSOR. To generate a Liquid Status Report for the selected sensor, press PRINT.

16 Vapor Sensor Status

A Vapor Sensor detects hydrocarbon vapors in a dry monitoring well. When the system detects vapors that exceed the threshold amount programmed in the system, it alerts you to take action to prevent serious safety and environmental problems.

Vapor Sensor Alarms

When no alarm condition exists, the system displays a SENSOR NORMAL status. When an alarm condition exists, the sensor alarm triggers a report showing the time and location of the alarm condition. For a description of the Vapor Status alarm messages, see the "Troubleshooting" section of this manual.

Vapor Sensor Status Reports

To select Vapor Sensor Status, press FUNCTION to display the message:

```
VAPOR STATUS
PRESS <STEP> TO CONTINUE
```

To print a complete Vapor Status Report for all sensors in the system, press PRINT. You can print a report for up to 40 sensors. For example:

```
VAPOR STATUS
-----
MMM DD, YYYY HH:MM XM

V1: NORTHWEST WELL
SENSOR NORMAL

V2: MAIN STREET WELL
SENSOR NORMAL
```

To view a Vapor Sensor Status Report for a specific vapor sensor, press STEP to display the message:

```
V #: (Location)
(Status Indicator)
```

The system displays the Vapor Sensor number, the location of the sensor, and the sensor status. For example:

```
V 1: NORTHWEST WELL
SENSOR NORMAL
```

To view the Vapor Sensor Status for other sensors in the system, press TANK/SENSOR. To print a Vapor Status Report for the selected sensor, press PRINT.

17 Groundwater Sensor Status

A Groundwater Sensor detects free hydrocarbon product on the water table in monitoring wells up to 20 feet deep. It also has a "Water Out" alarm to let you know that the water level has fallen below the sensor and fuel can no longer be detected.

Groundwater Sensor Alarms

When no alarm condition exists, the system displays a SENSOR NORMAL status. When an alarm condition occurs, the sensor alarm triggers a report showing the alarm condition. This condition is recorded as part of the alarm history reports. For more information on Groundwater Sensor Alarm messages, see the "Troubleshooting" section of this manual.

Groundwater Sensor Status Reports

To select Groundwater Sensor Status, press FUNCTION to display the message:

```
GROUNDWATER STATUS
PRESS <STEP> TO CONTINUE
```

To print a complete Groundwater Status Report for all sensors in the system, press PRINT. You can print a report for up to 40 sensors. For example:

```
GROUNDWATER STATUS
-----
MMM DD, YYYY HH:MM XM

G1: GROUND WATER #1
SENSOR NORMAL

G2: GROUND WATER #2
SENSOR NORMAL
```

To view a Groundwater Status Report for a specific groundwater sensor, press STEP to display the message:

```
G #: (Location) #
(Status Indicator)
```

The system displays the Groundwater Sensor number, the location of the sensor, and the sensor status. For example:

```
G 1: GROUND WATER #
SENSOR NORMAL
```

To view the Groundwater Sensor Status for other sensors in the system, press TANK/SENSOR. To print a report for the sensor selected, press PRINT.

18 2-Wire C.L. Status

The 2-Wire C.L. (Current Loop) Sensor Status lets you display/print the current condition of Discriminating Interstitial Sensors, MicroSensors, and Solid-State Containment Sensors. These sensors detect the presence of fluid in the interstitial space of a double-wall fiberglass tank and differentiate between hydrocarbons and other liquids.

2-Wire C.L. Status Reports

To access the 2-Wire C.L. Status function, press FUNCTION until you display the message:

```
2 WIRE CL STATUS  
PRESS <STEP> TO CONTINUE
```

To print a complete 2-Wire Current Loop Status Report, press PRINT. You can print a report for up to 64 sensors.

To view the status of a particular sensor in the system, press STEP. The system displays the message:

```
C#: (Location)  
(Status Indicator)
```

The system displays the location of the sensor and the status. Press TANK/SENSOR to view the 2-Wire Current Loop Status for a different sensor, or press PRINT to print a report for the selected sensor.

2-Wire C.L. Status Alarms

When no alarm condition exists, the system displays a SENSOR NORMAL status. When an alarm condition exists, the system prints a report showing the time and location of the alarm condition. For a description of the 2-Wire C.L. Status Indicators, see Table 29-15 and Table 29-16 in the "Troubleshooting" section of this manual.

19 3-Wire C.L. Status

The 3-Wire C.L. (Current Loop) Sensor Status lets you display/print the current condition of Discriminating Dispenser Pan Sensors and Discriminating Containment Sump Sensors. These sensors detect the presence of fuel in a Dispenser Pan or Containment Sump.

3-Wire C.L. Status Reports

To access the 3-Wire C.L. Status function, press FUNCTION until you display the message:

```
3 WIRE CL STATUS
PRESS <STEP> TO CONTINUE
```

To print a complete 3-Wire C.L. Status Report for all 3-wire sensors, press PRINT. You can print a report for up to 48 sensors.

To view the status of a particular sensor in the system, press STEP. The system displays the message:

```
H #: (Location) #
(Status Indicator)
```

The system displays the location of the sensor and the status. Press TANK/SENSOR to view the 3-Wire C.L. Status for a different sensor, or press PRINT to print a report for the selected sensor.

3-Wire C.L. Status Alarms

When no alarm condition exists, the system displays a SENSOR NORMAL status. When an alarm condition exists, the system prints a report showing the time and location of the alarm condition. For a description of the 3-Wire C.L. Status alarm messages, see Table 29-17 in the "Troubleshooting" section of this manual.

20 In-Tank Leak Detection Test

Regulatory Compliance

Even small leaks can cause severe environmental damage. Plan your leak detection program to comply with local, state and federal regulations governing underground storage tanks. Save all inventory reconciliation and leak test reports from the system as documentation of compliance with local, state and federal Underground Storage Tank regulations.

Note: In-tank leak tests will not be declared a "PASS" unless the product level in the tank satisfies the minimum product level defined in our Third Party certification for the leak test being performed. In-tank leak tests performed with the product level below these minimum levels will be declared "Invalid". Because the minimum product level requirements vary with local, state, and federal regulations, you need to ensure that the product level complies with the applicable regulations in your location.

What To Do If You Detect A Leak

Do not excavate tanks or take other remedial action based solely on the Inventory or Leak Test Reports! **Always confirm suspected leaks using an alternate test method or inspection technique.**

Note: The system will function accurately with only certain approved fluids. Refer to the System Setup Manual for more information.

Inventory Control Practices

Use good inventory control practices to reduce problems caused by leaking underground storage tanks. The system can, through its inventory reports, provide the required information for stored products to help you accurately prepare inventory control records. The American Petroleum Institute publication, "Recommended Practice for Bulk Liquid Stock Control at Retail Outlets," provides guidance to operators of underground storage tanks on the requirements for maintaining control of inventories.

Preparation

Follow these steps to prepare to run an In-Tank Leak Detection Test:

1. Take the product out of operation that you will be running the test on. The test requires a tank idle period, where there are no deliveries or dispensing:
 - Dispensing fuel during an In-Tank Leak Detect Test causes a SUDDEN LOSS alarm.
 - A Delivery to a tank being tested results in an invalid test.
 - Not waiting 8 hours after a delivery to begin an In-Tank Leak Detect Test results in an invalid test.
2. Make sure the ALL FUNCTIONS NORMAL message appears on the display.
3. You have several choices when performing in-tank leak tests. You can perform the leak test for all tanks or a single tank. You can also let the test run automatically or you can manually control the test to start and stop. Determine the type of test you want to run and follow the instructions in this section.
4. To ensure accurate in-tank leak test results, use these guidelines:

Table 20-1.- Minimum In-Tank Leak Test Times

Test Type	Probe Type	Minimum Test Time
0.2 gph	0.1 or 0.2 Magnetostrictive	2 hours
0.1 gph	0.1 Magnetostrictive	3 hours*

**Add one extra hour if 2" floats are installed.*

Testing All Tanks for a Timed Duration

To perform an In-Tank Leak Test for all tanks for a timed duration, press FUNCTION until you display the message:

**START IN-TANK LEAK TEST
PRESS <STEP> TO CONTINUE**

Press STEP to display the message:

**START LEAK TEST METHOD
ALL TANKS**

Press STEP. The system displays the message:

**TEST CONTROL: ALL TANKS
TIMED DURATION**

Press STEP to confirm that you want to run the test for a timed duration. The system displays the message:

**TEST CONTROL: ALL TANKS
0.20 GAL/HR**

If you want to run a 0.2 gph (0.76 lph) test, press STEP to continue. If you want to run a 0.1 gph (0.38 lph) test (only available with 0.1 Mag probes), press CHANGE, then press ENTER. The system displays the message:

**0.10 GAL/HR
PRESS <STEP> TO CONTINUE**

Press STEP to continue the test. The system displays the message:

**TEST DURATION: ALL TANKS
DURATION: XX**

To change the duration of the test (the length of time the test will run in hours), press CHANGE, enter the test duration, then press ENTER. The system displays your choice:

**DURATION: (Time)
PRESS <STEP> TO CONTINUE**

Press STEP to confirm your choice. The system displays the message:

**START LEAK TEST: ALL TANKS
PRESS <ENTER>**

Press ENTER to confirm that you want to run the leak test on all tanks. The system displays the message:

**START IN-TANK LEAK TEST
PRESS <STEP> TO CONTINUE**

and prints a report confirming that a test has started on all tanks. Press STEP to continue. The system confirms that the test has started:

**TEST CONTROL: ALL TANKS
LEAK TEST IN PROGRESS**

Testing All Tanks Using Manual Control

NOTE: If you start an In-Tank Leak Test manually, you will need to stop the test manually. Otherwise, the test will run for 24 hours.

To manually start an In-Tank Leak Test for all tanks, press FUNCTION until you display the message:

**START IN-TANK LEAK TEST
PRESS <STEP> TO CONTINUE**

Press STEP to display the message:

**START LEAK TEST METHOD
ALL TANK**

Press STEP. The system displays the message:

**TEST CONTROL: ALL TANK
TIMED DURATION**

Press CHANGE. The system displays the message:

**TEST CONTROL: ALL TANK
MANUAL STOP**

Press ENTER. The system displays the message:

**MANUAL STOP
PRESS <STEP> TO CONTINUE**

Press STEP. The system displays the message:

**TEST CONTROL: ALL TANK
0.20 GAL/HR**

Press STEP to run a 0.2 gph (0.76 lph) test, or CHANGE to run a 0.1 gph (0.38 lph) test (only available with 0.1 Mag probes). Press ENTER to confirm that you want to run the 0.1 gph leak test. The system displays the message:

**0.10 GAL/HR
PRESS <STEP> TO CONTINUE**

Press STEP. The system displays the message:

**START LEAK TEST: ALL TANK
PRESS <ENTER>**

Press ENTER. The system starts the test and prints a report indicating that the test has started. Press FUNCTION to exit.

Testing Single Tanks for a Timed Duration

To perform an In-Tank Leak Test for a specific tank, press FUNCTION until you display the message:

**START IN-TANK LEAK TEST
PRESS <STEP> TO CONTINUE**

Press STEP to display the message:

**START LEAK TEST METHOD
ALL TANKS**

Press CHANGE, then press ENTER. The system displays the message:

**SINGLE TANK
PRESS <STEP> TO CONTINUE**

Press STEP. The system displays the message:

**TEST CONTROL: TANK #
TIMED DURATION**

Press STEP to confirm that you want to run the test for a timed duration.

OR

Press TANK/SENSOR to select a different tank, then press STEP. The system displays the message:

**TEST CONTROL: TANK #
0.20 GAL/HR**

If you want to run a 0.2 gph (0.76 lph) test, press STEP. If you want to run a 0.1 gph (0.38 lph) test (only available with 0.1 Mag probes), press CHANGE, then press ENTER. The system displays the message:

**0.10 GAL/HR
PRESS <STEP> TO CONTINUE**

Press STEP. The system displays the message:

**TEST DURATION: TANK #
DURATION: XX**

If you want to change the duration of the test (the length of time the test will run in hours), press CHANGE, enter the test duration, then press ENTER. The system displays your choice:

**DURATION: (Time)
PRESS <STEP> TO CONTINUE**

Press STEP. The system displays the message:

**START LEAK TEST: TANK #
PRESS <ENTER>**

Press ENTER to confirm that you want to run the leak test on the selected tank. The system confirms that the test has started:

TEST CONTROL: TANK #
TIMED DURATION

If you need to run the leak test on additional tanks, press TANK/SENSOR. To exit, press FUNCTION.

Testing Single Tanks using Manual Control

If you start an In-Tank Leak Test manually, you will need to stop the test manually. Otherwise, the test will run for 24 hours.

To perform an In-Tank Leak Test for single tanks under manual control, press FUNCTION until you display the message:

START IN-TANK LEAK TEST
PRESS <STEP> TO CONTINUE

Press STEP to display the message:

START LEAK TEST METHOD
ALL TANKS

Press CHANGE, then press ENTER. The system displays the message:

SINGLE TANK
PRESS <STEP> TO CONTINUE

Press STEP to continue. The system displays the message:

TEST CONTROL: TANK #
TIMED DURATION

Press CHANGE, then press ENTER. The system displays the message:

MANUAL STOP
PRESS <STEP> TO CONTINUE

Press STEP. The system displays the message:

TEST CONTROL: TANK #
0.20 GAL/HR

If you want to run a 0.1 gph (0.38 lph) test (only available with 0.1 Mag probes). Press CHANGE. Press STEP to continue. The system displays the message:

START LEAK TEST: TANK #
PRESS <ENTER>

Press ENTER to confirm that you want to run the leak test on the selected tank. The system will automatically advance to the next tank, displaying the TEST CONTROL: TANK (#) message. You can begin a test on the next tank by repeating this procedure, or press FUNCTION to exit.

Test Results

At the end of the test, the system reports the test results:

PASSED - Volume change (if any) was less than the threshold for the selected test.

FAILED - Volume change was greater than the threshold for the selected test and all test conditions were acceptable.

INVALID - One or more test conditions was outside an acceptable range. The tank number, product label and unacceptable condition(s) print after the leak rate report.

The report will then show, by tank, any conditions that occurred during the test that may have affected the test results. Refer to Table 29-3 or Table 29-4 in the "Troubleshooting" section for a possible causes of Invalid or Failed results.

21 How To Stop In-Tank Leak Tests

This section describes how to stop In-tank Leak Tests.

All Tanks

To stop an In-Tank Leak Test for all tanks, press FUNCTION until you display the message:

**STOP IN-TANK LEAK TEST
PRESS <STEP> TO CONTINUE**

Press STEP to display the message:

**STOP LEAK TEST METHOD
ALL TANKS**

To discontinue the tests for ALL TANKS, press STEP. The system displays the message:

**STOP LEAK TEST: ALL TANKS
PRESS <ENTER>**

Press ENTER to confirm that you want to stop the leak test on all tanks. The system confirms that the test has stopped:

**LEAK TEST NOT ACTIVE
PRESS <FUNCTION> TO CONTINUE**

Press FUNCTION to exit.

Single Tank

To stop an In-Tank Leak Test for a specific tank, press FUNCTION until you display the message:

**STOP IN-TANK LEAK TEST
PRESS <STEP> TO CONTINUE**

Press STEP to display the message:

**STOP LEAK TEST METHOD
ALL TANKS**

Press CHANGE, then press ENTER. The system displays the message:

**SINGLE TANKS
PRESS <STEP> TO CONTINUE**

Press STEP. The system displays the message:

**STOP LEAK TEST: TANK #
PRESS <ENTER>**

Press TANK to select the tank you want to stop the test on. **Be sure you have selected the correct tank**, then press ENTER. The system stops the test on the selected tank and displays the message:

STOP LEAK TEST: TANK #
LEAK TEST NOT ACTIVE

To advance to the next tank, press TANK/SENSOR. Continue until you have stopped all the tests you want to discontinue. If all active tests are stopped, the system displays the message:

LEAK TEST NOT ACTIVE
PRESS <FUNCTION> TO CONTINUE

Press FUNCTION to exit.

22 Test Output Relays

This function activates relay and input/output devices, energizing the selected relays. You can use this function to control external devices such as external alarms or pump contactors.

To select this function, press FUNCTION until you display the message:

```
TEST OUTPUT RELAYS  
PRESS <STEP> TO CONTINUE
```

Press STEP. The system displays the message:

```
TEST OUTPUT RELAYS  
ENTER RELAY NUMBER #
```

Enter the number of the relay you want to test, then press ENTER. The system displays the number and name of the relay you selected. For example:

```
R 1: OVERFILL ALARM  
PUSH ALARM/TEST KEY
```

Press the ALARM/TEST key. The system displays the message:

```
R 1: (Device Name)  
ON - PRESS ANY KEY
```

Press any key to continue. The system displays the message:

```
TEST OUTPUT RELAYS  
ENTER RELAY NUMBER #
```

Repeat this procedure for any additional relays, or press FUNCTION to exit.

23 Mag Sump Sensor Leak Test Results

Press FUNCTION until you display the message:

```
MAG SUMP LK TEST RESULTS
PRESS <STEP> TO CONTINUE
```

This menu displays only if the console detects a Mag Sump Sensor capable of leak detection

Press STEP to display the message:

```
s 1: 2-19-05      9:43AM
LAST PASSED TEST
```

Press PRINT to printout the last passed Mag Sump Sensor leak test results:

MAG SUMP LEAK TEST LAST PASSED TEST	Test passed.
MMM DD, YYYY HH:MM XM	
s 1: SUMP 1	
RESULT: TEST PASSED	
START TIME: MMM DD, YYYY HH:MM XM	Start time of measuring height phase.
START HT: 22.971 IN	
START TEMP: 76.1 F	
END HT: 22.969 IN	
END TEMP: 76.1 F	
DURATION: 120 MINS	

Press STEP to display the message:

```
s 1: SUMP 1
PRESS PRINT FOR HISTORY
```

23 Mag Sump Sensor Leak Test Results

Press PRINT to printout the leak test history for this sensor. The example printout below shows the last test results and the last passed test for each year, up to the last 10 years (if applicable):

```
MAG SUMP LEAK TEST HISTORY
MMM DD, YYYY  HH:MM XM
s 1: SUMP 1

LAST 10 TESTS PASSED:
START TIME:
FEB 19, 2005  9:43 AM
START HT:      22.971 IN

START TIME:
FEB 11, 2005  10:15 AM
START HT:      20.005 IN

START TIME:
DEC 22, 2004  2:45 PM
START HT:      20.350 IN
:
:
LAST PASSED EACH YEAR:
START TIME:
FEB 19, 2005  9:43 AM
START HT:      20.350 IN

START TIME:
DEC 22, 2004  2:45 PM
START HT:      20.350 IN
:
:
```

Start time of measuring height phase.

Last 10 Years.

24 Start Mag Sump Sensor Leak Test

Mag Sump Sensor Leak Test

Prior to starting a Mag Sump Test:

- Replace lid on sump to be tested
- Turn off STP if in sump to be tested
- Replace cabinet access cover if testing a dispenser pan/sump

There are two phases to a Mag Sump Leak Test.

- **Test Phase** - After replacing the sump lid and disabling the STP, a user will start a Mag Sump Leak Test which starts the Test Phase. The TLS will automatically print that the Test Phase was started. During the Test Phase water alarms/warnings are suppressed so that the user can fill the sump with water. Fuel alarms/warnings are not suppressed. Any water alarms/warnings that are active when the Test Phase is started will be cleared. If after 2 hours the user has not started the Measuring Height Phase then the test will be aborted.
- **Measuring Height Phase** - Once water is added to the sump the user will start the Mag Sump Leak Test Measuring Height Phase. The TLS will automatically print that the Measuring Height Phase was started. During the Measuring Height Phase the TLS will wait for the water temperature to stabilize. Once the temperature is stable a leak rate will be calculated. If after 2 or more hours the leak rate is less than 0.0104 inches (0.264 mm) per hour (0.25 inches [6.35 mm]/24 hrs) then the test automatically passes. The test will be aborted if at any time the water height is 0.25 inches less than the water height at the start of the Measuring Height Phase.

The Mag Sensor will continue to suppress water alarms/warnings not fuel alarms during Measuring Height Phase.

At any time during the test the water height is greater than the sensor length minus 2 inches, then the water/fluid alarms/warnings are no longer suppressed. The sensor is in a position where it cannot detect fuel (the floats are against the stop).

After the leak test has been completed (passed/aborted) the water alarms/warnings will still be suppressed for 24 hours to allow time to empty water out of the sump. If the water is emptied in less than 24 hours then the water alarm/warnings will no longer be suppressed. The sump is considered to be empty if there is no water detected for 5 consecutive minutes.

The TLS will automatically printout the test result when the test has been completed.

MAG SUMP LEAK TEST ABORT CONDITIONS

There must be no active Mag Sump alarms/warnings except for water alarms/warnings when the Mag Sump Leak Test Phase is started and while it is running or the test will be aborted:

The following conditions must exist when the Mag Sump Leak Test Measuring Height Phase is started and while it is running or the test will be aborted:

- There is at least 6 inches of water in sump, but not more than a depth equal to the sensor's length, minus 2 inches.
- The sump's water temperature must be between 36 °F and 115 °F (2.2 °C and 46.1 °C).
- The sump's water height is 0.25 inches less than the water height (single reading) at the start of the Measuring Height Phase.
- The sump's water height is 0.10 inches (2.54 mm) more than the water height (single reading) at the start of the Measuring Height Phase.
- The temperature must be stable within 4 hours.

STOPPING A MAG SUMP LEAK TEST

A leak test will either pass or be aborted, it will not fail. A leak test can be stopped in one of three ways:

1. Test automatically passes.
2. The TLS aborts the test.
3. The user manually aborts the test.

TEMPERATURE STABILITY

After the Measuring Height Phase has been started, the average water temperature of two 5 minute periods are compared to determine if the temperature is stable or not. If the difference between the two periods is less than 5 degrees F/hour, then the temperature is considered stable. If the temperature is not stable then every 5 minutes the average water temperature of the last two 5 minute periods are used to determine if the temperature is stable. This will continue until the temperature is considered stable. The test will be aborted if the temperature has not stabilized in 4 hours.

LEAK RATE CALCULATION

Once the temperature is considered stable a leak rate will be calculated as follows. After 2 hours the leak rate is calculated from the last 2 hours of data and compared to the leak rate threshold of 0.0104 inches (0.264 mm) per hour. If the calculated leak rate is less than the leak rate threshold then the test passes, otherwise it continues. At every half hour until the test passes, or until 24 hours, it recalculates the leak rate using the last 2 hours data and compares this value to the leak rate threshold. If after 24 hours the water height has not dropped 0.25 inches or more, then the test will pass even if the calculated leak rate is greater than or equal to the leak rate threshold. The test will be aborted if the water height (not TC height) is 0.25 inches (6.35 mm) less than the water height (single reading) at the start of the Measuring Height Phase.

MAG SUMP LEAK TEST STATUS MESSAGES

There are several status messages that will appear during or after the test completes or is aborted:

- NO TEST DATA AVAILABLE
- STATUS:FILL SUMP
- STATUS:MEASURING HEIGHT
- TEST PASSED
- ABORT: (for list of causative messages - see below):
 - MAG SENS ALM/WARN (other than water/fluid alarm or warning)
 - WATER TOO LOW (sump water depth less than 6" [153 mm])
 - WATER TOO HIGH (sump water depth more than 22 inches (558 mm) for a 24-inch sensor, or 10 inches (304 mm) for a 12-inch sensor.
 - TEMP TOO LOW (water temp less than 36 °F [2.2 °C])
 - TEMP TOO HIGH (water temp higher than 115 °F [46.1 °C])
 - WATER DECREASED (more than 0.25" [6.35 mm])
 - WATER INCREASED (more than 0.1" [2.54 mm])
 - INSUFFICIENT DATA (test manually aborted before 2 hrs)
 - LEAK RATE TOO HIGH (leak rate was greater than or equal to than 0.0104 inches (0.264 mm) per hour, and test was manually aborted after 2 hrs)
 - TEST PHASE TIMEOUT (Measuring Height Phase not started within 2 hours)
 - TMP STABLE TIMEOUT (temperature didn't stabilize within 4 hours)

Starting a Leak Test

Press FUNCTION until you display the message:

```
MAG SUMP LEAK TEST
PRESS <STEP> TO CONTINUE
```

This menu displays only if the console detects a Mag Sump Sensor capable of leak detection

Press STEP to the message below:

```
s 1: SUMP 1
0.000 IN      74.8 F
```

Current height and temperature in sump

Press STEP:

```
s 1: TEMP RATE: UNKNOWN
LEAK RATE: UNKNOWN
```

This menu is displayed when not in the measuring height phase
Press PRINT to printout Mag Sump Leak Test

OR

```
s 1: TEMP RATE: COMPUTING
LEAK RATE: COMPUTING
```

This menu is displayed when in the first 10 minutes of measuring height phase
Press PRINT to printout Mag Sump Leak Test in progress

OR

```
s 1: TEMP RATE: 6.1 F/HR
LEAK RATE: 0.0123 IN./HR
```

Displayed after 10 minutes of the measuring height phase and temp not stable
Press PRINT to printout Mag Sump Leak Test in progress

OR

```
s 1: TMP STABLE: 115 MINS
LEAK RATE: 0.0123 IN./HR
```

Displayed after 10 minutes of the measuring height phase and temp is stable
Press PRINT to printout Mag Sump Leak Test in progress

Press STEP:

```
s 1: SUMP 1
NO TEST DATA AVAILIABLE
```

This menu is displayed when no tests have been run.
Press PRINT to printout Mag Sump Leak Test (no test data available)

OR

```
s 1: 3-29-05 9:43AM
TEST PASSED
```

Date/Time of start of measuring height phase
Press PRINT to printout Mag Sump Leak Test Last Test (test passed)

OR

```
s 1: 3-29-05 9:43AM
ABORT: WATER TOO LOW
```

Date/Time of start of test phase or measuring height phase
Press PRINT to printout Mag Sump Leak Test Last Test (test aborted)

OR

```
s 1: 3-29-05 9:43AM
STATUS: FILL SUMP
```

Date/Time of start of test phase
Press PRINT to printout Mag Sump Leak Test in progress

OR

```
s 1: 3-29-05 9:43AM
STATUS: CHK TEMP STABLE
```

Date/Time of start of measuring height phase
Press PRINT to printout Mag Sump Leak Test in progress

OR

```
s 1: 3-29-05 9:43AM
STATUS: MEASURING HEIGHT
```

Date/Time of start of measuring height phase
Press PRINT to printout Mag Sump Leak Test in progress

Press STEP:

s 1: 3-29-05 9:43AM
STATUS: MEASURING HEIGHT

Press STEP to begin leak test:

START MAG SUMP LEAK TEST
PRESS <ENTER>

Press ENTER:

SELECT MAG SENSOR
ALL MAG SENSORS

Press ENTER to test all sensors, or press CHANGE until the desired sensor is displayed:

SELECT MAG SENSOR
s1: (MAG SENSOR LABEL)

Press ENTER to confirm selection:

START LEAK TEST: s 1
PRESS <ENTER>

Press ENTER to begin test:

s 1:FILL SUMP
PRESS <STEP> TO CONTINUE

Fill sump with the correct depth of water. NOTE: the correct depth of water in the sump for this test must be between 6 and 22 inches (153 - 558 mm) for a 24-inch sensor, and 6 and 10 inches (153 - 304 mm) for a 12-inch sensor. Press STEP to continue.

START MEASURING HEIGHT
PRESS <ENTER>

Press ENTER:

SELECT MAG SENSOR
ALL MAG SENSORS

Press CHANGE until the desired sensor is displayed (in this example, s1):

SELECT MAG SENSOR
s1: (MAG SENSOR LABEL)

Press ENTER to confirm selection.:

START MEASURING HT: s 1
PRESS <ENTER>

Press ENTER to start measuring phase:

```
s 1:MEASURING HEIGHT
PRESS <STEP> TO CONTINUE
```

The test can take from 2 - 24 hours to complete.

Stopping a Leak Test

Press FUNCTION until you display the message:

```
MAG SUMP LEAK TEST
PRESS <STEP> TO CONTINUE
```

Press STEP to the message below:

```
s 1: SUMP 1
7.678 IN      70.1 F
```

Press STEP:

```
s 1: 3-29-05      9:43AM
STATUS: MEASURING HEIGHT
```

Press PRINT to printout the status of the current test, if in progress, or the last completed test. Figure 24-1 shows an example printout of a test in progress and Figure 24-2 shows an example printout of an aborted test.

```

MAG SUMP LEAK TEST
IN PROGRESS
-----

FEB 21, 2005  10:00 AM
S 1: SUMP 1

STATUS:MEASURING HEIGHT
START TIME:
  FEB 19, 2005  9:43 AM
START HT:      20.971 IN.
START TEMP:    76.1 F
CURRENT HT:    20.971 IN.
CURRENT TEMP:  76.1 F
DURATION:      17 MINS
TEMP RATE:     6.1 F/HR
LEAK RATE:     0.0000 IN./HR
  
```

Start time of measuring height phase

consoles\magsumprept4.eps

Figure 24-1. Example printout of leak test in progress - Measuring Height Phase

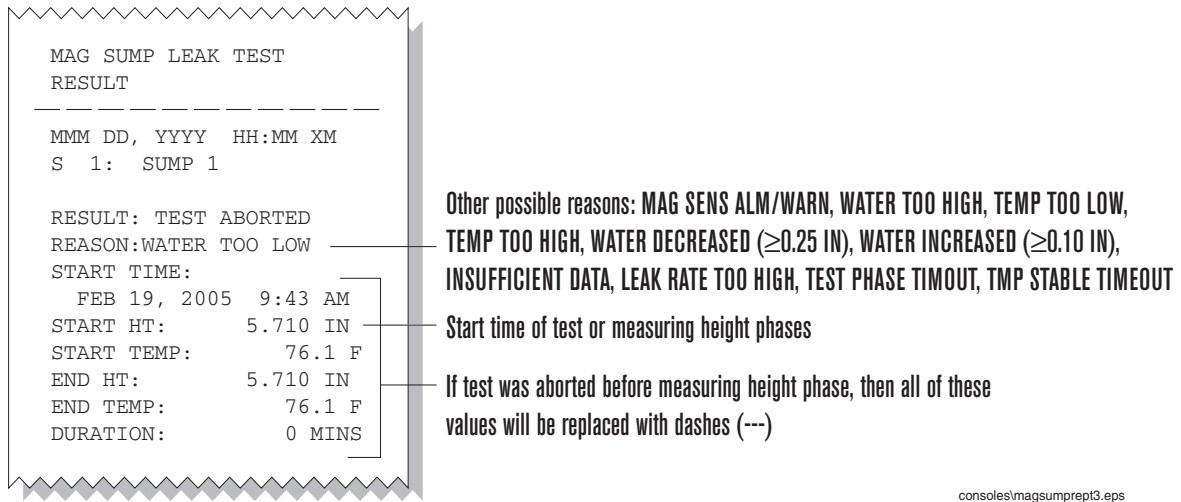

Figure 24-2. Example printout of an aborted test

Press STEP:

```

START MAG SUMP LEAK TEST
PRESS <ENTER>
  
```

Press STEP:

```

START MEASURING HEIGHT
PRESS <ENTER>
  
```

Press STEP:

```

STOP MAG SUMP LEAK TEST
PRESS <ENTER>
  
```

Press ENTER:

```

SELECT MAG SENSOR
ALL MAG SENSORS
  
```

Press CHANGE until the desired sensor is displayed (in this example, s1):

```

SELECT MAG SENSOR
s1: (MAG SENSOR LABEL)
  
```

Press ENTER to confirm selection.:

```

STOP LEAK TEST: s 1
PRESS <ENTER>
  
```

Press ENTER:

```

s 1: TEST ABORTED
PRESS <STEP> TO CONTINUE
  
```

25 Smart Sensor Status

Smart sensor status reports the status of the smart sensors connected to the Smart Sensor / Press Module and indicates if an alarm condition exists. To select smart sensor status, press FUNCTION until you display the message:

```
SMART SENSOR STATUS
PRESS <STEP> TO CONTINUE
```

To print a complete smart sensor status report, press PRINT. A sample report is shown below:

```
SMART SENSOR STATUS
-----
MMM DD, YYYY HH:MM XM

s1: SUMP 1
SENSOR NORMAL
```

To view the smart sensor status for a particular sensor, press STEP to display the message:

```
s#: (Location)
(Status Indicator)
```

If the sensor is functioning properly and no alarm conditions exist, the system displays the message SENSOR NORMAL. If the sensor is not functioning normally or an alarm condition exists, the system displays a message about the status of the sensor. See the "Troubleshooting" Section, Table 29-5 and following for Smart Status sensor messages.

To view the smart sensor status for other sensors in the system, press TANK/SENSOR. To generate a smart status report for the selected sensor, press PRINT.

26 VMC Status Reports

Vapor Monitor Controller (VMC) Status reports the status of the vmc controllers connected to the Vapor Controller Monitor interface module and indicates if an alarm condition exists. To select VMC status, press FUNCTION until you display the message:

```
VMC REPORT
PRESS <STEP> TO CONTINUE
```

To print a complete VMC Report, press PRINT. You can generate a report for up to 18 VMC controllers. A sample report is shown below:

```
MMM DD, YYYY HH:MM XM
VMC REPORT
-----
x 1: 005830 SIDE A
STATUS: IDLE
RECOVER RATE: 100.9
FUEL COUNTER: 0
ERROR COUNTER: 0
REMAIN TIME: 0

x 1: 005830 SIDE B
STATUS: IDLE
RECOVER RATE: 101.2
FUEL COUNTER: 26
ERROR COUNTER: 0
REMAIN TIME: 0
```

← See the "Troubleshooting" Section, Table 29-23 for a complete list of VMC Status messages.>

Press STEP to continue.

```
x #: (S/N)
PRESS <ENTER>
```

Press ENTER:.

```
x #: (S/N) SIDE A
STATUS: IDLE
```

Press Step to view the next Side A value for this controller or press TANK/SENSOR to select another VMC controller.

27 Diagnostic Mode

In the Diagnostic Mode, you can print various test and historical reports, including diagnostic reports for the Fuel Management option. Additional functions in this mode, which are used primarily by trained service personnel to analyze system performance, are not discussed in this manual.

To access the Diagnostic Mode, press MODE until you display the message:

```
DIAG MODE
PRESS <FUNCTION> TO CONTINUE
```

The functions that will be discussed in this section include:

- Service Report
- In-Tank Leak Test Results
- CSLD Monthly Report
- Alarm History Report
- Fuel Management Diagnostic Report

Service Report

To print a Service Report, press FUNCTION until you display the message:

```
SERVICE REPORT
PRESS <STEP> TO CONTINUE
```

To printout a list of the 25 most recent service codes entered, Press PRINT.

In-Tank Leak Test Results

To access the In-Tank Leak Test Results, press FUNCTION until you display the message:

```
IN-TANK LEAK RESULT
PRESS <STEP> TO CONTINUE
```

To print a complete In-Tank Leak Test Results report for each tank in the system, press PRINT.

0.2 GPH (0.76 LPH) LEAK TEST RESULTS

To print 0.2 gph leak test results for a specific tank, press STEP to display the message:

```
T#: (Product Label)
PRINT 0.20 LEAK REPORT
```

Press PRINT. To view 0.2 gph Leak Test Results for other tanks in the system, press TANK.

0.1 GPH (0.38 LPH) LEAK TEST RESULTS

To view 0.1 gph leak test results for a specific tank, press STEP until you display the message:

T#: (Product Label)
PRINT 0.10 LEAK REPORT

Press TANK to view 0.1 gph Leak Test Results for other tanks in the system.

LAST TEST DATE AND TIME

To view the Test Date and Time of the last test for a specific tank, press STEP until you display the message:

T#: (Product Label)
(Last Test Date & Time)

Press TANK. To view the last test date and time for other tanks in the system, press TANK.

LEAK RATE

The Leak Rate is the amount of product leaking per hour. To view the Leak Rate for a specific tank, press STEP until you display the message:

T#: (Product Label)
LEAK RATE: X.XX (Unit)/HR

Press TANK to view the leak rate for other tanks in the system.

PRINT LEAK HISTORY

To print a full leak history for a specific tank, press STEP until you display the message:

T#: (Product Label)
PRINT LEAK HISTORY

To print the report, press PRINT. To print the leak history for other tanks in the system, press TANK. To exit the In-Tank Leak Result function, press FUNCTION.

CSLD Monthly Report

The CSLD Monthly Report lists all status changes for the current or previous month. Status changes include; No Results, Pass, Fail, Increase & Warn and Dispense State, Status 'No Idle Time', and ACTIVE. There are a maximum of 10 status changes per month. To access the CSLD Monthly Report, you must have the CSLD option. Press FUNCTION until you display the message:

```
CSLD DIAGNOSTICS
PRESS <STEP> TO CONTINUE
```

Press STEP until you see the message:

```
CSLD MONTHLY REPORT
PRESS <ENTER>
```

Press ENTER and the following message appears:

```
CSLD MONTHLY REPORT
SELECT: CURRENT MONTH
```

Press STEP and the message displays: OR –

```
T #: (Product Label)
CUR CLSD MONTHLY <PRINT>
```

Press PRINT to print out the report for the tank shown. Press TANK/SENSOR to access another tank's report.

Press CHANGE, then ENTER to access the previous month's report:

```
SELECT: PREVIOUS MONTH
PRESS <STEP> TO CONTINUE
```

Press STEP and the message displays:

```
T #: (Product Label)
PRV CLSD MONTHLY <PRINT>
```

Press PRINT to print out the report for the tank shown. Press TANK/SENSOR to access another tank's report.

Press MODE to exit the Diagnostic Mode.

Alarm History Reports

Alarm History Reports are available on the console's printer or through the RS-232 interface. They provide a record of the last three occurrences of **each type** of alarm or warning condition.

Alarm histories are kept for the system and for each in-tank probe, sensor and input device connected to the system.

You can display in-tank, sensor and external input alarm histories by tank, sensor or input number by pressing the TANK/SENSOR key.

For a description of Alarm Messages, see the Troubleshooting section of this manual.

SYSTEM ALARM HISTORY REPORT

System Alarm History Reports record system related alarms such as, Setup Data Warning, Paper Out, etc. Press MODE to select Diagnostic Mode. Press FUNCTION until you display the message:

**ALARM HISTORY REPORT
PRESS <STEP> TO CONTINUE**

Press STEP to continue. The system displays the message:

**SYSTEM ALARM HISTORY
PRESS <PRINT> FOR REPORT**

Press PRINT. The system generates the report.

IN-TANK ALARM HISTORY REPORT

In-Tank Alarm History Reports record alarms for the tank selected. To print an In-Tank Alarm History Report, press STEP until you display the message:

**T#: ALARM HISTORY
PRESS <PRINT> FOR REPORT**

Press PRINT to print the report for the tank displayed. Press TANK/SENSOR to access other tanks in the system.

LIQUID SENSOR ALARM HISTORY REPORT

Liquid Sensor Alarm History Reports record alarms for the liquid sensor selected. To print a Liquid Sensor Alarm History Report, press STEP until you display the message:

**L#: ALARM HISTORY
PRESS <PRINT> FOR REPORT**

Press PRINT to print the report. Press TANK/SENSOR to access other liquid sensors in the system.

VAPOR SENSOR ALARM HISTORY REPORT

Vapor Sensor Alarm History Reports record alarms for the vapor sensor selected. To print a Vapor Sensor Alarm History Report, press STEP until you display the message:

**V#: ALARM HISTORY
PRESS <PRINT> FOR REPORT**

To print the report, press PRINT. To select other vapor sensors, press TANK/SENSOR.

EXTERNAL INPUT ALARM HISTORY REPORT

External Input Alarm History Reports record alarms for the external input selected. To print an External Input Alarm History Report, press STEP until you display the message:

**I#: ALARM HISTORY
PRESS <PRINT> FOR REPORT**

To print the report, press PRINT. To access other external inputs in the system, press TANK/SENSOR.

VOLUMETRIC LINE LEAK ALARM HISTORY REPORT (TLS-350 PLUS/TLS-350R ONLY)

Volumetric Line Leak Alarm History Reports record alarms for the VLLD line selected. To print a Volumetric Line Leak Alarm History Report, press STEP until you display the message:

**P#: ALARM HISTORY
PRESS <PRINT> FOR REPORT**

Press PRINT to print the report. To select a different line, press TANK/SENSOR.

GROUNDWATER ALARM HISTORY REPORT

Groundwater Alarm History Reports record alarms for the groundwater sensor. To print a Groundwater Alarm History Report, press STEP until you display the message:

**G#: ALARM HISTORY
PRESS <PRINT> FOR REPORT**

To print the report, press PRINT. To access other groundwater sensors in the system, press TANK/SENSOR.

2-WIRE C.L. (TYPE A SENSORS) ALARM HISTORY REPORT

2-Wire C.L. Alarm History Reports record alarms for Discriminating Interstitial Sensors. To print a 2-Wire Current Loop Alarm History Report, press STEP until you display the message:

**C#: ALARM HISTORY
PRESS <PRINT> FOR REPORT**

To print the report, press PRINT. To select other sensors in the system, press TANK/SENSOR.

OTHER SENSORS ALARM HISTORY REPORT

Other Sensors Alarm History Reports record alarms for the sensor selected. To print an Other Sensors Alarm History Report, press STEP until you display the message:

**g#: ALARM HISTORY
PRESS <PRINT> FOR REPORT**

To print the report, press PRINT. To select other sensors, press TANK/SENSOR.

3-WIRE C.L. (TYPE B SENSORS) ALARM HISTORY REPORT

3-Wire C.L. History Reports record alarms for the sensor selected. To print a 3-Wire C.L. Alarm History Report, press STEP until you display the message:

**H#: ALARM HISTORY
PRESS <PRINT> FOR REPORT**

To print the report, press PRINT. Press TANK/SENSOR to select other 3-Wire C.L. Sensors.

PRESSURE LINE LEAK (PLLD) ALARM HISTORY REPORT

Pressure Line Leak History Reports record the alarms for the line selected. To print a PLLD Alarm History Report, press STEP until you display the message:

**Q#: ALARM HISTORY
PRESS <PRINT> FOR REPORT**

To print the report, press PRINT. To select a different line, press TANK/SENSOR.

WIRELESS PRESSURE LINE LEAK (WPLLD) ALARM HISTORY REPORT

Wireless Pressure Line Leak History Reports record the alarms for the line selected. To print a WPLLD Alarm History Report, press STEP until you display the message:

**W#: ALARM HISTORY
PRESS <PRINT> FOR REPORT**

To print the report, press PRINT. To select a different line, press TANK/SENSOR.

To exit this function, press FUNCTION.

SMART SENSOR ALARM HISTORY REPORT

Smart Sensor History Reports record the alarms for the line selected. To print a Smart Sensor Alarm History Report, press STEP until you display the message:

**s#: ALARM HISTORY
PRESS <PRINT> FOR REPORT**

To print the report, press PRINT. To select a different Smart Sensor, press TANK/SENSOR.

To exit this function, press FUNCTION.

PUMP RELAY MONITOR ALARM HISTORY REPORT

Pump Relay Monitor History Reports record the alarms for the relay selected. To print a Pump Relay Monitor Alarm History Report, press STEP until you display the message:

**r#: ALARM HISTORY
PRESS <PRINT> FOR REPORT**

To print the report, press PRINT. To select a different relay, press TANK/SENSOR.

To exit this function, press FUNCTION.

VMCI INTERFACE MODULE ALARM HISTORY REPORT

VMCI History Reports record the alarms for the VMCI interface module. To print a VMCI Alarm History Report, press STEP until you display the message:

**X1: ALARM HISTORY
PRESS <PRINT> FOR REPORT**

To print the report, press PRINT. To exit this function, press FUNCTION.

VMC CONTROLLER ALARM HISTORY REPORT

VMC ControllerHistory Reports record the alarms for the VMC selected. To print a VMC Alarm History Report, press STEP until you display the message:

**x#: ALARM HISTORY
PRESS <PRINT> FOR REPORT**

To print the report, press PRINT. To select a different VMC, press TANK/SENSOR.

To exit this function, press FUNCTION.

Fuel Management Diagnostics

The Fuel Management reports listed below are of primary interest to station owners or managers:

- Days of fuel remaining.
- Current inventory.
- 95% ullage.
- Average sales figure for a particular day.
- Last sales figure for a particular day.
- Predicted sales figure for a particular day.

To access the Fuel Management Diagnostic you must have the Fuel Management Option. Press FUNCTION until you display the message:

**FUEL MANAGEMENT DIAG
PRESS <STEP> TO CONTINUE**

Press PRINT to print a daily fuel management diagnostics report for all products. For example:

```

MMM DD, YYY HH:MM XM
FUEL MANAGEMENT DIAG
-----
T1: REGULAR UNLEADED
T2: REG UNLEADED TANK 2

DAYS FUEL REMAINING:2.4
INVENTORY:          2453 GAL

95% ULLAGE          7037 GAL

          AVG  LAST  PRED
SUN:     983  1045  1008
MON:    1243  1185  1205
TUE:    1007  1023  1014
WED:    1129  1191  1157
THR:    1095  1076  1085

```

MMM DD, YY	HH:MM	XM
FRI: 1362	1350	1355
SAT: 1043	1090	1069

AVERAGE SALES

Average Sales displays the average sales figure for the product and day selected. To view the Average Sales for a product, press STEP until you display the message:

(Product Name) AVG SALES-SUN: XXXX GAL

To view the next product selection, press TANK. The product name displayed is the lowest tank number with the product. Press STEP to continue to select average daily sales, last sales, and predicted sales for other days of the week. Press PRINT at any time to print a Fuel Management Diagnostics Report for the selected product.

LAST SALES

Last Sales displays the last sales figure for the product and day selected.

To view the Last Sales for a product, press STEP until you display the message:

(Product Name) LAST SALES-SUN: XXXX GAL
--

To view a different product, press TANK. Press STEP to continue to select average daily sales, last sales, and predicted sales for other days of the week. Press PRINT at any time to print a Fuel Management Diagnostics Report for the selected product.

PREDICTED SALES

Predicted Sales displays the predicted sales figure for the product and day selected. To view the Predicted Daily Sales for a product, press STEP until you display the message:

(Product Name) PRED SALES-SUN: XXXX GAL
--

To view the next product selection, press TANK. Press STEP to continue to select average daily sales, last sales, and predicted sales for other days of the week. Press PRINT at any time to print a Fuel Management Diagnostics Report.

28 Reconciliation Mode

The Reconciliation Mode reconciles the totals at the end of each shift, day, and period, eliminating the need to manually collect and reconcile the fuel inventory.

Note: Business Inventory Reconciliation is an option. You must have the **BIR** software module key installed to access this mode.

To enter the Reconciliation Mode, press MODE until you display the message:

```
RECONCILIATION MODE
PRESS <FUNCTION> TO CONTINUE
```

These functions are available in Reconciliation Mode:

- Manual Shift Close
- Variance Reports
- Reconciliation Reports
- Manual Adjustments

Manual Shift Close

Manual Shift lets you close the shift and generate a Shift Reconciliation Report. This report includes:

- Opening date and time
- Opening volume
- Metered sales
- System calculated inventory at shift close
- Water height
- Closing date and time
- Deliveries
- Any manual adjustments made during the shift
- The gauged inventory on hand
- Any variance in the calculated inventory and the gauged inventory

To access Manual Shift Close, press FUNCTION until you display the message:

```
MANUAL SHIFT CLOSE
PRESS <STEP> TO CONTINUE
```

Press STEP to display the message:

```
MANUAL SHIFT CLOSE
SHIFT CLOSE NOW: NO
```

To print a Shift Reconciliation Report for the previous shift, press PRINT. To close out the current shift, press CHANGE. The system displays the message:

```
MANUAL SHIFT CLOSE
SHIFT CLOSE NOW: YES
```

Press ENTER. To print a Shift Reconciliation Report for the shift ending now, press PRINT. For example:

```

MMM DD, YYYY HH:MM XM

SHIFT RECONCILIATION
-----
T 1: (Product Label)

OPENING DATE & TIME:
MMM DD, YYYY HH:MM XM

CLOSING DATE & TIME:
MMM DD, YYYY HH:MM XM

OPENING VOLUME:
                    5511 GALS
DELIVERIES:
                    0 GALS
METERED SALES:
                    300 GALS
MANUAL ADJUSTMENTS:
                    0 GALS
CALCULATED INVNTY:
                    5211 GALS
GAUGED INVNTY:
                    5211 GALS
WATER HEIGHT:
                    2.10 INCH
VARIANCE:
                    0 GALS

```

Reconciliation Reports

Reconciliation Reports let you generate:

- Complete Shift Reports for all products and shifts
- A report for the selected product
- A report for the selected shift

Note: Reconciliation Reports are generated as a single product report for a manifolded set.

ALL PRODUCTS AND ALL SHIFTS

To print Reconciliation Report information for all products and all shifts, press FUNCTION until you display the message:

**DISPLAY AND PRINT
PRESS <STEP> TO CONTINUE**

Press STEP to continue. The system displays the message:

**DISPLAY AND PRINT
REPORT TYPE: SHIFT**

Press PRINT.

DAILY

All Products--To print a daily report for all products, press CHANGE, then press PRINT in response to the message:

DISPLAY AND PRINT
REPORT TYPE: SHIFT

The system displays the message:

DISPLAY AND PRINT
REPORT TYPE: DAILY

OR

To change the report type to daily and print a report for all products, press ENTER in response to the message:

DISPLAY AND PRINT
REPORT TYPE: DAILY

Then press STEP when this message appears:

DISPLAY AND PRINT
PRESS <STEP> TO CONTINUE

Press BACKUP, then press PRINT when this message appears:

DISPLAY AND PRINT
REPORT TYPE: DAILY

Specific Product--To print a daily Reconciliation Report for a specific product, press STEP. The system displays the message:

REPORT TYPE: DAILY
PROD 1: (Product)

To print a daily Reconciliation Report for the selected product, press PRINT. To select a different product, press TANK/SENSOR, then press PRINT. To continue, press STEP. The system displays the message:

PROD 1: (Product)
SELECT DAY: (Date)

Specific Day--To print a Reconciliation Report for the selected day, press PRINT. To select a different date, press CHANGE, enter the date, and then press ENTER. This message appears:

SELECT DAY: (Date)
PRESS <STEP> TO CONTINUE

Press STEP, then press PRINT.

To select a different product, press TANK/SENSOR. To continue, press STEP. The system displays the message:

PROD 1: (Product)
(Day) OPEN: (Date)

The system displays the Daily Report's opening date. You can continue to press STEP to display the daily reconciliation data, one item at a time.

- Opening date
- Closing date
- Opening time
- Closing time

- Opening volume
- Sales (gallons pumped for the day)
- Calculated inventory for the day
- Water height
- Deliveries (gallons delivered for the day)
- Manual adjustments for the day
- Gauged inventory (actual inventory measured by probes in gallons) for the day
- Variance (between calculated and gauged inventory)

PERIODIC

To print a periodic report, press **CHANGE** **twice** in response to the message:

**DISPLAY AND PRINT
REPORT TYPE: SHIFT**

All Products--To print a periodic report for all products, press **CHANGE**, then press **PRINT** in response to the message:

**DISPLAY AND PRINT
REPORT TYPE: SHIFT**

The system displays the message:

**DISPLAY AND PRINT
REPORT TYPE: PERIODIC**

OR

To change the report type to periodic and print a report for all products, press **ENTER** in response to the message:

**DISPLAY AND PRINT
REPORT TYPE: PERIODIC**

Then press **STEP** when this message appears:

**DISPLAY AND PRINT
PRESS <STEP> TO CONTINUE**

Press **BACKUP**, then press **PRINT** when this message appears:

**DISPLAY AND PRINT
REPORT TYPE: PERIODIC**

PERIODIC REPORT FOR CURRENT OR PREVIOUS PERIOD

To print a Periodic Report for a selected period and product, press **FUNCTION**, if necessary, to select the Reconciliation Report function:

**DISPLAY AND PRINT
REPORT TYPE: PERIODIC**

Press **STEP** until you display the message:

**PROD1: (Product)
SELECT PERIOD: CURRENT**

To print a Periodic Report for the selected period and product, press PRINT. To print a report for the previous period, press CHANGE. The system displays the message:

```
PROD1: (Product)
SELECT PERIOD: PREVIOUS
```

Press ENTER; the system displays this message:

```
SELECT PERIOD: PREVIOUS
PRESS <STEP> TO CONTINUE
```

Press STEP; this message appears:

```
PROD1: (Product)
CUR PERI OPEN: (Date)
```

Press PRINT.

DISPLAYING PERIODIC REPORT ACTIVITIES

To display information about the Periodic Report, press STEP until the system displays the message:

```
PROD1: (Product)
CUR PERI OPEN: (Date)
```

The system displays the opening date for the selected period of the Periodic Report. You can continue to press STEP to display the same Periodic Report data as in the report, one item at a time:

- Opening date
- Closing date
- Opening volume
- Sales (gallons pumped for the day)
- Calculated inventory for the day
- Water height
- Threshold (if the variance is greater than this calculated alarm threshold value, the Product Threshold Alarm is activated)
- Opening time
- Closing time
- Deliveries (gallons delivered for the day)
- Manual adjustments for the day
- Gauged inventory (actual inventory measured by probes in gallons) for the day
- Variance (between calculated and gauged inventory)

SHIFT REPORT FOR A SELECTED PRODUCT – ALL SHIFTS

To print a Shift Report for a selected product for all shifts, press FUNCTION, if necessary, to select the Reconciliation Report function:

```
DISPLAY AND PRINT
PRESS <STEP> TO CONTINUE
```

Press STEP until you display the message:

```
REPORT TYPE: SHIFT
PROD1: (Product)
```

To print a shift report for the displayed product, press PRINT. To select a different product, press TANK/SENSOR, then press ENTER.

SHIFT REPORT FOR CURRENT OR PREVIOUS SHIFT

To print a Shift Report for a selected shift, press FUNCTION, if necessary, to select the Reconciliation Report function:

**DISPLAY AND PRINT
PRESS <STEP> TO CONTINUE**

Press STEP until you display the message:

**PROD1: (Product)
SELECT SHIFT: CURRENT**

To print a Shift Reconciliation Report for the selected shift, press PRINT. To select a different product number, press TANK/SENSOR. To print a report for the previous shift, press CHANGE. The system displays the message:

**PROD1: (Product)
SELECT SHIFT: PREVIOUS**

Press ENTER; this message appears:

**SELECT SHIFT: PREVIOUS
PRESS <STEP> TO CONTINUE**

Press BACKUP, then press PRINT when this message appears:

**PROD1: (Product)
SELECT SHIFT: PREVIOUS**

DISPLAYING SHIFT ACTIVITIES

To view information about the shift, such as shift starting and closing times, deliveries and sales, press FUNCTION, if necessary, to select the Reconciliation Report function:

**DISPLAY AND PRINT
PRESS <STEP> TO CONTINUE**

Press STEP until you display the message:

**PROD1: (Product)
CUR SHFT OPEN: (Date)**

The system displays the shift opening date. You can continue to press STEP to display the same shift reconciliation data as in the report, one item at a time.

Variance Reports

If enabled in the Setup Mode, you can generate Delivery Variance Reports, Book Variance Reports, and Variance Analysis Reports. These reports are available daily, weekly, and periodically (based on current and previous reconciliation periods). You can select Variance Reports by tank and product.

DELIVERY VARIANCE REPORTS

Delivery Variance Reports show:

- Opening and closing dates and times
- Ticketed delivery volume--entered manually

- Gauged delivery volume--difference between volume before and after delivery as reported by gauge
- Delivery variance--difference between gauged and ticketed delivery volumes

Daily

To print daily Delivery Variance Reports, press FUNCTION until this message below appears. Press STEP to continue.

DISPLAY AND PRINT DLVY
PRESS <STEP> TO CONTINUE

All Products--To print a daily Delivery Variance Report for all products, press PRINT when this message appears:

DISPLAY AND PRINT DLVY
SELECT: DAILY

Specific Product--To print a daily Delivery Variance Report for a specific product, press STEP. This message appears:

SELECT: DAILY
PROD 1: (Product)

Press PRINT. To select a different product, press TANK/SENSOR, then press PRINT. To continue, press STEP. This message appears:

PROD 1: (Product)
SELECT DAY: (Date)

Specific Day--To print a daily Delivery Variance Report for the selected day, press PRINT. To select the previous month and day (as defined by the reconciliation period), press CHANGE, then press ENTER. This message appears:

SELECT DAY: (Date)
PRESS <STEP> TO CONTINUE

Press STEP, then press PRINT.

To select a different product, press TANK/SENSOR. To continue, press STEP. This message appears:

PROD 1: (Product)
(Day) OPEN: (Date)

The opening date for the daily Delivery Variance Report is displayed. You can continue to press STEP to display daily delivery variance data, one item at a time.

- | | |
|--|---|
| • Opening date | • Opening time |
| • Closing date | • Closing time (based on automatic daily closing; see "Reconciliation Setup," in <i>System Setup Manual</i>) |
| • Ticketed volume | • Gauged volume |
| • Variance (difference in gauged and ticketed volumes) | |

Weekly

To print weekly Delivery Variance Reports, press FUNCTION until this message below appears. Press STEP to continue.

DISPLAY AND PRINT DLVY
PRESS <STEP> TO CONTINUE

To change to weekly Delivery Variance Reports, press CHANGE when this message appears.

DISPLAY AND PRINT DLVY
SELECT: DAILY

All Products--To print a weekly Delivery Variance Report for all products for the current week, press PRINT when the message below appears. Then press ENTER to continue.

DISPLAY AND PRINT DLVY
SELECT: WEEKLY

Press STEP when this message appears:

SELECT: WEEKLY
PRESS <STEP> TO CONTINUE

Specific Product--To print a weekly Delivery Variance Report for the selected product for the current week, press PRINT when this message appears

SELECT: WEEKLY
PROD 1: (Product)

To select a different product, press TANK/SENSOR, then press PRINT. To continue, press STEP. This message appears:

PROD 1: (Product)
SELECT WEEK: CURRENT

Specific Week--To print a weekly Delivery Variance Report for the current week press PRINT. Or, to select the previous week, press CHANGE, then press ENTER. This message appears:

SELECT WEEK: PREVIOUS
PRESS <STEP> TO CONTINUE

Press STEP, then press PRINT.

To select a different product, press TANK/SENSOR. To continue, press STEP. This message appears:

PROD 1: (Product)
(Week) OPEN: (Date)

The opening date for the weekly Delivery Variance Report is displayed. You can continue to press STEP to display weekly delivery variance data, one item at a time.

- Opening date
- Closing date (based on close day of week)
- Ticketed volume
- Variance (difference in gauged and ticketed volumes)
- Opening time
- Closing time
- Gauged volume

Periodic

To print periodic Delivery Variance Reports (based on periodic reconciliation mode; see "Reconciliation Setup" in *System Setup Manual*), press FUNCTION until this message below appears. Press STEP to continue.

DISPLAY AND PRINT DLVY
PRESS <STEP> TO CONTINUE

To change to periodic Delivery Variance Reports, press **CHANGE twice** when this message appears.

DISPLAY AND PRINT DLVY
SELECT: DAILY

All Products--To print a periodic Delivery Variance Report for all products for the current period, press **PRINT** when the message below appears. Then press **ENTER** to continue.

DISPLAY AND PRINT DLVY
SELECT: PERIODIC

Press **STEP** when this message appears:

SELECT: PERIODIC
PRESS <STEP> TO CONTINUE

Specific Product--To print a periodic Delivery Variance Report for the selected product for the current period, press **PRINT** when this message appears

SELECT: PERIODIC
PROD 1: (Product)

To select a different product, press **TANK/SENSOR**, then press **PRINT**. To continue, press **STEP**. This message appears:

PROD 1: (Product)
SELECT PERIOD: CURRENT

Specific Period--To print a periodic Delivery Variance Report for the current period press **PRINT**. Or, to select the previous period, press **CHANGE**, then press **ENTER**. This message appears:

SELECT PERIOD: PREVIOUS
PRESS <STEP> TO CONTINUE

Press **STEP**, then press **PRINT**.

To select a different product, press **TANK/SENSOR**. To continue, press **STEP**. This message appears:

PROD 1: (Product)
(Period) OPEN: (Date)

The opening date for the periodic Delivery Variance Report is displayed. You can continue to press **STEP** to display periodic delivery variance data, one item at a time.

- Opening date
- Closing date
- Ticketed volume
- Variance (difference in gauged and ticketed volumes)
- Opening time
- Closing time
- Gauged volume

Sample Delivery Variance Report

A sample report is shown below:

```

PROD 1:UNLEADED GASOLIN

DELIVERY VARIANCE
CURRENT WEEK

MMM DD, YYYY HH:MM XM
VOLUMES ARE STANDARD

OPENING DATE & TIME:
MMM DD, YYYY HH:MM XM

CLOSING DATE & TIME:
MMM DD, YYYY HH:MM XM

TICKET VOL :      800 GAL
GAUGED VOL  :      899 GAL
DLVY VAR   :       99 GAL
% VAR SALES:      11.23%
  
```

BOOK VARIANCE REPORTS

Book Variance Reports show:

- Opening and closing dates and times
- Metered sales
- Manual adjustments
- Closing gauged volume
- Book variance--closing gauged volume-book inventory
- Opening gauged volume
- Total ticketed delivery volume
- Book inventory--opening gauged volume-metered sales+total ticketed delivery volume+manual adjustments
- Water height
- % variance sales--book variance divided by sales (amount dispensed)

Daily

To print daily Book Variance Reports, press FUNCTION until this message below appears. Press STEP to continue.

**BOOK VARIANCE
PRESS <STEP> TO CONTINUE**

All Products--To print a daily Book Variance Report for all products, press PRINT when this message appears:

**BOOK VARIANCE
SELECT: DAILY**

Specific Product--To print a daily Book Variance Report for a specific product, press STEP. This message appears:

**SELECT: DAILY
PROD 1: (Product)**

Press PRINT. To select a different product, press TANK/SENSOR, then press PRINT. To continue, press STEP. This message appears:

```
PROD 1: (Product)
SELECT DAY: (Date)
```

Specific Day--To print a daily Book Variance Report for the selected day, press PRINT. To select the previous month and day (as defined by the reconciliation period), press CHANGE, then press ENTER. This message appears:

```
SELECT DAY: (Date)
PRESS <STEP> TO CONTINUE
```

Press STEP, then press PRINT.

To select a different product, press TANK/SENSOR. To continue, press STEP. This message appears:

```
PROD 1: (Product)
(Day) OPEN: (Date)
```

The opening date for the daily Book Variance Report is displayed. You can continue to press STEP to display daily book variance data, one item at a time.

- Opening date
- Closing date
- Opening gauged volume
- Ticketed volume
- Book inventory (opening gauged volume-book inventory)
- Water height
- Opening time
- Closing time (based on automatic daily closing; see "Reconciliation Setup," in *System Setup Manual*)
- Metered sales
- Manual adjustment
- Closing gauged volume
- Book variance (difference between gauged volume and book inventory) and % variance sales (book variance divided by sales)

Weekly

To print weekly Book Variance Reports, press FUNCTION until this message below appears. Press STEP to continue.

```
BOOK VARIANCE
PRESS <STEP> TO CONTINUE
```

To change to weekly Book Variance Reports, press CHANGE when this message appears.

```
BOOK VARIANCE
SELECT: DAILY
```

All Products--To print a weekly Book Variance Report for all products for the current week, press PRINT when the message below appears. Then press ENTER to continue.

```
BOOK VARIANCE
SELECT: WEEKLY
```

Press STEP when this message appears:

```
SELECT: WEEKLY
PRESS <STEP> TO CONTINUE
```

Specific Product--To print a weekly Book Variance Report for the selected product for the current week, press PRINT when this message appears

**SELECT: WEEKLY
PROD 1: (Product)**

To select a different product, press TANK/SENSOR, then press PRINT. To continue, press STEP. This message appears:

**PROD 1: (Product)
SELECT WEEK: CURRENT**

Specific Week--To print a weekly Book Variance Report for the current week press PRINT. Or, to select the previous week, press CHANGE, then press ENTER. This message appears:

**SELECT WEEK: PREVIOUS
PRESS <STEP> TO CONTINUE**

Press STEP, then press PRINT.

To select a different product, press TANK/SENSOR. To continue, press STEP. This message appears:

**PROD 1: (Product)
(Week) OPEN: (Date)**

The opening date for the weekly Book Variance Report is displayed. You can continue to press STEP to display weekly delivery variance data, one item at a time.

- | | |
|---|--|
| • Opening date | •Opening time |
| • Closing date (based on close day of week) | •Closing time (based on automatic daily closing) |
| • Opening gauged volume | •Metered sales |
| • Ticketed volume | •Manual adjustment |
| • Book inventory (opening gauged volume-book inventory) | •Closing gauged volume |
| • Water height | •Book variance (difference between gauged volume and book inventory) and % variance sales (book variance divided by sales) |

Periodic

To print periodic Book Variance Reports (based on periodic reconciliation mode; see "Reconciliation Setup" in *System Setup Manual*), press FUNCTION until this message below appears. Press STEP to continue.

**BOOK VARIANCE
PRESS <STEP> TO CONTINUE**

To change to periodic Book Variance Reports, press CHANGE **twice** when this message appears.

**BOOK VARIANCE
SELECT: DAILY**

All Products--To print a periodic Book Variance Report for all products for the current period, press PRINT when the message below appears. Then press ENTER to continue.

**BOOK VARIANCE
SELECT: PERIODIC**

Press STEP when this message appears:

**SELECT: PERIODIC
PRESS <STEP> TO CONTINUE**

Specific Product--To print a periodic Book Variance Report for the selected product for the current period, press PRINT when this message appears

**SELECT: PERIODIC
PROD 1: (Product)**

To select a different product, press TANK/SENSOR, then press PRINT. To continue, press STEP. This message appears:

**PROD 1: (Product)
SELECT PERIOD: CURRENT**

Specific Period--To print a periodic Book Variance Report for the current period press PRINT. Or, to select the previous period, press CHANGE, then press ENTER. This message appears:

**SELECT PERIOD: PREVIOUS
PRESS <STEP> TO CONTINUE**

Press STEP, then press PRINT.

To select a different product, press TANK/SENSOR. To continue, press STEP. This message appears:

**PROD 1: (Product)
(Period) OPEN: (Date)**

The opening date for the periodic Book Variance Report is displayed. You can continue to press STEP to display periodic delivery variance data, one item at a time.

- Opening date
- Closing date
- Opening gauged volume
- Ticketed volume
- Book inventory (opening gauged volume-book inventory)
- Water height
- Opening time
- Closing time (based on automatic daily closing; see "Reconciliation Setup," in *System Setup Manual*)
- Metered sales
- Manual adjustment
- Closing gauged volume
- Book variance (difference between gauged volume and book inventory) and sales variance (delivery variance divided by sales)

Sample Book Variance Report

A sample report is shown below:

```

PROD 1:UNLEADED GASOLIN

BOOK VARIANCE
DAILY

MMM DD, YYYY HH:MM XM
VOLUMES ARE STANDARD

OPENING DATE & TIME:
MMM DD, YYYY HH:MM XM

CLOSING DATE & TIME:
MMM DD, YYYY HH:MM XM

OPN GAUG VOL      :          800 GAL
METER SALES       :          285 GAL
TICKET DLVY      :          800 GAL
MANUAL ADJ        :           0 GAL
BOOK INV          :          9704 GAL
GAUGED INV        :          8904 GAL
WATER HT          :           0.00 IN
VAR               :      800 GAL 280.7%

```

VARIANCE ANALYSIS REPORTS

Variance Analysis Reports show:

- Book variance--(opening gauged volume-metered sales+total ticketed delivery volume+manual adjustments)-(closing gauged volume)
- Book variance %--book variance divided by sales (amount dispensed)
- Delivery variance--difference between ticketed and gauged volumes
- Sales variance--difference between book variance and delivery variance
- Temperature variance--change in volume related to change in temperature
- Water change--change in water height
- Unexplained variance--change in volume due to other factors, such as leaks or vapor loss
- Tank chart alarm or calibration failure
- Latest tank test (static or CSLD) results
- Latest line leak test results
- Latest HRM (Europe only) test results
- Corrective action for tank chart alarm, calibration failure, or failed tank or line tests

Daily

To print daily Variance Analysis Reports, press FUNCTION until this message below appears. Press STEP to continue.

**DISPLAY AND PRINT DLVY
PRESS <STEP> TO CONTINUE**

All Products--To print a daily Variance Analysis Report for all products, press PRINT when this message appears:

**VARIANCE ANALYSIS
SELECT: DAILY**

Specific Product--To print a daily Variance Analysis Report for a specific product, press STEP. This message appears:

**SELECT: DAILY
PROD 1: (Product)**

Press PRINT. To select a different product, press TANK/SENSOR, then press PRINT. To continue, press STEP. This message appears:

**PROD 1: (Product)
SELECT DAY: (Date)**

Specific Day--To print a daily Variance Analysis Report for the selected day, press PRINT. To select the previous month and day (as defined by the reconciliation period), press CHANGE, then press ENTER. This message appears:

**SELECT DAY: (Date)
PRESS <STEP> TO CONTINUE**

Press STEP, then press PRINT.

To select a different product, press TANK/SENSOR. To continue, press STEP. This message appears:

**PROD 1: (Product)
(Day) OPEN: (Date)**

The opening date for the daily Variance Analysis Report is displayed. You can continue to press STEP to display daily variance analysis data, one item at a time.

- | | |
|---|---|
| • Opening date | • Opening time |
| • Closing date | • Closing time (based on automatic daily closing; see "Reconciliation Setup," in <i>System Setup Manual</i>) |
| • Book variance (gauged volume-calculated volume) | • Book variance % (book variance divided by sales) |
| • Delivery variance (ticketed volume-gauged volume) | • Sales variance (book variance-delivery variance) |
| • Temperature variance | • Water change |
| • Unexplained variance | |

Weekly

To print weekly Variance Analysis Reports, press FUNCTION until this message below appears. Press STEP to continue.

VARIANCE ANALYSIS
PRESS <STEP> TO CONTINUE

To change to weekly Variance Analysis Reports, press CHANGE when this message appears.

VARIANCE ANALYSIS
SELECT: DAILY

All Products--To print a weekly Variance Analysis Report for all products for the current week, press PRINT when the message below appears. Then press ENTER to continue.

BOOK VARIANCE
SELECT: WEEKLY

Press STEP when this message appears:

SELECT: WEEKLY
PRESS <STEP> TO CONTINUE

Specific Product--To print a weekly Variance Analysis Report for the selected product for the current week, press PRINT when this message appears

SELECT: WEEKLY
PROD 1: (Product)

To select a different product, press TANK/SENSOR, then press PRINT. To continue, press STEP. This message appears:

PROD 1: (Product)
SELECT WEEK: CURRENT

Specific Week--To print a weekly Variance Analysis Report for the current week press PRINT. Or, to select the previous week, press CHANGE, then press ENTER. This message appears:

SELECT WEEK: PREVIOUS
PRESS <STEP> TO CONTINUE

Press STEP, then press PRINT.

To select a different product, press TANK/SENSOR. To continue, press STEP. This message appears:

PROD 1: (Product)
(Week) OPEN: (Date)

The opening date for the weekly Variance Analysis Report is displayed. You can continue to press STEP to display weekly variance analysis data, one item at a time.

- | | |
|---|--|
| • Opening date | • Opening time |
| • Closing date (based on close day of week) | • Closing time (based on automatic daily closing) |
| • Book variance (gauged volume-calculated volume) | • Book variance % (book variance divided by sales) |
| • Delivery variance (ticketed volume-gauged volume) | • Sales variance (book variance-delivery variance) |

- Temperature variance
- Unexplained variance
- Water change

Periodic

To print periodic Variance Analysis Reports (based on periodic reconciliation mode; see “Reconciliation Setup” in *System Setup Manual*), press FUNCTION until this message below appears. Press STEP to continue.

VARIANCE ANALYSIS
PRESS <STEP> TO CONTINUE

To change to periodic Variance Analysis Reports, press CHANGE **twice** when this message appears.

VARIANCE ANALYSIS
SELECT: DAILY

All Products--To print a periodic Variance Analysis Report for all products for the current period, press PRINT when the message below appears. Then press ENTER to continue.

VARIANCE ANALYSIS
SELECT: PERIODIC

Press STEP when this message appears:

SELECT: PERIODIC
PRESS <STEP> TO CONTINUE

Specific Product--To print a periodic Variance Analysis Report for the selected product for the current period, press PRINT when this message appears

SELECT: PERIODIC
PROD 1: (Product)

To select a different product, press TANK/SENSOR, then press PRINT. To continue, press STEP. This message appears:

PROD 1: (Product)
SELECT PERIOD: CURRENT

Specific Period--To print a periodic Variance Analysis Report for the current period press PRINT. Or, to select the previous period, press CHANGE, then press ENTER. This message appears:

SELECT PERIOD: PREVIOUS
PRESS <STEP> TO CONTINUE

Press STEP, then press PRINT.

To select a different product, press TANK/SENSOR. To continue, press STEP. This message appears:

PROD 1: (Product)
(Period) OPEN: (Date)

The opening date for the periodic Variance Analysis Report is displayed. You can continue to press STEP to display periodic delivery variance data, one item at a time.

- Opening date
- Closing date
- Opening time
- Closing time (based on automatic daily closing; see “Reconciliation Setup,” in *System Setup Manual*)

- Book variance (gauged volume-calculated volume)
- Delivery variance (ticketed volume-gauged volume)
- Temperature variance
- Unexplained variance
- Book variance % (book variance divided by sales)
- Sales variance (book variance-delivery variance)
- Water change

SAMPLE VARIANCE ANALYSIS REPORT

```

PROD 1:UNLEADED GASOLIN

VARIANCE ANALYSIS
DAILY

MMM DD, YYYY HH:MM XM
VOLUMES ARE STANDARD

OPENING DATE & TIME:
MMM DD, YYYY HH:MM XM

CLOSING DATE & TIME:
MMM DD, YYYY HH:MM XM

BOOK VAR      : 800 GAL
BOOK VAR %    : 280 GAL
DLVY VAR      : -99 GAL
SALE VAR      : 899 GAL
TEMP VAR      : 3 GAL
WATER CHG     : 0.00 IN
UNEX VAR      : 895 GAL

CHART ALM     : T 1
CALIB FAIL    : T 1

CORRECTIVE ACTIONS
-----
INSPECT METERS
T1

LEAK TEST RESULTS
-----
T 1: UNLEADED GASOLINE
PROBE SERIAL NUM 627020

0.20 GAL/HR TEST PASS
MMM DD, YYYY HH:MM XM

0.10 GAL/HR TEST PASS
MMM DD, YYYY HH:MM XM

MONTHLY TANK TEST REPORT
-----
T 1: UNLEADED GASOLINE
PROBE SERIAL NUM 627020

TEST TYPE: STANDARD
PERCENT VOLUME = 24.8
MMM DD, YYYY HH:MM XM
    
```

How to Manually Adjust Reconciliation Reports

Manual adjustments (i.e., adding product back into inventory) need to be made to adjust the shift volume if a discrepancy occurs. Manual adjustments should also be made when product is dispensed and poured back into the tank, as during dispenser service or dispenser calibration tests.

You can adjust the volume for the previous or current shift or for any day in the period (Monthly or Rolling - selected in setup, see the Reconciliation Section of the System Setup Manual, "Periodic Reconciliation Mode" entry).

To make a manual adjustment, press FUNCTION until you display the message:

```
MANUAL ADJUSTMENTS
PRESS <STEP> TO CONTINUE
```

SHIFT ADJUSTMENT

To make a shift adjustment, press STEP in response to the MANUAL ADJUSTMENTS message. The system displays the message:

```
T 1: (Product Name)
ADJUSTMENT TYPE: SHIFT
```

Press STEP to continue. The system displays the message:

```
T 1: (Product Name)
SELECT SHIFT: CURRENT
```

To make an adjustment to the **current** shift, press STEP. To make an adjustment to a **previous** shift, press CHANGE, then press ENTER, then press STEP. The system displays the message:

```
T 1: (Product Name)
(Selected) SHFT ADJ VOL: XXXXXX
```

Press CHANGE. Enter the total positive or negative adjustment volume in gallons, then press ENTER. The system confirms your entry:

```
(Selected) SHFT ADJ VOL: XXXXXX
PRESS <STEP> TO CONTINUE
```

DAILY ADJUSTMENT

To make a daily adjustment, press STEP in response to the MANUAL ADJUSTMENTS message. The system displays the message:

```
T 1: (Product Name)
ADJUSTMENT TYPE: SHIFT
```

Press CHANGE to select Daily. The system displays your selection:

```
ADJUSTMENT TYPE: DAILY
PRESS <STEP> TO CONTINUE
```

Press ENTER to confirm the selection, then press STEP. The system displays the message:

```
T 1: (Product Name)
SELECT DAY: (Current Date)
```

To select the current date, press STEP. To select a different date, press CHANGE. Enter the desired closing date for the adjustment, then press ENTER. The system confirms the date. Press STEP to continue. The system displays the message:

```
T 1: (Product Name)
(Date) ADJ VOL: XXXXXX
```

Press CHANGE. Enter the total adjustment volume in gallons for the selected day, then press ENTER. The system confirms the entry:

```
(Date) ADJ VOL: XXXXXX
PRESS <STEP> TO CONTINUE
```

To return to the SELECT DAY message, press STEP. To exit this function, press FUNCTION.

Adjusted Delivery Reports

When the system recognizes that a delivery occurred, an adjusted delivery report is automatically printed for single or manifolded tanks. The adjusted delivery report takes into consideration all dispensing that occurred during the delivery.

SINGLE TANK ADJUSTED DELIVERY SAMPLE REPORT

```
T 1: (product label)
ADJUSTED DELIVERY REPORT
-----
MMM DD, YYYY HH:MM XM

DELIVERY VOLUME   =   1200
TC DLVY VOLUME    =   1189
```

MANIFOLDED TANKS ADJUSTED DELIVERY SAMPLE REPORT

```
T 2: PRODUCT 2
T 3: PRODUCT 2
ADJUSTED DELIVERY REPORT
-----
MMM DD, YYYY HH:MM XM

DELIVERY VOLUME   =   2200
TC DLVY VOLUME    =   2183
```

29 Troubleshooting

This section helps you troubleshoot problems that could occur during system operation. The system monitors for warning and alarm conditions, such as fuel leaks, inventory limit excesses, and equipment problems.

When no warning or alarm conditions exist, the system displays the ALL FUNCTIONS NORMAL message. If an alarm or warning condition does exist, the system displays the type and location of the condition. If more than one condition exists, the display will alternately flash all messages.

Calling for Help

If you try all of the suggestions in this manual and you still need assistance, call an authorized Veeder-Root service representative for service following the procedures established for your site.

Warnings and Alarms

 WARNING	
	<p>Attempting to service tank monitors and equipment without proper training can be dangerous.</p> <p>Fire or explosion or electrical shock resulting in serious injury or death could result.</p> <p>Read and follow all safety warnings. If you have not been trained in proper service procedures and hazards involved, refer all service to a qualified Veeder-Root Service Representative.</p>

 Response instructions for each type of warning or alarm condition should be established and clearly posted by the person responsible for your site. **Be sure all personnel are familiar with the warning and alarm response procedures for your site!**

AUDIBLE ALARM

Press ALARM/TEST to silence the alarm.

WARNING LIGHTS

You cannot turn off warning and alarm lights until you correct the cause of the warning or alarm. When you correct the condition, the lights will shut off.

MESSAGES

Warning and Alarm Messages display until you correct the cause of the problem. After you correct the cause, you must press the ALARM/TEST button to acknowledge the alarm and clear the display. The system will then display the ALL FUNCTIONS NORMAL message.

ALARM REPORTS

If your system has a printer, it will print an alarm or warning report when it detects a warning or alarm condition. This report shows the type and location of the warning or alarm and the date and time it occurred.

Warning and Alarm Messages

Alarm displays tell you the location and type of alarm. For example, this display with the second line flashing:

```
MMM DD, YYYY HH:MM XM
T3: LOW PRODUCT ALARM
```

indicates that fuel level in T3 has dropped below its low level limit and it is time to call for a delivery (T is the Device code for Tank and 3 indicates that it is Tank 3).

To troubleshoot a device-specific alarm, identify the device by using Table 29-1 below. This table contains a list of all Device Codes and their descriptions.

After identifying the device, refer to all the rest of the tables in this section for alarm messages and suggested corrective action. If the suggested action does not correct the alarm, call for service following the procedures established for your site.

Table 29-1.- Device Codes and Descriptions

Device Code	Description	Device Code	Description
C	2-wire C.L. sensor (Type A)	R	Output relay
D	Receiver (phone, fax, etc.)	r	Pump Relay Monitor
E ²	BDIM, EDIM, or CDIM modules	S	Pump sensor
G	Groundwater sensor	s	Smart sensor
H	3-wire C.L. sensor (Type B)	T	In-tank probe
I	External input device	U	Universal 3-wire
L	Liquid sensor	V	Vapor sensor
M ²	MDIM module	W	WPLLD
P ¹	VLLD	X	VMCI interface module
Q	PLLD	x	VMC (vapor monitoring controller)

¹TLS-350 Plus/TLS-350R Only

²TLS-350R only

Table 29-2.- System Status Displayed Messages

Display Message	Front Panel Indicator	Cause	Action
BATTERY IS OFF	Alarm	Battery switch is off.	You will lose system programming if AC power to the console is interrupted. Call for service following the procedures established for your site.
FEPROM WRITE FAILURE	Alarm	A memory error has occurred on the NVMEM board.	Replace the NVMEM board and cold start the TLS Console.
NO MT COMM	Alarm	Maintenance Tracker is enabled; the MT Comm board has been removed.	Install MT Comm board.
NO NVMEM	Alarm	NVMEM board is needed to support Maintenance Tracker.	Install NVMEM 203 board.
PAPER OUT	Warning	Paper roll empty.	Replace the paper roll with Veeder-Root part number 514100-328 only.
PC(H8) REVISION WARN	Warning	The CPU board communications software version is not compatible.	Call for service following the procedures established for your site.
PRINTER ERROR	Warning	Printer feed roller release is open.	Push the release lever (under the lower right corner of the printer cover) to the up position.
PROTECTIVE COVER ALARM	Alarm	Safety cover over power area removed.	Replace cover.
RAM ERR ADDR = 01E80000 RAM ERR DATA = XXXXXXXX	Alarm	V24 or higher software installed with older ECPU board.	Replace ECPU board or install NVMEM 102 board.
REMOTE DISPLAY ERROR	Warning	The Remote Display is not communicating properly.	Refer to the System Setup Manual, or call for service following the procedures established for your site.
ROM REVISION WARNING	Warning	Software revisions do not match. The software was replaced in the unit with the backup battery switch SW1 in the ON position.	Call for service following the procedures established for your site.
SERVICE NOTICE	Warning	Service Session enabled.	Cleared manually following service session or automatically after timeout (max 8 hours).
SOFTWARE MODULE WARN	Warning	The wrong software module is installed; or, the software module cannot be read or has an invalid checksum.	Call for service following the procedures established for your site.
SYS MAINT NVMEM ERR	Alarm	Maintenance History NVMEM card removed	Replace card and perform a cold boot.
SYS MT SER CARD ERR	Alarm	Maintenance History 402k serial card removed	

Table 29-2.- System Status Displayed Messages

Display Message	Front Panel Indicator	Cause	Action
SYSTEM SELF-TEST ALM	Alarm	The backup battery was turned on before the system was completely powered up and initialized	Set battery backup switch (S1 or SW1) to the OFF position. Turn off AC power to the console. Power up console first. Wait for system display to read "Battery Is Off" then set the switch to the ON position.
TOO MANY TANKS	Warning	The system detects more tank inputs than the system is designed for. The maximum number of probes has been exceeded.	Call for service following the procedures established for your site.
WRONG SOFTWARE WARNING	Warning	This alarm occurs in a TLS-300 if TLS-350 software is installed.	Install correct software.

Table 29-3.- In-Tank Leak Detection Displayed Messages

Display Message	Front Panel Indicator	Cause	Action
ANN TST NEEDED ALM	Alarm	An annual in-tank leak test has not been successfully completed within the preset time period.	Schedule a 0.1 gph (0.38 lph) test.
ANN TST NEEDED WRN	Warning	An annual in-tank leak test has not been successfully completed within the preset time period.	Schedule a 0.1 gph (0.38 lph) test.
ANNUAL TEST FAIL	Alarm	In-tank leak annual (0.1 gph [0.38 lph]) test failed.	Rerun in-tank leak test. If second test fails, call for service.
CSLD INCR RATE WRN	Warning	An excessive amount of fluid leaked into the tank during a test period.	Call for service following the procedures established for your site.
DELIVERY NEEDED	Warning	Product level dropped below preset limit.	Call for delivery.
DELIVY DENSITY WRN	Warning	Indicates when delivery density has not been entered	Enter delivery density or correct entered delivery density.
FUEL QUALITY ALARM	Alarm	Potential Causes: High density fuel; Delivery of phase separated fuel; Delivery of incorrect fuel type.	If tank has just had a delivery, check to ensure correct fuel type was delivered. Test fuel at bottom of tank to ensure water/phase separation is not present.
GROSS FAIL LINE TNK	Alarm	Line or Tank failed a (3.0 gph [11.3 lph]) leak test.	Rerun in-tank or line leak test. If second test fails, call for service.
GROSS TEST FAIL	Alarm	In-tank leak (3.0 gph [11.3 lph]) test failed.	Rerun in-tank leak test. If second test fails, call for service.
HIGH PRODUCT ALARM	Warning	Product level in tank rose above preset limit.	Do not allow additional delivery until product is dispensed below preset limit.

Table 29-3.- In-Tank Leak Detection Displayed Messages

Display Message	Front Panel Indicator	Cause	Action
HIGH WATER WARNING	Warning	Water detected in tank exceeds preset limit.	Remove water from the tank.
INVALID FUEL LEVEL (Mag probes only)	Alarm	Fuel level dropped to a point below the minimum detectable level or only one float is present.	Call for delivery.
LEAK ALARM	Alarm	A static in-tank leak test failed.	Rerun in-tank leak test.
LOW PRODUCT ALARM	Alarm	Tank level dropped below preset limit.	Call for delivery.
LOW TEMP WARNING	Warning	Probe temperature drops below -4°F (-15.6°C).	Probe returns to normal operation after probe temperature rises above 0°F (-17.8°C).
MAX PRODUCT ALARM	Alarm	Product level rose above preset limit.	Stop delivery. Do not allow additional delivery until product drops below preset limit.
MISSING TICKET WARN	Warning	Missing ticketed delivery.	Insert missed Ticket Delivery data.
NO CSLD IDLE TIME	Warning	System has not had enough idle time over previous 24 hours to run a statistical leak detection test.	Stop dispensing fuel from this tank until CSLD test is complete.
OVERFILL ALARM	Alarm	Potential overflow of tank may occur.	Stop delivery. Check for spillage.
PER TST NEEDED ALM	Alarm	A periodic in-tank leak (0.2 gph [0.76 lph]) test has not been successfully completed within the preset time period.	Schedule a 0.2 gph (0.76 lph) test.
PER TST NEEDED WRN	Warning	A periodic in-tank leak test has not been successfully completed within the preset time period.	Schedule a 0.2 gph (0.76 lph) test.
PERIODIC TEST FAIL	Alarm	In-tank leak (0.2 gph [0.76 lph]) test failed.	Rerun in-tank leak test. If second test fails, call for service.
PROBE OUT	Alarm	Hardware failure - probe or interconnecting wiring to console.	Call for service.
SETUP DATA WARNING	Warning	System setup problem or probe out on startup.	Reenter tank setup for problem tank or test probe on another channel.
SUDDEN LOSS ALARM	Alarm	System detects loss of fuel during an idle period.	Check for gross leak.
TANK TEST ACTIVE	Warning	In-tank leak test underway.	Do not dispense fuel from this tank until message disappears.
TANK SIPHON BREAK	Warning	Siphon break valve has shut down manifold for tank test.	Clears when tank test completes.

Table 29-4.- In-Tank Leak Detection Invalidation Criteria

Printout Message (Not displayed)	Probable Cause	Action
RECENT DELIVERY	A delivery occurred during the leak detect test or less than 8 hours before beginning the leak detect test.	Retest, waiting longer than 8 hours after last delivery.
LOW LEVEL TEST ERROR	Fuel level is too low during a tank test.	Call for delivery.
FIRST LEAK PERIOD ERROR	System was unable to obtain enough valid samples (150) to start a leak test during the first leak period (first half hour).	Call for service following the procedures established for your site.
LAST LEAK PERIOD ERROR	System was unable to obtain enough valid samples (150) to start a leak test during the last leak period (last half hour).	Call for service following the procedures established for your site.
TEMPERATURE OUT OF RANGE	Temperature reading is below 0°F (-17.8°C) or above 100° F (37.8°C).	Wait for temperature to reenter the probe's operating range.
TEMP CHANGE TOO LARGE	Average temperature of all submerged thermistors changed by more than 0.1°F (0.06°C) per hour.	Retest.
CHANGE IN TANK TEMP ZONE (Mag Probes only)	A submerged thermistor's temperature changed by more than 0.3°F (0.16°C) per hour.	Retest. If the problem continues, call for service following the procedures established for your site.
CHANGE IN HEAD TEMP (Mag Probes only)	The temperature of the thermistor in the probe head changed by more than 1°F (0.6°C) per hour.	Retest. If the problem continues, call for service following the procedures established for your site.
LEAK TEST TOO SHORT	A periodic test requires at least 2 hours to complete (3 hours for an annual test)	Retest. For manual test runs, allow minimum test times. For programmed test runs, program a longer test time.
PERCENT VOLUME TOO LOW (Mag1 Probes only)	Fuel level is less than the programmed minimum.	Call for delivery.
LOW LEVEL TEST ERROR (Mag Probes only)	Fuel level is too low, causing the fuel and water floats to be too close together.	Call for delivery.
PRODUCT LEVEL INCREASE	Fuel level increased more than the leak rate threshold value during the test.	Call for service following the procedures established for your site.

Table 29-5.- Liquid Sensor Status Indicators - Piping Sump, Steel or Fiberglass Tank Interstitial Sensors

Display Message	Front Panel Indicator	Cause	Action
FUEL ALARM	Alarm	An interstitial or piping sump liquid sensor detects liquid in a tank's interstitial space or piping sump.	Call for service following the procedures established for your site.

Table 29-5.- Liquid Sensor Status Indicators - Piping Sump, Steel or Fiberglass Tank Interstitial Sensors

Display Message	Front Panel Indicator	Cause	Action
SENSOR OUT ALARM	Alarm	A sensor is disconnected or is not functioning properly.	Call for service following the procedures established for your site.
		Liquid sensor setup was performed incorrectly.	Reenter this liquid sensor's setup values.

Table 29-6.- Liquid Sensor Status Indicators - Normally Closed Sensors

Display Message	Front Panel Indicator	Cause	Action
FUEL ALARM	Alarm	An interstitial or piping sump liquid sensor detects liquid in a tank's interstitial space or piping sump.	Call for service following the procedures established for your site.

Table 29-7.- Liquid Sensor Status Indicators - Dual Float Differentiating (Hydrostatic) Sensors

Display Message	Front Panel Indicator	Cause	Action
HIGH LIQUID ALARM	Alarm	A sensor in a brine-filled interstice detects an increase in the brine level increase. Liquid is entering the riser pipe, or in a high groundwater area, an outer wall rupture has occurred.	Call for service following the procedures established for your site.
LOW LIQUID ALARM	Warning	A sensor in a brine-filled interstice detects a decrease in the brine level. A hole is in the tank's inner wall, or in low groundwater areas, a hole is in the outer wall.	Call for service following the procedures established for your site.
SENSOR OUT ALARM	Alarm	A sensor is disconnected or is not functioning properly.	Call for service following the procedures established for your site.

Table 29-8.- Liquid Sensor Status Indicators

Display Message	Front Panel Indicator	Cause	Action
Dual Float Discriminating Dispenser Pan and Containment Sump Sensors			
SHORT ALARM	Alarm	An internal short has occurred in the sensor.	Call for service following the procedures established for your site.
HIGH LIQUID ALARM	Alarm	Liquid reached 8" on the dispenser pan sensor or 10" on the containment sump sensor.	Immediately follow the alarm reporting procedures established for your site.

Table 29-8.- Liquid Sensor Status Indicators (Continued)

Display Message	Front Panel Indicator	Cause	Action
FUEL ALARM	Alarm	Fuel is present in the area being monitored by the sensor.	Immediately follow the alarm reporting procedures established for your site. Refer to the System Setup Manual for more information on recovering from an alarm due to leak or spill in the containment area.
LIQUID WARNING	Warning	Liquid reached 1 inch (25.4 mm) on the dispenser pan or containment sump sensors.	Immediately follow the alarm reporting procedures established for your site.
SENSOR OUT ALARM	Alarm	The sensor is disconnected or is not functioning properly.	Sensor problem must be corrected or sensor replaced. Call for service by following the procedures established for your site.
		Liquid sensor setup was performed incorrectly.	Reenter this liquid sensor's setup values.
Oil/Water Separator Sensor			
SHORT ALARM	Alarm	An internal short has occurred in the sensor.	Call for service following the procedures established for your site.
FUEL ALARM	Alarm	The oil level in the separator tank has reached the critical level defined by the customer at time of purchase.	OIL MUST be pumped out IMMEDIATELY to prevent accidental oil discharge. Tank MUST be filled up with water for proper tank and sensor operation.
LIQUID WARNING	Warning	The oil level in the separator tank has reached a sufficient level as defined by the customer, indicating need to schedule oil removal.	Oil removal should be scheduled as soon as possible. Tank MUST be filled with water for proper tank and sensor operation.
SENSOR OUT ALARM	Alarm	The sensor is disconnected or is not functioning properly.	Sensor problem must be corrected or sensor replaced. Call for service by following the procedures established for your site.
		Liquid sensor setup was performed incorrectly.	Reenter this liquid sensor's setup values.

Table 29-9.- Vapor Sensor Status Indicators

Display Message	Front Panel Indicator	Cause	Action
FUEL ALARM	Alarm	A vapor sensor in an observation well detects fuel vapor levels that exceed the vapor alarm threshold set for that well.	Call for service following the procedures established for your site.
WATER ALARM	Warning	A vapor sensor is immersed in water and is incapable of detecting fuel vapors.	Call for service following the procedures established for your site.

Table 29-9.- Vapor Sensor Status Indicators (Continued)

Display Message	Front Panel Indicator	Cause	Action
SENSOR OUT ALARM	Alarm	A vapor sensor is disconnected or is not functioning properly.	Call for service following the procedures established for your site.
SHORT ALARM	Alarm	An internal short has occurred in a vapor sensor.	Call for service following the procedures established for your site.

Table 29-10.- Receiver Status Indicator

Display Message	Front Panel Indicator	Cause	Action
ALARM CLEAR WARNING	N/A	This alarm occurs if an alarm, which is programmed to autodial, clears.	N/A
AUTODIAL FAILURE	Alarm	System failed to connect to a remote receiver after "n" tries.	Check remote receiver.
DELIVERY REPORT WARN	N/A	If programmed to autodial, this alarm is generated following a delivery.	N/A
NO DIAL TONE ALARM	Alarm	System failed to detect an operational line after 3 tries. Can be enabled only if a SiteFax module is installed.	This alarm must stay active until it is confirmed that the alarm has been reported.
SERVICE REPORT-WARN	N/A	If programmed to autodial, this alarm is generated after a technician enters an ID and code.	N/A

Table 29-11.- Pressurized Line Leak Detector Status Indicators

Display Message	Front Panel Indicator	Cause	Action
ANN TST NEEDED ALM	Alarm	System fails to perform an annual test (0.1 gph [0.76 lph]) in the programmed number of days.	Schedule a 0.1 gph test.
ANN TST NEEDED WRN	Warning	System fails to perform an annual test (0.1 gph [0.76 lph]) in the programmed number of days.	Schedule a 0.1 gph test.
ANNUAL LINE FAIL	Alarm	0.1 gph (0.76 lph) line test failure. Dispensing halts, if programmed to do so.	Consult W/PLLD Alarm Quick Help Guide and Pressure Line Leak Diag (Diagnostic Mode).

Table 29-11.- Pressurized Line Leak Detector Status Indicators (Continued)

Display Message	Front Panel Indicator	Cause	Action
FUEL OUT	Alarm	Tank product level below 10-inch (25.4 cm) level - cannot pump when active.	Schedule a delivery.
GROSS LINE FAIL	Alarm	3 gph (11.3 lph) line test failure. Dispensing halts, if programmed to do so, while the alarm is active.	Consult W/PLLD Alarm Quick Help Guide and Pressure Line Leak Diag (Diagnostic Mode).
CONT HANDLE ALRM	Alarm	Handle signal has been active for a programmed number of hours.	Call for service following the procedures established for your site.
LN EQ FAULT ALM	Alarm	A problem with the pressure measurement equipment has been detected.	Call for service following the procedures established for your site.
LOW PRESSURE ALARM	Alarm	Low pump dispense pressure is detected during a dispense. Dispensing halts if programmed to do so.	The next handle up will restart the pump.
PERIOD LINE FAIL	Alarm	0.2 gph (0.76 lph) test failure. Dispensing halts, if programmed to do so.	Consult W/PLLD Alarm Quick Help Guide and Pressure Line Leak Diag (Diagnostic Mode).
PER TST NEEDED ALM	Alarm	System fails to perform a periodic test (0.2 gph [0.76 lph]) in the programmed number of days.	Schedule a 0.2 gph test.
PER TST NEEDED WRN	Warning	System fails to perform a periodic test (0.2 gph [0.76 lph]) in the programmed number of days.	Schedule a 0.2 gph test.
OPEN ALARM	Alarm	Pressure sensor reading is less than -8 psi (-51.2 kPa). Only tested while the pump is running. Dispensing halts if programmed to do so.	3 gph (11.3 lph) test must pass to clear the alarm. Call for service following the procedures established for your site.
SETUP DATA WARNING	Warning	The default line length was not changed to reflect the actual line length.	Enter the correct line length(s).
SHUTDOWN ALARM	Alarm	System shut down line because of failed line leak test, or an alarm assigned to disable the line is active.	Identify offending alarm, and see above PLLD alarms for corrective action.

Table 29-12.- Wireless Pressurized Line Leak Detector Status Indicators

Display Message	Front Panel Indicator	Cause	Action
ANN TST NEEDED ALM	Alarm	System fails to perform an annual test (0.1 gph [0.38 lph]) in the programmed number of days.	Schedule a 0.1 gph test.
ANN TST NEEDED WRN	Warning	System fails to perform an annual test (0.1 gph) in the programmed number of days.	Schedule a 0.1 gph test.
ANNUAL LINE FAIL	Alarm	0.1 gph line test failure. Dispensing halts if programmed to do so.	Consult W/PLLD Alarm Quick Help Guide and WPLLD Line Leak Diag (Diagnostic Mode).
COMM ALARM	Alarm	Communications disrupted between the system and WPLLD communications board. Alarm is cleared when communication resumes.	Call for service following the procedures established for your site.
FUEL OUT	Alarm	Tank product level below 10-inch level - cannot pump when active.	Schedule a delivery.
GROSS LINE FAIL	Alarm	3 gph (11.3 lph) line test failure. Dispensing halts, if programmed to do so, while the alarm is active.	Consult W/PLLD Alarm Quick Help Guide and WPLLD Line Leak Diag (Diagnostic Mode).
CONT HANDLE ALRM	Alarm	Handle signal has been active for a programmed number of hours.	Call for service following the procedures established for your site.
LN EQ FAULT ALM	Alarm	A problem with the pressure measurement equipment has been detected.	Call for service following the procedures established for your site.
PERIOD LINE FAIL	Alarm	0.2 gph (0.76 lph) line test failure. Dispensing halts if programmed to do so.	Consult W/PLLD Alarm Quick Help Guide and WPLLD Line Leak Diag (Diagnostic Mode).
PER TST NEEDED ALM	Alarm	System fails to perform an annual test (0.2 gph) in the programmed number of days.	Schedule a 0.2 gph test.
PER TST NEEDED WRN	Warning	System fails to perform an annual test (0.2 gph) in the programmed number of days.	Schedule a 0.2 gph test.
SETUP DATA WARNING	Warning	The default line length was not changed to reflect the actual line length.	Enter the correct line length(s).
SHUTDOWN ALARM	Alarm	System shut down line because of failed line leak test, or an alarm assigned to disable the line is active.	Identify offending alarm, and see above WPLLD alarms for corrective action.

Table 29-13.- Volumetric Line Leak Detector Status Indicators

Display Message	Front Panel Indicator	Cause	Action
ANN TST NEEDED ALM	Alarm	The system fails to perform a 0.1 gph (0.38 lph) test in the programmed number of days.	Schedule a 0.1 gph test
ANN TST NEEDED WRN	Warning	The system fails to perform a 0.1 gph test in the programmed number of days.	Schedule a 0.1 gph test
ANN-LINE TEST FAIL	Alarm	0.1 gph line test failure.	Call for service following the procedures established for your site.
ANN-LINE SELF FAIL	Alarm	0.1 gph line self-test failure. (Two consecutive self-test failures.)	Call for service following the procedures established for your site.
ANN-PUMP TEST FAIL	Alarm	0.1 gph Pumpsided Test failure.	Call for service following the procedures established for your site.
ANN-PUMP SELF FAIL	Alarm	0.1 gph pumpsided self-test failure.	Call for service following the procedures established for your site.
FUEL OUT	Alarm	Tank product level below 10 inches (254 mm) and three consecutive 3.0 gph (11.3 lph) self-test failures.	Call for delivery.
GRS LINE TEST FAIL	Alarm	3.0 gph line test failure. (Three consecutive self-test failures.)	Call for service following the procedures established for your site.
GRS LINE SELF FAIL	Alarm	3.0 gph line self-test failure.	Run the same test again. If the system fails, call for service following the procedures established for your site.
GRS PUMP TEST FAIL	Alarm	3.0 gph pumpsided test failure.	Run the same test again. If the system fails, call for service following the procedures established for your site.
GRS PUMP SELF FAIL	Alarm	3.0 gph pumpsided self-test failure.	Run the same test again. If the system fails, call for service following the procedures established for your site.
CONT HANDLE ALRM	Warning	The pump has not turned off for 2 hours.	Call for service following the procedures established for your site.
LINE LEAK SHUT-DOWN	Alarm	Line test or pumpsided test failure.	Call for service following the procedures established for your site.

Table 29-13.- Volumetric Line Leak Detector Status Indicators (Continued)

Display Message	Front Panel Indicator	Cause	Action
LINE LEAK TEST FAIL	Alarm	Line Test or Pumpsided Test Failure.	Call for service following the procedures established for your site.
PER TST NEEDED ALM	Alarm	The system failed to perform a 0.2 gph (0.76 lph) test in the programmed number of days.	Schedule a 0.2 gph test
PER TST NEEDED WRN	Warning	The system failed to perform a 0.2 gph test in the programmed number of days.	Schedule a 0.2 gph test
PER-LINE TEST FAIL	Alarm	0.2 gph line test failure. (Two consecutive self-test failures.)	Run the 0.2 gph test again. If the system fails, call for service following the procedures established for your site.
PER-LINE SELF FAIL	Alarm	0.2 gph line self-test failure.	Run the 0.2 gph test again. If the system fails, call for service following the procedures established for your site.
PER-PUMP TEST FAIL	Alarm	0.2 gph pumpsided test failure.	Run the 0.2 gph test again. If the system fails, call for service following the procedures established for your site.
PER-PUMP SELF FAIL	Alarm	0.2 gph pumpsided self-test failure.	Run the 0.2 gph test again. If the system fails, call for service following the procedures established for your site.
SELF TEST INVALID	Warning	A self-test failure during a requested test has occurred.	Run the same test again. If the system fails, call for service following the procedures established for your site.
SETUP DATA WARNING	Warning	The default line length was not changed to reflect the actual line length.	Enter the correct line length.
TEST CURRENTLY ON HOLD	None	3.0 gph self-test failure or VLLD PRESSURE WARN alarm.	Retest to validate outcome on next dispense. After 3rd occurrence, system will alarm. After 6th occurrence, system will shut down.
VLLD PRESSURE WARN	Warning	Three consecutive attempts to run a test in which the pressure switch never opened (pump not running).	Call for service following the procedures established for your site.
VLLD PRESSURE ALARM	Alarm	Six consecutive attempts to run a test in which the pressure switch never opened (pump not running).	Call for service following the procedures established for your site.
VLLD SELF TEST FAIL	Alarm	Line Leak Detector hardware failure.	Call for service following the procedures established for your site.

Table 29-13.- Volumetric Line Leak Detector Status Indicators (Continued)

Display Message	Front Panel Indicator	Cause	Action
VLLD TEST FAULT - GRS	Alarm	Line leak detector hardware failure	Call for service following the procedures established for your site.
VLLD TEST FAULT - PER	Alarm	Line leak detector hardware failure	Call for service following the procedures established for your site.
VLLD TEST FAULT - ANN	Alarm	Line leak detector hardware failure	Call for service following the procedures established for your site.

Table 29-14.- Groundwater Sensor Status Indicators

Display Message	Front Panel Indicator	Cause	Action
FUEL ALARM	Alarm	A groundwater sensor in an observation well detects fuel.	Call for service following the procedures established for your site.
WATER OUT ALARM	Warning	Water level is below the float switch making the groundwater sensor ineffective.	Call for service following the procedures established for your site.
SENSOR OUT ALARM	Alarm	The sensor is disconnected or is not functioning properly.	Call for service following the procedures established for your site.
SHORT ALARM	Alarm	An internal short has occurred in the sensor.	Call for service following the procedures established for your site.

Table 29-15.- 2-Wire C.L. Discriminating Interstitial Sensor Status Indicators

Display Message	Front Panel Indicators	Cause	Action
FUEL ALARM	Alarm	A sensor has detected fuel.	Call for service following the procedures established for your site.
WATER ALARM	Warning	A sensor has detected water.	Call for service following the procedures established for your site.
SENSOR OUT ALARM	Alarm	The sensor is disconnected or is not functioning properly.	Call for service following the procedures established for your site.

Table 29-15.- 2-Wire C.L. Discriminating Interstitial Sensor Status Indicators (Continued)

Display Message	Front Panel Indicators	Cause	Action
SHORT ALARM	Alarm	An internal short has occurred in the sensor.	Call for service following the procedures established for your site.

Table 29-16.- 2-Wire C.L. Discriminating Interstitial Micro Sensor Status Indicators

Display Message	Front Panel Indicator	Cause	Action
FUEL ALARM	Alarm	Liquid is present in the area being monitored by the sensor.	Immediately follow the alarm reporting procedures established for your site.
SENSOR OUT ALARM	Alarm	The sensor is disconnected or is not functioning properly.	Sensor problem must be corrected or sensor replaced. Call for service following the procedures established for your site.
		Liquid Sensor setup was performed incorrectly.	Reenter this liquid sensor's setup values.
SHORT ALARM	Alarm	An internal short has occurred in the sensor.	Call for service following the procedures established for your site.

Table 29-17.- 3-Wire C.L. Sensor Status Indicators

Display Message	Front Panel Indicator	Cause	Action
FUEL ALARM	Alarm	A dispenser pan or containment sump sensor has detected fuel.	Call for service following the procedures established for your site.
HIGH LIQUID ALARM	Alarm	A sensor detects a high liquid level.	Call for service following the procedures established for your site.
LIQUID WARNING	Alarm	A sensor detects a small amount of liquid.	Call for service following the procedures established for your site.
SENSOR OUT ALARM	Alarm	The sensor is disconnected or is not functioning properly.	Call for service following the procedures established for your site.
SHORT ALARM	Alarm	An internal short has occurred in the sensor.	Call for service following the procedures established for your site.

Table 29-18.- External Input Messages

Display Message	Front Panel Indicator	Cause	Action
EXTERN INPUT ALARM	Alarm	External device changed from pre-set condition.	Check the operation of the external device.

Table 29-19.- Business Inventory Reconciliation (BIR) Messages*

Display Message	Front Panel Indicator	Cause	Action
CLOSE SHIFT WARNING	Warning	The system is waiting for an idle period to close for a shift report.	System clears itself after idle period and shift closes.
CLOSE DAILY WARNING	Warning	The system is waiting for an idle period to close for a daily shift report.	System clears itself after idle period and shift closes.
COMMUNICATION ALARM	Alarm	No communication between DIM board and an external device.	Call for service following the procedures established for your site.
DISABLED DIM ALARM	Alarm	No communication between ECPU board and DIM board.	Call for service following the procedures established for your site.
PROD THRESH-OLD ALM	Alarm	The variance exceeded the calculated threshold for the period and is evaluated at period end. However, if the Reconciliation Period is rolling, this alarm will be evaluated <u>daily</u> at day close.	Call for service following the procedures established for your site.
TRANSACTION ALARM	Alarm	No transactions received from the Block DIM.	Call for service following the procedures established for your site.

* TLS-350R only

Table 29-20.- Smart Sensor Status Indicators

Display Message	Front Panel Indicator	Cause	Action	
COMMUNICATION ALARM	Alarm	Hardware failure - sensor or interconnecting wiring to console.	Call for service following the procedures established for your site.	
FUEL ALARM	Alarm	Monitored parameter exceeded preset threshold.		
FUEL WARNING	Warning			
WATER WARNING	Warning			
WATER ALARM	Alarm			
HIGH LIQUID WARNING	Warning			
HIGH LIQUID ALARM	Alarm			
INSTALL ALARM	Alarm	Sensor not installed in correct position.		
LOW LIQUID WARNING	Warning	Monitored parameter exceeded preset threshold.		
LOW LIQUID ALARM	Alarm	Monitored parameter exceeded preset threshold.		Call for service following the procedures established for your site.
RELAY ACTIVE	----			
SENSOR FAULT ALARM	Alarm	Mag Sensor - monitored parameter exceeded preset threshold		
		ATM P Sensor - pressure sensor inoperable		
		Vac Sensor - pressure sensor inoperable		
		Vac Float Module - fluid sensor inoperable		
		Relief Valve - valve inoperable		
SENSOR FAULT WARNING	Warning	Vac Sensor Module - vacuum control valve inoperable		
SETUP DATA WARNING	Warning	Programming error	Reprogram sensor	
TEMPERATURE WARNING	Warning	Ambient temperature exceeded sensor's operating range (-40 to +122°F [-40 to +50°C]).	Warning removed when temperature returns to within sensor's operating range.	
NO VACUUM ALARM	Alarm	There is no vacuum in the interstitial space.	Find and repair vacuum leak then perform a Vac Sensor Manual Test (Diag Mode).	
VACUUM WARNING	Warning	There is a leak in the monitored interstitial space. There is a possibility that a No Vacuum alarm will be posted in the future.	Find and repair vacuum leak then perform a Vac Sensor Manual Test (Diag Mode).	

Table 29-21.- Pump Relay Monitor Message

Display Message	Front Panel Indicator	Cause	Action
PUMP RELAY ALARM	Alarm	If pump relay assigned - pump continues to run after it was instructed to stop. If pump relay not assigned - pump continues to run beyond preset delay time.	Call for service following the procedures established for your site.
SETUP DATA WARNING	Warning	Pump relay assigned, but the assigned relay is not configured.	Configure assigned relay or undo it's assignment.

Table 29-22.- VMCI Interface Module Messages*

Display Message	Front Panel Indicator	Cause	Action
SETUP WARN	Warning	More than one VMCI module is installed. The VMCI module in the higher comm port must be removed.	Call for service following the procedures established for your site.
DISABLED VMCI ALARM	Alarm	The VMCI interface module is unresponsive.	Call for service following the procedures established for your site.

*TLS-350/R only

Table 29-23.- VMC (Vapor Monitor Controller) Messages*

Display Message	Front Panel Indicator	Cause	Action
VMC COM TIMEOUT	Alarm	This alarm posts if a VMC is powered off, not connected or the wrong serial number has been entered.	Call for service following the procedures established for your site.
METR NC ALM	Alarm	Dispenser's meter not connected.	Call for service following the procedures established for your site.
FP SHUTDWN WRN	Warning	Fuel position shutdown warning.	Call for service following the procedures established for your site.
FP SHUTDWN ALM	Alarm	Fuel position shutdown alarm.	Call for service following the procedures established for your site.

*TLS-350/R only

Servicing Solid State and Dual Float Discriminating Sensors

Solid State Discriminating and Dual Float Discriminating Sensors, used in dispenser pans and containment sumps, have special service requirements. Should one of these sensors be in an alarm state due to a leak or spill in the containment area, call for service following the recommended procedures for your site.

VLLD Troubleshooting

SELF TEST FAILURE REPORTS

A Self test checks for improper switch conditions throughout the Line Leak test. It also includes a Pumpside Pressure test and Self test (if enabled during setup). If the system fails a Self test while running a Line Leak test, it alarms and displays these messages:

<p>(Date) (Time) P #: LLD SELF TEST FAIL</p>
--

<p>(Date) (Time) P #: LINE LEAK SHUTDOWN</p>
--

The system also prints the test results and disables the submersible pump. For example:

```

LINE LEAK ALARM
SENSOR NUMBER 1
LLD SELF TEST FAIL
P1:UNLEADED REGULAR
MMM DD, YYYY HH:MM XM

LINE LEAK ALARM
SENSOR NUMBER 1
LINE LEAK SHUTDOWN
P1:UNLEADED REGULAR
MMM DD, YYYY HH:MM XM

SUBMERSIBLE PUMP 1
DISABLED
MMM DD, YYYY HH:MM XM

```

To recover from a Self test failure, you need to run the same test you were running when the failure occurred to return the pump to service. If the system fails again, call an authorized Veeder-Root service contractor.

3.0 GPH TEST FAILURE

If the system fails a 3.0 gph (11.3 lph) test during line leak detection, it prints a report of the results and instructs you to perform the Line Verification Procedure (LVP). For example:

```

LINE LEAK ALARM
SENSOR NUMBER 2
LINE LEAK TEST FAIL
P2:UNLEADED SUPER
MMM DD, YYYY HH:MM XM

LINE LEAK ALARM
SENSOR NUMBER 2
LINE LEAK SHUTDOWN
P2:UNLEADED SUPER
MMM DD, YYYY HH:MM XM

SUBMERSIBLE PUMP 2
DISABLED
MMM DD, YYYY HH:MM XM

PERFORM LVP TEST

```

The system also alarms and displays these alarm conditions in Operating Mode:

```

MMM DD, YYYY HH:MM XM
P 2: LINE LEAK TEST FAIL

```

```

MMM DD, YYYY HH:MM XM
P 2: LINE LEAK SHUTDOWN

```

Press ALARM/TEST to silence the alarm. The system displays the message:

```

P #: START LVP TEST
PRESS <ENTER>

```

Press ENTER to start the Line Verification Procedure. The system prints a message to confirm that it has started the test. If the test results in any LLD controller failure, the system goes into Self test failure (see "Self Test Failure Reports" on page 29-19).

If the test results in a failed Line Leak test or Pumpside test, the pump remains disabled until you reenable it by running a successful Self test. If the system fails the Self test again, call an authorized service contractor

If the LVP test is interrupted by the dispenser being on, a lockout time, or an in-tank leak test, the pump is disabled and the system prints out a message that the dispenser is on:

```

LVP TEST INTERRUPTED
UNLEADED SUPER
MMM DD, YYYY HH:MM XM

DISPENSER ON

```

If the LVP test is successful, the pump is enabled and the system prints a message that the test was successful. For example:

```
SUBMERSIBLE PUMP 2
ENABLED
MMM DD, YYYY HH:MM XM

STOP LINE LEAK TEST
P2:UNLEADED SUPER
MMM DD, YYYY HH:MM XM

TEST RESULT = 3.0 GAL/HR
RESULT = PASSED
```

The system prints Final Result reports and leaves the pump disabled if there is a Self test failure. It also disables the pump if the shutdown rate is less than or equal to the Line Leak test failure rate entered during system setup.

PRECISION TEST FAILURE

If the system fails a Precision test, it runs several more tests to verify the leak. The system also prints a report. For example:

```
LINE LEAK ALARM
SENSOR NUMBER 1
LINE LEAK TEST FAIL
P2:UNLEADED REGULAR
MMM DD, YYYY HH:MM XM

LINE LEAK ALARM
SENSOR NUMBER 1
LINE LEAK SHUTDOWN
P1:UNLEADED REGULAR
MMM DD, YYYY HH:MM XM

SUBMERSIBLE PUMP 1
DISABLED
MMM DD, YYYY HH:MM XM
```

Note: The system only prints that the submersible pump is disabled if the pump is shut off.

LEAK VERIFICATION PROCEDURE

If you need to run the Leak Verification Procedure, follow these steps:

1. Press ALARM/TEST to silence the alarm. The system displays the message:

```
START LEAK VERIFICATION
PRESS ENTER
```

2. Prevent the dispenser handles from being lifted. If someone lifts a handle, the system alarms and you will have to begin the procedure again.
3. Press ENTER to begin the Leak Verification Procedure.
4. If the system does detect a leak, follow the procedures established for your site. NOTE: If the system does not detect a leak, it performs a Self test and, if enabled, a Pumpside Pressure test and Self test. If the system fails any of the set tests, call a trained service technician before reenabling the VLLD system.

30 Changing Printer Paper

IMPORTANT! Store regulatory compliance and business documentation including important inventory, alarm, and leak test reports on the paper take-up spool. **Do not discard the paper on the take-up spool unless instructed to do so!**

The system uses Veeder-Root printer paper, part number 514100-210. **Using printing paper other than Veeder-Root's will void the printer warranty.**

To change the paper roll

The paper roll should be changed when a red stripe appears on the printouts.

Swing up the printer cover (1) and push the paper feed release lever (6) down (Figure 30-1). Notice the paper roll (3) and paper feed guide (4). If the take-up spool (2) has been used, pull out the spool with the printed reports and tear off the paper close to the printer feed roller (5).

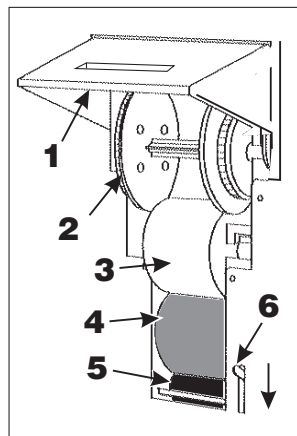

Figure 30-1. Paper change 1

Pull out the take-up spool (2) and separate its two halves by pulling them apart. Remove the printed reports, but do not discard the reports as they may be required later. Pull out the old paper roll (3) and any remaining paper. Remove the roll shaft (7) and press it into the new roll (8). Push the roll (8) into the lower slots in the printer with the paper tail (9) down and at the back.

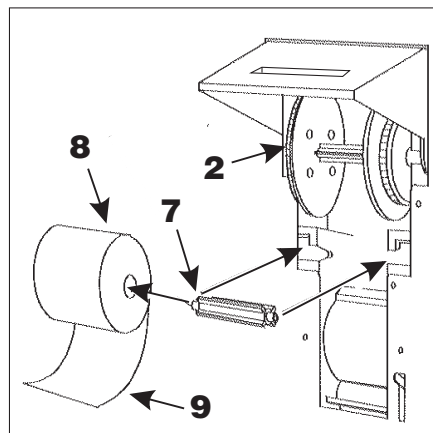

Figure 30-2. Paper change 2

Feed the paper tail (9) over the paper guide (4) and down behind the the paper feed roller (5).

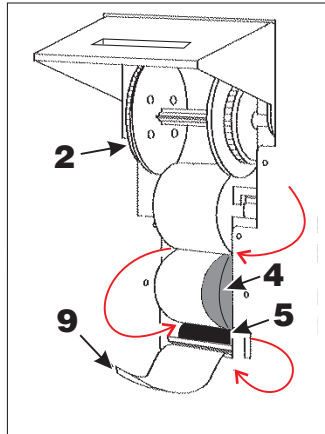

Figure 30-3.Paper change 3

If using the Take-up Spool (2) place the paper tail (9) between the two halves and press them firmly together until you hear a click (Figure 30-4). Push the Take-up Spool (2) into the upper slots. Rotate the spool counterclockwise until you remove all slack in the paper. (If the Take-up Spool is not going to be used, thread the paper tail through the slot (10) in the printer cover.) Push the paper release lever (6) up and close the cover.

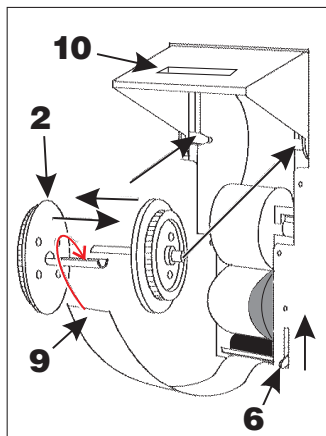

Figure 30-4.Paper change 4

31 System Periodic Maintenance Checklist

Veeder-Root environmental monitoring systems installed in accordance with installation manual requirements are designed to detect and report conditions that inhibit proper operation. Veeder-Root systems self-diagnose essential components, and if a component failure is detected, will not complete and report tank and line tests. The system will issue an audible and visual alarm when a failed or disconnected sensor is detected.

The Periodic Maintenance Checklist, if followed, may extend the life of the system, but is not required for proper operation.

 WARNING	
   	<p>Attempting to service tank monitors and equipment without proper training can be dangerous.</p> <p>Fire or explosion or electrical shock resulting in serious injury or death could result.</p> <p>Read and follow all safety warnings. If you have not been trained in proper service procedures and hazards involved, refer all service to a qualified Veeder-Root Service Representative.</p>

Maintenance Operation	When to Perform	What to Do
Console	Yearly	<ol style="list-style-type: none"> 1. Check printer for paper if equipped. 2. Print out or check system inventory and verify to actual inventory. 3. Print out or record system setup values, then verify if battery backup is working by powering the unit down and then back up with the circuit breaker. If programming is lost, the battery is bad and the unit needs service. 4. Verify in-tank tests are being performed as required by printing reports. 5. Press Alarm/Test button to verify power, warning and alarm indicators light and audible alarm sounds. 6. Verify line leak tests are being performed (if line leak installed).
Mag Probe	Yearly ¹	<p>A. Owner or Station Attendant</p> <ol style="list-style-type: none"> 1. Inspect probe cable for any cracking or damage. <p>B. Service Contractor</p> <ol style="list-style-type: none"> 1. Replace probe cable if cracked or damaged (ref. item A.1). 2. Verify epoxy kits have been installed on field wiring.

31 System Periodic Maintenance Checklist

Maintenance Operation	When to Perform	What to Do
VLLD	Yearly	<p>A. Owner or Station Attendant</p> <ol style="list-style-type: none"> 1. During or immediately after running a 3.0 gph (11.3 lph) selftest, visually inspect the flexible fuel lines for leakage. 2. Check flexible fuel control lines for any chafing or excessive corrosion. <p>B. Service Contractor</p> <ol style="list-style-type: none"> 1. Replace check valve filters (Diesel products only) per VLLD Troubleshooting Manual No. 576013-849. 2. Verify epoxy kits have been installed on field wiring.
PLLD	Yearly	<p>A. Owner or Station Attendant</p> <ol style="list-style-type: none"> 1. Check submersible pump head for leakage at PLLD transducer port and functional element with pump On. 2. Check PLLD transducer cable for any cracking or damage. <p>B. Service Contractor</p> <ol style="list-style-type: none"> 1. Verify epoxy kits have been installed on field wiring. 2. Replace PLLD transducer if cable is cracked or damaged (ref. item A.2).
WPLLD	Yearly	<p>Owner or Station Attendant</p> <p>Check submersible pump head for leakage at WPLLD transducer port and functional element with pump ON.</p>
Dispenser Pan, Containment Sump, and Piping Sump Sensor (float type)	Yearly	<p>A. Owner or Station Attendant</p> <ol style="list-style-type: none"> 1. Inspect sensors to verify float moves freely. 2. Turn sensor upside down to verify the monitor liquid alarm is activated. 3. Inspect sensor cable for any cracking or damage. <p>B. Service Contractor</p> <ol style="list-style-type: none"> 1. Verify epoxy kits have been installed on field wiring. 2. Replace Dispenser Pan/Containment Sump sensor cables if cracked or damaged. Replace Piping Sump sensor if cable is cracked or damaged (ref. item A.3).

31 System Periodic Maintenance Checklist

Maintenance Operation	When to Perform	What to Do
Dispenser Pan Sensor (Solid-State)	Yearly	<p>A. Owner or Station Attendant</p> <ol style="list-style-type: none"> 1. Inspect sensor cable for any cracking or damage. 2. Verify sensor is firmly secured in an upright position on the bottom of the pan. <p>B. Service Contractor</p> <ol style="list-style-type: none"> 1. Verify epoxy kits have been installed on field wiring. 2. Replace sensor cable if cracked or damaged (ref. item A.1).
Containment Sump Sensor (Solid-State)	Yearly	<p>A. Owner or Station Attendant</p> <ol style="list-style-type: none"> 1. Inspect sensor cable for any cracking or damage. 2. Verify sensor is firmly secured in an upright position on the bottom of the containment sump. <p>B. Service Contractor</p> <ol style="list-style-type: none"> 1. Verify epoxy kits have been installed on field wiring. 2. Replace sensor cable if cracked or damaged (ref. item A.1).
Vapor Sensor	Yearly	<p>A. Owner or Station Attendant</p> <ol style="list-style-type: none"> 1. Inspect sensor cable for any cracking or damage. <p>B. Service Contractor</p> <ol style="list-style-type: none"> 1. Verify epoxy kits have been installed on field wiring. 2. Replace sensor if sensor is cracked or damaged (ref. item A.1).
Groundwater Sensor	Yearly	<p>A. Owner or Station Attendant</p> <ol style="list-style-type: none"> 1. Inspect sensor cable for any cracking or damage. 2. Lift sensor above water level in the well and verify the system activates a "WATER OUT" alarm. <p>B. Service Contractor</p> <ol style="list-style-type: none"> 1. Verify epoxy kits have been installed on field wiring. 2. Replace sensor if cable is cracked or damaged (ref. item A.1). 3. If the sensor does not alarm (ref. item A.2), replace the sensor.

31 System Periodic Maintenance Checklist

Maintenance Operation	When to Perform	What to Do
Hydrostatic Sensor	Yearly	<p>A. Owner or Station Attendant</p> <ol style="list-style-type: none"> 1. Inspect sensor cable for any cracking or damage. <p>B. Service Contractor</p> <ol style="list-style-type: none"> 1. Remove sensor from brine reservoir and verify floats move freely. With sensor in its upright position, the system should activate a "FUEL ALARM". Turn the sensor upside down to be sure the system activates a "WATER ALARM". If the sensor does not alarm in both conditions, replace the sensor. 2. Verify epoxy kits have been installed on field wiring. 3. Replace sensor if cable is cracked or damaged (ref. item A.1).
Mag Sensor	Yearly	<p>A. Owner or Station Attendant</p> <ol style="list-style-type: none"> 1. Inspect sensor cable for any cracking or damage. 2. Check that sensor is resting firmly on bottom of monitored pan/sump. <p>B. Service Contractor</p> <ol style="list-style-type: none"> 1. Replace Mag Sensor cable if cracked or damaged (ref. item A.1). 2. Verify epoxy kits have been installed on field wiring.
Vacuum Sensor	Yearly	<p>A. Owner or Station Attendant</p> <ol style="list-style-type: none"> 1. Inspect cables for any cracking or damage. 2. Check vacuum tubing and fittings connecting Vac system components for signs of wear or poor fit. Tubing should be free of kinks and be pliable. <p>B. Service Contractor</p> <ol style="list-style-type: none"> 1. Replace Vac Sensor cable if cracked or damaged. Replace Vac Float module cable if cracked or damaged (ref. item A.1) 2. Replace damaged tubing/fittings as required (ref. item A.2). 3. Verify epoxy kits have been installed on field wiring.

32 Maintenance Report - TLS-350 Only

The Maintenance Report feature is available in the TLS-350 with version 27 software and a NVMEM 203 card installed. Maintenance History must be enabled in System Setup for this feature to function. To access the Maintenance Report menu, press the white key on the front panel left keypad (see Figure 32-1).

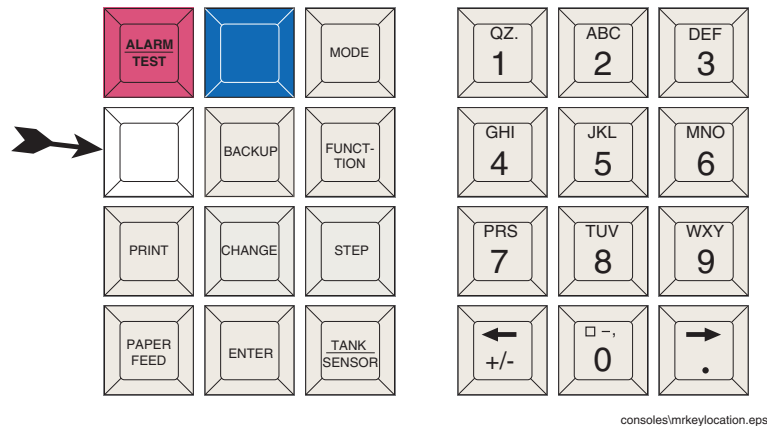

Figure 32-1. Maintenance Report key on front panel

Maintenance Report

MAINTENANCE HISTORY - TLS-350 ONLY

Contains a rolling 3 year history of the following maintenance records:

- Active Alarm (alarm post) – alarm type and number, device number, active date/time. This includes protected maintenance alarms.
- Inactive Alarm (alarm clear) – alarm type and number, device number, inactive date/time. This includes protected maintenance alarms.
- Maintenance History enable - date/time of enable
- Maintenance History disable –date/time of disable
- Service codes – service code, date/time entered (Note: Service codes can be found in the Maintenance Service Code Quick Help (P/N 577013-874)
- Last Monthly Fullest Periodic Tank Test Passed – tank number, start date/time
- Last Monthly PLLD 0.2 GPH Test Passed – tank number, date/time entered (record added at 1st of month)
- Last Monthly WLLD 0.2 GPH Test Passed – tank number, date/time entered (record added at 1st of month)
- Last Monthly VLLD 0.2 GPH Test Passed – tank number, date/time entered (record added at 1st of month)

Printing Out the Maintenance Report

Press the white (Maintenance Report) key on the front panel (Maintenance history or Maintenance Tracker must be enabled to access this menu:

MAINTENANCE REPORT
PRESS <PRINT>

Press Print to print the default number of records (20), starting from the default (current) date (see example in Figure 32-2):

```

STATION HEADER 1
STATION HEADER 2
STATION HEADER 3
STATION HEADER 4

MMM DD, YYYY HH:MM XM

MAINTENANCE HISTORY
-----
LOGOUT MM/DD/YY HH:MM
J Smith A12345
SVC CODEMM/DD/YY HH:MM
REMOVE LQD XXXX
REWired SENSOR YYYY
  ALM ACK MM/DD/YY HH:MM
L12: SENSOR OUT ALARM
  CLEAR MM/DD/YY HH:MM
L 12: SENSOR OUT ALARM
L 1: SENSOR OUT ALARM
  LOGIN MM-DD-YY HH:MM
J Smith A12345
ALM CLR MM-DD-YY HH:MM

```

Figure 32-2. Maintenance Report printout example

NEXT 20 RECORDS
PRESS <PRINT>

Press Print to print (up to) the next 20 records, or Step to return to the main screen:

MMM DD, YYYY HH:MM XM
ALL FUNCTIONS NORMAL

To Print Specific Maintenance Records

Press the white (Maintenance Report) key on the front panel:

**MAINTENANCE REPORT
PRESS <PRINT>**

Press Step:

**MAINT REPORT PRINT
START DATE: MM/DD/YY**

Press Change and enter the start date of the records you want to print:

**MAINT REPORT PRINT
START DATE: MM/DD/YY**

Press Enter:

**START DATE: MM/DD/YY
PRESS <STEP>**

Press Step:

**MAINT REPORT PRINT
NUMBER OF RECORDS: 20**

Press Enter to accept the default number (20), or Change to enter up to the maximum of 70 (per print request).
Previous records are selectable from a rolling 3 year period:

**MAINT REPORT PRINT
NUMBER OF RECORDS: 70**

Press Enter:

**NUMBER OF RECORDS: 70
PRESS <STEP>**

Press Step:

**MAINT REPORT PRINT
PRESS <PRINT>**

Press Print:

**NEXT 70 RECORDS
PRESS <PRINT>**

Press Print to print the next 70 records, or Step to return to the operator menu:

**MMM DD, YYYY HH:MM XM
ALL FUNCTIONS NORMAL**

The Print key can be pressed until all of the records have been printed, at which point the console will automatically return to the operator (ALL FUNCTIONS NORMAL) menu. The start date and the number of records (to print) return to the default values when exiting this menu.

33 Maintenance Tracker - TLS-350 Only

The Maintenance Tracker feature is available in the TLS-350 with version 27 software, a NVMEM 203 card, and a MT Comm card installed. The blue key on the front panel left keypad (see Figure 33-1) accesses the Maintenance Tracker menu.

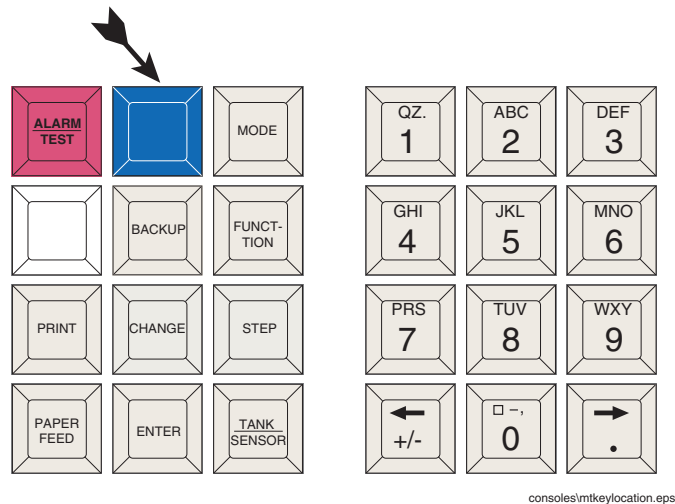

Figure 33-1. Maintenance Tracker key on front panel

Using Maintenance Tracker

1. Perform any required site work.
2. Initialize Maintenance Tracker (you should have your ID key ready to plug into the MT Comm card in the Comm Bay of the TLS-350).

Press the blue key on the front panel. The display will read 'Disabled' or 'Enabled'.

**MAINTENANCE TRACKER
DISABLED**

- 'Disabled' appears the very first time Maintenance Tracker is accessed.
- 'Enabled' appears thereafter.

Press Step and the display will read.

**INSERT KEY IN PORT
PRESS <ENTER>**

You have one minute to plug your ID key into the MT Comm card and press Enter, or the system will timeout (and return to the operating mode main screen):

**MMM DD, YYYY HH:MM XM
ALL FUNCTIONS NORMAL**

A valid key inserted within one minute following the key insertion prompt will display:

```
MAINTENANCE TRACKER
LOGGED IN XXXXXX
```

Where XXXXXX is your Contractor's ID number. Note: If your key is not accepted the display will read:

- KEY EXPIRED (your TLS certification has expired),
- KEY BLOCKED (your key has been blocked),
- KEY INVALID (for some reason your key cannot be acknowledged by the system), or
- LOG-IN RECORD ERROR - key was read but system was unable to write a log-in record to FEPROM - (this usually a problem with the console system date/time).

Press any key to display the operating mode main screen:

```
MMM DD, YYYY HH:MM XM
ALL FUNCTIONS NORMAL
```

3. Acknowledge any protected alarms.
4. Enter Service Code(s) for completed site work as follows.
 - a. Press Mode key until you display:

```
DIAG MODE
PRESS <FUNCTION> TO CONT
```

- a. Press Function until you see:

```
SERVICE REPORT
PRESS <STEP> TO CONT
```

- b. Press Step:

```
SERVICE CODE LIST
PRESS <PRINT>
```

Press Print to print out a list of all predefined and previously entered User Defined (99xx) service codes. (you can also refer to the Maintenance Service Codes Quick Help guide [P/N577013-874] for a list of the predefined codes.)

- c. Press Step:

```
ENTER SERVICE CODE
CODE:
```

Press Change and enter the 4-digit service code for the work performed. If this is a User defined service code, use 99xx, where xx is a number from 01 to 99.

- d. Press Enter:

```
CODE: XXXX
PRESS <STEP> TO CONTINUE
```

- e. Press Step:

```
ENTER SERVICE CODE LABEL
LBL:
```

Press Change and enter a label for the new service code.

These displays do not appear when entering a predefined service code.

- f. Press Enter to add the new service code to the Maintenance Record:

**LBL: (service code label)
PRESS <STEP> TO CONTINUE**

- g. Press Step:

**ENTER SERVICE CODE
CODE:**

Repeat the above steps (c - d) to enter additional service codes as required.

5. when all codes are entered for this work session, remove your Contractor's ID key.

