



Encore® and Eclipse®

Site Preparation Manual

Computer Programs and Documentation

All Gilbarco Inc. and/or Veeder-Root Company computer programs (including software on diskettes and within memory chips) and documentation are copyrighted by, and shall remain the property of, Gilbarco Inc. and/or Veeder-Root Company. Such computer programs and documents may also contain trade secret information. The duplication, disclosure, modification, or unauthorized use of computer programs or documentation is strictly prohibited, unless otherwise licensed by Gilbarco Inc. and/or Veeder-Root Company.

Federal Communications Commission (FCC) Warning

This equipment has been tested and found to comply with the limits for a Class A digital device pursuant to Part 15 of the FCC Rules. These limits are designed to provide reasonable protection against harmful interference when the equipment is operated in a commercial environment. This equipment generates, uses, and can radiate radio frequency energy, and if not installed and used in accordance with the instruction manual, may cause harmful interference to radio communications. Operation of this equipment in a residential area is likely to cause harmful interference in which case the user will be required to correct the interference at his own expense. Changes or modifications not expressly approved by the manufacturer could void the user's authority to operate this equipment.

Approvals

Gilbarco is an ISO 9001:2008 registered company.

Underwriters Laboratories (UL):

UL File#	Products listed with UL
MH1941	All Gilbarco pumps and dispensers that bear the UL listing mark.
MH8467	Transac System 1000 and PAM 1000
E105106	Dell DHM Minitower
E165027	G-SITE and Passport Systems

California Air Resources Board (CARB):

Executive Order #	Product
G-70-52-AM	Balance Vapor Recovery
G-70-150-AE	VaporVac

National Conference of Weights and Measures (NCWM) - Certificate of Conformance (CoC):

Gilbarco pumps and dispensers are evaluated by NCWM under the National Type Evaluation Program (NTEP). NCWM has issued the following CoC:

CoC#	Product	Model #	CoC#	Product	Model #
02-019	Encore	Nxx	02-036	Legacy	Jxxx
02-020	Eclipse	Exx	02-037	G-SITE Printer (Epson)	PA0307
02-025	Meter - C Series	PA024NC10		G-SITE Distribution Box	PA0306
	Meter - C Series	PA024TC10		G-SITE Keyboard	PA0304
02-029	CRIND	—		G-SITE Mini Tower	PA0301
	TS-1000 Console	—		G-SITE Monitor	PA0303
	TS-1000 Controller	PA0241	G-SITE Printer (Citizen)	PA0308	
02-030	Distribution Box	PA0242	02-038	C+ Meter	T19976
	Meter - EC Series	PA024EC10	02-039	Passport	PA0324
	VaporVac Kits	CV	02-040	Ecometer	T20453
			05-001	Titan	KXXY Series

Trademarks

Non-registered trademarks

Applause™ Media System	G-SITE® Lite™	SMARTConnect™	ValueLine™
CIM™	Highline™	SMART CRIND™	
C-PAM™	Horizon™	SMART Meter™	
Ecometer™	Insite360™	SmartPad™	
ECR™	MultiLine™	Super-Hi™	
EMC™	Optimum™ Series	Surge Management System™	
FlexPay™	PAM™	Tank Monitor™	
G-CAT™	PAM™ 1000	TCR™	
Gilbert™	PAM™ 5000	Titan™	
G-SITE® Link™	Passport™	Ultra-Hi™	

Registered trademarks

CRIND®	Making Things Better®
Dimension® Series	MPD®
e-CRIND®	Performer®
Eclipse®	The Advantage® Series
Encore®	Transac®
G-SITE®	Transac® System 1000
Gilbarco®	Trimline®
InfoScreen®	TRIND®
Legacy®	VaporVac®

Service mark

GOLDSM

Additional US and foreign trademarks pending.

Other brand or product names shown may be trademarks or registered trademarks of their respective holders.

Table of Contents

1 – Introduction	1-1
Purpose	1-1
Intended Users	1-1
Gilbarco Contact Information	1-1
Required Reading	1-2
Related Documents	1-2
Abbreviations and Acronyms	1-3
Common Terms	1-4
Other Useful Safety Information	1-5
Breakaways	1-5
Collection of Fuel in Approved Containers	1-5
Read Material Safety Data Sheets (MSDS)	1-5
Replacement Parts	1-5
Fluid Compatibility	1-5
2 – Important Safety Information	2-1
3 – Site Preparation	3-1
Station Layout	3-1
Americans with Disabilities Act (ADA) Requirements	3-2
Station Security	3-3
Enhancing Security	3-3
Equipment and Materials Required at Site	3-4
4 – Electrical Requirements	4-1
Emergency Power Cutoff Switch	4-1
Circuit Breakers	4-2
STP Control Relay Boxes for Dispensers	4-3
STP Isolation Relays for Electronic Dispensers	4-3
Conduit	4-3
Wiring	4-4
Data Wire Lengths	4-5
High-speed Communication Wiring	4-6
Auxiliary Conduit	4-7
Ethernet Cable	4-7
Ethernet Cable Installation Personnel and Procedures	4-7
Grounding	4-8
Sealing ‘Y’ Fittings	4-9
5 – Plumbing Requirements	5-1
Fuel Tanks	5-1
Fluid Handling Components for DEF	5-2
Recommended Hose Material for DEF	5-2
Skid Mounted Tanks for DEF Dispensers	5-2
Leak Detectors	5-2
STPs	5-3
Important Considerations for Sizing STPs	5-3

Table of Contents

Pipe Installation5-3
 Acceptable Pipe Material for DEF5-4
 Pipe Size5-4
Check Valves (Used on Pumps and Ultra-Hi Units Only)5-5
Shear Valves (Generally Used on Dispensers Only)5-6
Encore Ultra-Hi Shear Valve Installation Notes5-8
Mounting Pit Box5-8
Safety Signs5-9

Index Index-1

1 – Introduction

Purpose

The manual provides information to prepare a site for Encore® and Eclipse® series pumps or dispensers.

Intended Users

This manual is intended for individuals who are trained in the construction of gasoline stations. If you do not have experience with this type of construction (gasoline stations), contact a licensed, trained engineer, contractor, or Gilbarco® Authorized Service Contractor (ASC).

Gilbarco Contact Information

Information	Contact
Schedule training on Gilbarco products	Local Gilbarco distributor.
Technical assistance	Gilbarco Technical Support at 1-800-743-7501.
Warranty service and information	Gilbarco Service Center at 1-800-800-7498.
Explanation of Gilbarco's warranty policy	Local Gilbarco distributor.
Additional technical literature, for example, installation, parts manuals, and other documents	Gilbarco Online Documentation (GOLD SM) www.gilbarco.com/interactive/login.cfm
Solutions, Products, Services, and Support	www.gilbarco.com

Required Reading



Before installing, the installer must read, understand, and follow:

- This manual
- National Fire Protection Association (NFPA) 30A, The Automotive and Marine Service Station Code
- NFPA 70®, The National Electrical Code (NEC®)
- Applicable federal, state, and local codes and regulations

Failure to do so may adversely affect the safe use and operation of the equipment.

Note: Installations must be performed by a Gilbarco ASC to ensure warranty.

For additional information, refer to manufacturer's installation instructions. Equipment manufacturers must provide instructions for other equipment, such as Submersible Turbine Pumps (STPs), leak detectors, underground tanks, product lines, and shear valves. Gilbarco does not provide complete or up-to-date installation instructions for other manufacturer's equipment

Perform all site preparation procedures in accordance with NFPA 30A, NFPA 70, and applicable national, state, and local codes/regulations. For a non-US installation, other codes may apply. Plan your site ahead of time. Use experienced, licensed personnel that practice accurate, safe construction techniques. Time, expense, and extra effort in the early stages of preparing a site can eliminate problems in later stages.

Related Documents

Document Number	Title	GOLD Library
FE-321	Gilbarco STP Isolation Relay Box PA0287 120 VAC	Field Wiring Diagrams
FE-341	Field Wiring Diagram Eclipse Series Dispensers	<ul style="list-style-type: none"> • Encore and Eclipse • Encore and Eclipse Installer
FE-363	Field Wiring Diagram Encore 500/700/900 (M07555 Power Supply Only)	Encore and Eclipse
FE-364	Field Wiring Diagram Encore 300	Encore and Eclipse
MDE-2540	The Advantage®, Legacy®, and MPD® Series Owner's Manual	Advantage and Legacy Models
MDE-2755	STP Control and Dispenser Isolation Relay Box (PA0287)	<ul style="list-style-type: none"> • Encore and Eclipse • Advantage and Legacy Models • Encore and Eclipse Installers
MDE-3187	K94227-XX, K94229-XX and K96576-01 Shear Valve Mounting Kit for Vapor Recovery Lines Installation Instructions	Advantage and Legacy Models
MDE-3804	Encore and Eclipse Start-up/Service Manual	<ul style="list-style-type: none"> • Encore and Eclipse • Service Manual
MDE-3893	Encore and Eclipse Series Owner's Manual	<ul style="list-style-type: none"> • Encore and Eclipse • Encore and Eclipse Installers
MDE-3984	Encore, Legacy, and Titan™ Dispenser and Related Products Limited Warranty for USA and Canada	Domestic Warranty and Owner's Manuals
MDE-3985	Encore Installation Manual	<ul style="list-style-type: none"> • Encore and Eclipse • Encore and Eclipse Installers
MDE-4185	CRIND® Encore 700 S Electronics CRIND BIOS Configuration Interface Manual	• CRIND and TRIND®
MDE-4699	Applause™ Media System Installation, Service, and Parts Manual	<ul style="list-style-type: none"> • SMARTConnect™ • Encore and Eclipse

Document Number	Title	GOLD Library
MDE-4902	Encore 700 S Start-up and Service Manual	<ul style="list-style-type: none"> Encore and Eclipse CRIND and TRIND
MDE-5356	Encore 900 Start-up and Service Manual	<ul style="list-style-type: none"> Encore and Eclipse Service Manual
PT-1936	Encore Series Pumps and Dispensers Illustrated Parts Manual	<ul style="list-style-type: none"> Parts Manual Encore and Eclipse Encore and Eclipse Installers
PT-1937	Encore 300, Encore 500/500 S, Encore 550, Encore 700 S, Eclipse Recommended Spare Parts Manual	<ul style="list-style-type: none"> Parts Manual Encore and Eclipse
PT-1969	Encore 900 Pump and Dispenser Illustrated Parts Manual	<ul style="list-style-type: none"> Parts Manual Encore and Eclipse Encore and Eclipse Installers

Abbreviations and Acronyms

Term	Description
ADA	Americans with Disabilities Act
ANSI	American National Standards Institute
API	Application Programming Interface
ASC	Authorized Service Contractor
BIOS	Basic Input/Output System
BRCM	Back Room Communication Module
CAT5	Category 5
CEC	Canadian Electrical Code
CoC	Certification of Conformance
CRIND	Card Reader in Dispenser
D-Box	Distribution Box
DEF	Diesel Exhaust Fluid
EIA	Energy Information Administration
EPA	Environmental Protection Agency
FCC	Federal Communications Commission
GFI	Ground Fault Interrupt
GLRE	Gilbarco Long Range Ethernet®
GOLD	Gilbarco Online Documentation
HDPE	High Density Polyethylene
IEEE	Institute of Electrical and Electronics Engineers
J-box	Junction Box
LAN	Local Area Network
LRE	Long-reach Ethernet
MPD	Multi-product Dispenser
MSDS	Material Safety Data Sheets
MTW	Machine Tool Wire
NEC	National Electrical Code
NFPA	National Fire Protection Association
OSHA	Occupational Safety and Health Administration

Term	Description
PEI	Petroleum Equipment Institute
POS	Point of Sale
PVC	Polyvinyl Chloride
RFID	Radio Frequency Identifier Device
STP	Submersible Turbine Pump
TFFN	Thermoplastic Flexible Fixture Wire Nylon Jacketed
TIA	Telecommunications Industry Association
TRIND	Transmitter/Receiver in Dispenser
TSB	Telecommunications System Bulletin
UL®	Underwriters Laboratories
ULSD	Ultra Low Sulfur Diesel
UTP	Unshielded Twisted-Pair

Common Terms

Term	Description
Alternative Fuels	Fuels other than standard gasoline or diesel that may contain high alcohol content. For example, E85, bio-diesel, special additives, or special fuel mixes.
Biodiesel	Diesel fuel consisting of long-chain alkyl (methyl, propyl or ethyl) esters, which can be used as fuel in standard diesel engines.
CAT5 Cable	Category 5 (CAT5) Cable is a twisted pair cable for carrying signals used in structured cabling for computer networks such as Ethernet.
CoC	Certificate of Conformance (CoC) (see backside of the front cover for listing of numbers).
Daisy-chain Communications Wiring	Series method of wiring is called daisy chaining.
DEF	Clear, colorless, non-toxic, non-flammable, non-combustible liquid. It is made up of 32.5% urea with the balance distilled or deionized water. Urea and water are completely miscible and do not separate in storage. Diesel Exhaust Fluid (DEF) is mildly corrosive.
Dispenser	Dispensing device that uses STP in storage tank to move fuel from storage tank to dispenser.
E85	An ethanol fuel blend up to 85% denatured ethanol fuel and gasoline or other hydrocarbon by volume.
High Hose	Pumps/dispensers with hoses that connect overhead.
Junction Box	Is a container for electrical connections, usually intended to conceal them from sight and deter tampering.
Listed	Products that bear the authorized listing mark of Underwriters Laboratories (UL). This is the manufacturer's declaration that the product complies with UL's requirements in accordance with the terms of UL's listing and follow-up service agreement.
Low Hose	Pumps/dispensers with hoses that connect at hydraulics level.
Master/Satellite	Master dispensers are teamed with satellites for rapid fueling of trucks with saddle tanks. The master unit meters and computes product flow for both units. The satellite is a dispenser without the electronics module.
NFPA	National Fire Protection Association (NFPA), an international nonprofit organization, to reduce the worldwide burden of fire and other hazards on the quality of life by providing and advocating consensus codes and standards, research, training, and education.
Pump	Uses self-contained pumping unit and motor to move fuel from storage tank.
Valves	Mechanical device by which the flow of fuel in bulk may be started, stopped, or regulated by a movable part that opens, shuts, or partially obstructs one or more ports or passage ways.

Other Useful Safety Information

This section provides additional safety information.

Breakaways

Required by NFPA 30A, breakaways are emergency devices designed to retain liquid on both sides of the breakaway point installed on each hose. For proper installation, refer to manufacturer's instructions.

Collection of Fuel in Approved Containers

NFPA 30A, Section 2, requires use of approved containers to collect, transport, and dispose of fuel. Containers must be specifically designed and labeled for handling hazardous fuels.

Read Material Safety Data Sheets (MSDS)



Before working with any chemicals or fuels in and around a dispensing facility, read the MSDS pertaining to those chemicals as prescribed in the Occupational Safety and Health Administration (OSHA) Standard, 29 CFR 1910.1200. Refer also to supplier's literature.

Replacement Parts

Use only genuine Gilbarco replacement parts and retrofits on your pump/dispenser. Using parts other than genuine Gilbarco replacement parts could create a safety hazard and violate local regulations.

For replacement parts, ensure to match the component ratings for the fluid being dispensed. Use the flexible fuel-compatible parts for valves, meters, filters, outlet castings, O-rings, and in some cases, protected piping. Flexible fuel components utilize plated, coated, and flexible fuel-resistant elastomers.

Fluid Compatibility

The equipment and plumbing used in the dispensers must be compatible with the fuel that will be dispensed. Use of equipment and plumbing that is not compatible with the fuel could cause fuel leaks. For example, E85, high percentages of biodiesel, and DEF are the fuels or fluids that require special dispensers.

This page is intentionally left blank.

2 – Important Safety Information

Notes: 1) Save this Important Safety Information section in a readily accessible location.

2) Although DEF is non-flammable, Diesel is flammable. Therefore, for DEF cabinets that are attached to Diesel dispensers, follow all the notes in this section that pertain to flammable fuels.



This section introduces the hazards and safety precautions associated with installing, inspecting, maintaining or servicing this product. Before performing any task on this product, read this safety information and the applicable sections in this manual, where additional hazards and safety precautions for your task will be found. Fire, explosion, electrical shock or pressure release could occur and cause death or serious injury, if these safe service procedures are not followed.

Preliminary Precautions

You are working in a potentially dangerous environment of flammable fuels, vapors, and high voltage or pressures. Only trained or authorized individuals knowledgeable in the related procedures should install, inspect, maintain or service this equipment.

Emergency Total Electrical Shut-Off

The first and most important information you must know is how to stop all fuel flow to the pump/dispenser and island. Locate the switch or circuit breakers that shut off all power to all fueling equipment, dispensing devices, and Submerged Turbine Pumps (STPs).

 WARNING	
	The EMERGENCY STOP, ALL STOP, and PUMP STOP buttons at the cashier's station WILL NOT shut off electrical power to the pump/dispenser. This means that even if you activate these stops, fuel may continue to flow uncontrolled.
	
	You must use the TOTAL ELECTRICAL SHUT-OFF in the case of an emergency and not the console's ALL STOP and PUMP STOP or similar keys.

Total Electrical Shut-Off Before Access

Any procedure that requires access to electrical components or the electronics of the dispenser requires total electrical shut off of that unit. Understand the function and location of this switch or circuit breaker before inspecting, installing, maintaining, or servicing Gilbarco equipment.

Evacuating, Barricading and Shutting Off

Any procedure that requires access to the pump/dispenser or STPs requires the following actions:



- An evacuation of all unauthorized persons and vehicles from the work area
- Use of safety tape, cones or barricades at the affected unit(s)
- A total electrical shut-off of the affected unit(s)

Read the Manual

Read, understand and follow this manual and any other labels or related materials supplied with this equipment. If you do not understand a procedure, call the Gilbarco Support Center at 1-800-800-7498. It is imperative to your safety and the safety of others to understand the procedures before beginning work.

Follow the Regulations

Applicable information is available in National Fire Protection Association (NFPA) 30A; *Code for Motor Fuel Dispensing Facilities and Repair Garages*, NFPA 70; *National Electrical Code (NEC)*, Occupational Safety and Health Administration (OSHA) regulations and federal, state, and local codes. All these regulations must be followed. Failure to install, inspect, maintain or service this equipment in accordance with these codes, regulations and standards may lead to legal citations with penalties or affect the safe use and operation of the equipment.

Replacement Parts

Use only genuine Gilbarco replacement parts and retrofit kits on your pump/dispenser. Using parts other than genuine Gilbarco replacement parts could create a safety hazard and violate local regulations.

Safety Symbols and Warning Words

This section provides important information about warning symbols and boxes.

Alert Symbol



This safety alert symbol is used in this manual and on warning labels to alert you to a precaution which must be followed to prevent potential personal safety hazards. Obey safety directives that follow this symbol to avoid possible injury or death.

Signal Words

These signal words used in this manual and on warning labels tell you the seriousness of particular safety hazards. The precautions below must be followed to prevent death, injury or damage to the equipment:



DANGER: Alerts you to a hazard or unsafe practice which will result in death or serious injury.



WARNING: Alerts you to a hazard or unsafe practice that could result in death or serious injury.



CAUTION with Alert symbol: Designates a hazard or unsafe practice which may result in minor injury.

CAUTION without Alert symbol: Designates a hazard or unsafe practice which may result in property or equipment damage.

Working With Fuels and Electrical Energy

Prevent Explosions and Fires

Fuels and their vapors will explode or burn, if ignited. Spilled or leaking fuels cause vapors. Even filling customer tanks will cause potentially dangerous vapors in the vicinity of the dispenser or island.

DEF is non-flammable. Therefore, explosion and fire safety warnings do not apply to DEF fluid lines.

Important Safety Information

No Open Fire



Open flames from matches, lighters, welding torches or other sources can ignite fuels and their vapors.

No Sparks - No Smoking



Sparks from starting vehicles, starting or using power tools, burning cigarettes, cigars or pipes can also ignite fuels and their vapors. Static electricity, including an electrostatic charge on your body, can cause a spark sufficient to ignite fuel vapors. Every time you get out of a vehicle, touch the metal of your vehicle, to discharge any electrostatic charge before you approach the dispenser island.

Working Alone

It is highly recommended that someone who is capable of rendering first aid be present during servicing. Familiarize yourself with Cardiopulmonary Resuscitation (CPR) methods, if you work with or around high voltages. This information is available from the American Red Cross. Always advise the station personnel about where you will be working, and caution them not to activate power while you are working on the equipment. Use the OSHA Lockout/Tagout procedures. If you are not familiar with this requirement, refer to this information in the service manual and OSHA documentation.

Working With Electricity Safely

Ensure that you use safe and established practices in working with electrical devices. Poorly wired devices may cause a fire, explosion or electrical shock. Ensure that grounding connections are properly made. Take care that sealing devices and compounds are in place. Ensure that you do not pinch wires when replacing covers. Follow OSHA Lockout/Tagout requirements. Station employees and service contractors need to understand and comply with this program completely to ensure safety while the equipment is down.

Hazardous Materials

Some materials present inside electronic enclosures may present a health hazard if not handled correctly. Ensure that you clean hands after handling equipment. Do not place any equipment in the mouth.

WARNING

The pump/dispenser contains a chemical known to the State of California to cause cancer.

WARNING

The pump/dispenser contains a chemical known to the State of California to cause birth defects or other reproductive harm.



Gilbarco Veeder-Root encourages the recycling of our products. Some products contain electronics, batteries, or other materials that may require special management practices depending on your location. Please refer to your local, state, or country regulations for these requirements.

In an Emergency

Inform Emergency Personnel

Compile the following information and inform emergency personnel:

- Location of accident (for example, address, front/back of building, and so on)
- Nature of accident (for example, possible heart attack, run over by car, burns, and so on)
- Age of victim (for example, baby, teenager, middle-age, elderly)
- Whether or not victim has received first aid (for example, stopped bleeding by pressure, and so on)
- Whether or not a victim has vomited (for example, if swallowed or inhaled something, and so on)

WARNING



Gasoline/DEF ingested may cause unconsciousness and burns to internal organs. Do not induce vomiting. Keep airway open. Oxygen may be needed at scene. Seek medical advice immediately.

WARNING

DEF generates ammonia gas at higher temperatures. When opening enclosed panels, allow the unit to air out to avoid breathing vapors. If respiratory difficulties develop, move victim away from source of exposure and into fresh air. If symptoms persist, seek medical attention.

WARNING



Gasoline inhaled may cause unconsciousness and burns to lips, mouth and lungs. Keep airway open. Seek medical advice immediately.

WARNING



Gasoline/DEF spilled in eyes may cause burns to eye tissue. Irrigate eyes with water for approximately 15 minutes. Seek medical advice immediately.

WARNING



Gasoline/DEF spilled on skin may cause burns. Wash area thoroughly with clear water. Seek medical advice immediately.

WARNING



DEF is mildly corrosive. Avoid contact with eyes, skin, and clothing. Ensure that eyewash stations and safety showers are close to the work location. Seek medical advice/recommended treatment if DEF spills into eyes.

IMPORTANT: Oxygen may be needed at scene if gasoline has been ingested or inhaled. Seek medical advice immediately.

Lockout/Tagout

Lockout/Tagout covers servicing and maintenance of machines and equipment in which the unexpected energization or start-up of the machine(s) or equipment or release of stored energy could cause injury to employees or personnel. Lockout/Tagout applies to all mechanical, hydraulic, chemical, or other energy, but does not cover electrical hazards. Subpart S of 29 CFR Part 1910 - Electrical Hazards, 29 CFR Part 1910.333 contains specific Lockout/Tagout provision for electrical hazards.

Hazards and Actions

 WARNING	
	Spilled fuels, accidents involving pumps/dispensers, or uncontrolled fuel flow create a serious hazard.
	Fire or explosion may result, causing serious injury or death. Follow established emergency procedures. DEF is non-flammable. However it can create a slip hazard. Clean up spills promptly.

The following actions are recommended regarding these hazards:

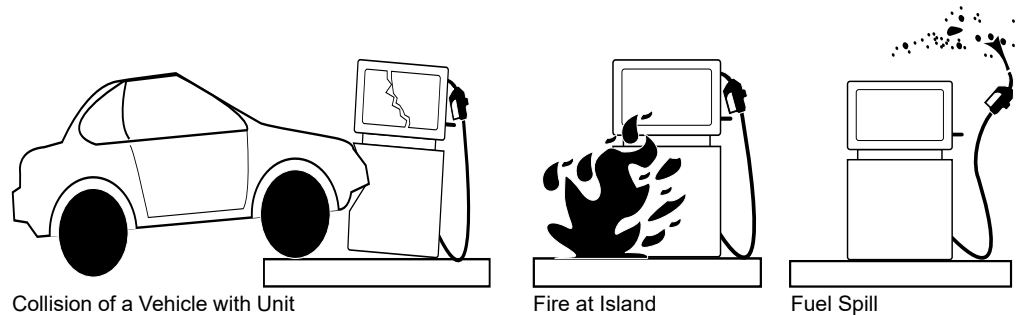

- Do not go near a fuel spill or allow anyone else in the area.
- Use station EMERGENCY CUTOFF immediately. Turn off all system circuit breakers to the island(s).
- Do not use console E-STOP, ALL STOP, and PUMP STOP to shut off power. These keys do not remove AC power and do not always stop product flow.
- Take precautions to avoid igniting fuel. Do not allow starting of vehicles in the area. Do not allow open flames, smoking or power tools in the area.
- Do not expose yourself to hazardous conditions such as fire, spilled fuel or exposed wiring.
- Call emergency numbers.

This page is intentionally left blank.

3 – Site Preparation

Station Layout



Gilbarco recommends that you follow the instructions given below:

- Consider traffic flow, kiosk, and store location when planning the location of pumps/dispensers.
- Plan islands for efficient routing of plumbing and wiring. Arrange product lines by hose and foundation layouts (refer to *MDE-3985 Encore Installation Manual*). Follow local codes.

Note: Efficient routing of plumbing and wiring potentially improves pump/dispenser flow rates and minimizes unit power requirements. Refer to “[Plumbing Requirements](#)” on page 5-1.

- Place pumps/dispensers so that customers can dispense fuel safely and conveniently.
- Install pumps/dispensers at least 8 feet apart on the island.
- Service technician must have easy access to the entire pump/dispenser (top, rear, front, and sides). Gilbarco recommends at least 60 inches of clearance from any structure (for example, wall or fence).
- Install protective posts at the ends of islands to protect pumps/dispensers against collision. Posts must not interfere with customer fueling.
- Ultra-Hi™ units with satellites may require a separate fence between the satellite and an adjacent truck lane. Consult local requirements and allow adequate clearance between the fence and unit for service access.

Americans with Disabilities Act (ADA) Requirements

IMPORTANT INFORMATION

To meet the reach requirements, as specified by the ADA, the dispenser island must not be higher than 6 inches tall.

Figure 3-1: ADA Requirements

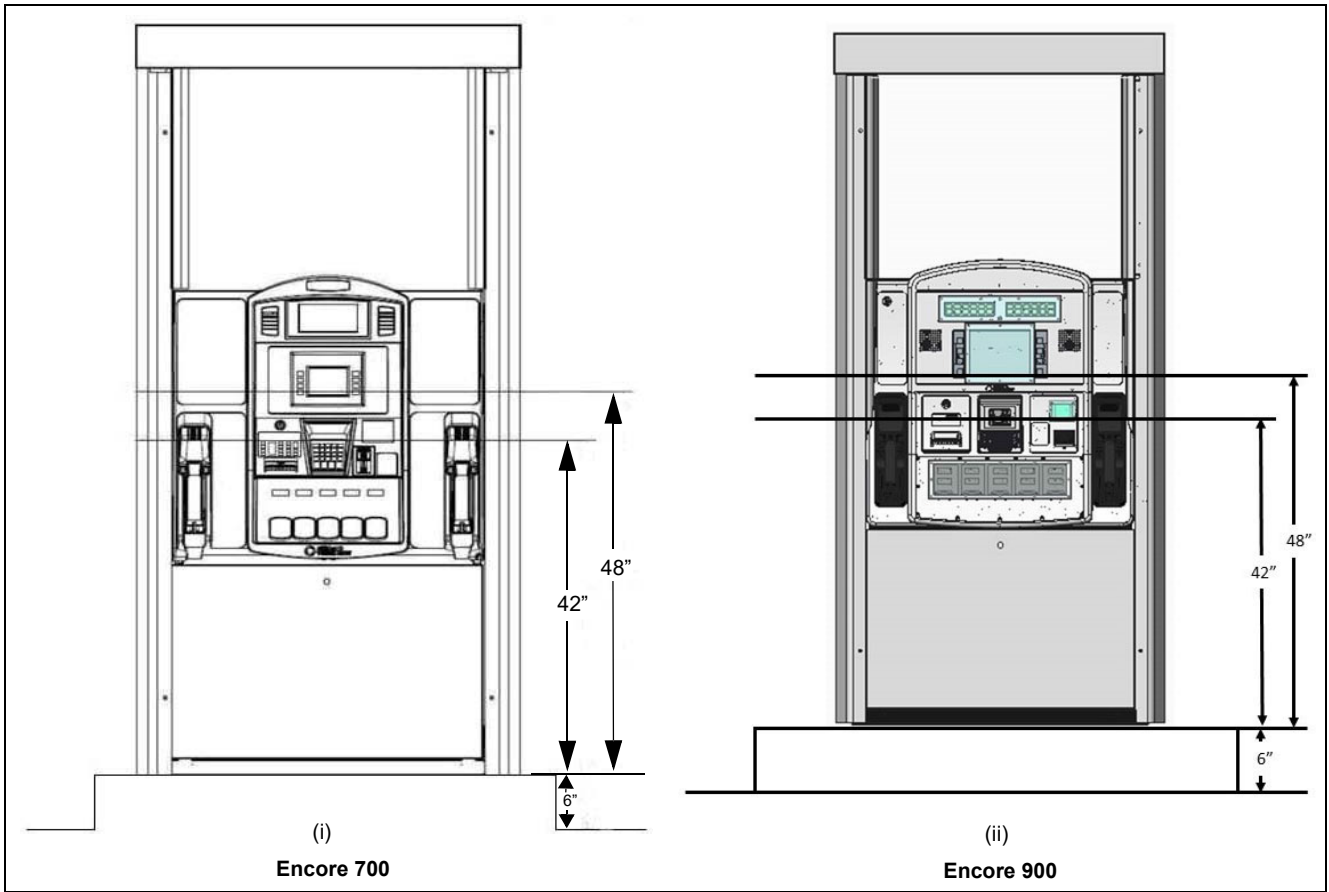

Station Security

It may be impossible with any manufacturer's unit, even if designed for security, to prevent theft. It is possible, however, to greatly reduce the probability that a theft is successful, if security measures are taken into consideration when designing the station layout and security-minded actions are planned into site operation. The following recommendations are intended to decrease the probability of theft by observance and/or incorporating obstacles that deter criminal activity.

Enhancing Security

Follow these guidelines for enhancing security:

- 1** Design stations where employees have a complete, unobstructed view of all fueling locations. Do not block employee views with merchandise displays or other obstructions. If complete view is not possible, utilize video surveillance equipment. Equipment monitoring must be made obvious and signs stating its use must be posted. Use surveillance cameras especially for areas of high risk or locations that are potentially blocked from your view.
- 2** Use pump/dispenser security kits when available.
- 3** Plan to use modular programming "time out" functions that shut down the unit if no pulser activity occurs for a preselected time.
- 4** Use the latest available version of the pump and dispenser software to avail the benefits of security enhancements. Consult your local ASC.
- 5** Plan to provide periodic/frequent inspection of equipment security provisions to verify their integrity.
- 6** Enter new programming access codes, as default codes are commonly known. These codes must only be known by trusted station employees and involved ASCs. Store the codes in a safe and secure location known to station management. Unit service may be more expensive if these codes are lost.
- 7** At installation, and all times thereafter, ensure that the lower door lock levers are adjusted correctly and not allowing the panels to be removed easily without a key or tools. If you suspect that keys are available to thieves in your area, consider using special locks or keys available from locksmiths.
- 8** Observe Point of Sale (POS) warnings or messages for units that are offline.

Equipment and Materials Required at Site

The following equipment and materials are required at the site:

- Special materials and components may be required for flexible fuels.
- Fuel storage tanks.
- STPs and leak detectors for dispensers.
- Piping and fittings.
- Pit boxes.
- Shear valves for dispensers.
- Shear valves or equivalent for pumps with above-ground tanks.
- Check valves for pumps.
- Conduit and gas/oil-resistant wiring.
- STP control relay boxes for dispensers.
- Dispenser Junction Box (J-box) kits for existing sites with the pump/dispenser replaced.
Note: No new wiring is to be pulled to the dispenser.
- Circuit breakers.
- Field wiring connection tool, manufactured by WAGO® (236-332).
- Isolation relays for electronic dispensers.
- Emergency power cutoff switch.
- Safety warning signs.
Note: Place warning signs (for example, No Smoking, Turn OFF Engine, and so on), where fuel customers will notice and read them. For warning signs, contact your local distributor.
- Conduit seal (potting) compound (as required by seal manufacturer).
- For DEF dispensers with overhead lines with no shear valves, use shut-off valves for each drop-down pipe and a manual or automatic air-bleed system at the high point of the line.
- For above-ground tanks with self-contained pumps, use vacuum actuated pressure regulating valve at the pump.
- Distribution box (D-Box) es.
- Thermostatically controlled heating strips and piping insulation for exposed DEF system plumbing.
- UL approved sealant suitable for the application/fuel involved.
- PAM™ 5000 for POS devices that do not communicate through Gilbarco two-wire to the dispensers.
- Ground Fault Interrupt (GFI) devices for units installed on skid tanks.

4 – Electrical Requirements

The electrical requirements are as follows:

- Prepare sites as per NFPA 30A, NFPA 70, and applicable national, state, and local codes/regulations.
- Use licensed electricians to make all electrical connections.
- Use a dedicated circuit/phase system. Wire all electronic units to the same power leg.
- Use an earth ground for circuits.
- Mount all circuit breaker panels and relay boxes securely to the wall.
- Use UL-recognized/approved components and/or systems.
- Recommended voltages for pumping units are 220 VAC single-phase or 380 VAC three-phase.
- Route product wiring to protect from damage, using conduit as required.

Note: Pumping units operate at higher load levels than dispensers. Refer to FE-363 Field Wiring Diagram Encore 500/700/900 (M07555 Power Supply Only) and FE-364 Field Wiring Diagram Encore 300.

In Canada, installing communication circuits, such as data cables and AC cables, in the same conduit as AC circuits is contrary to the Canadian Electrical Code (CEC) rule 60. New installations must have separate conduit for data/communication cables and power cables in the following circumstances (wiring for two-wire, data, communications, intercom, video, Ethernet, Gilbarco Long Range Ethernet (GLRE), must be in a separate conduit from the dispensers power and light conduit):

- All new installations of fuel dispensers or other electrical equipment, whether or not the raceways are exposed and made readily accessible as part of the installation process; or
- In any event if the raceways are exposed and made readily accessible for any reason.

Emergency Power Cutoff Switch

The following are requirements for installing and accessing the emergency power cutoff switch:

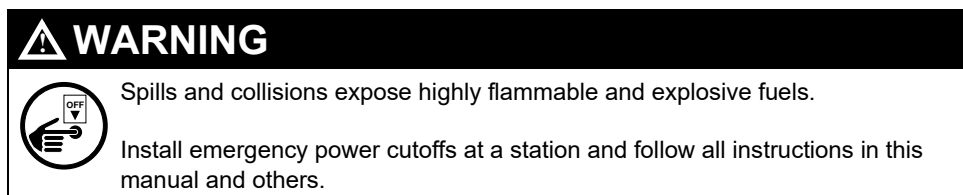

- NFPA 30A and Gilbarco require that you install one or more emergency power cutoff switches.
- An emergency power cutoff switch is a single control that removes AC power to all the island equipment (pumps/dispensers, STPs, canopies, lights, and so on). The emergency power cutoff switch must also remove power to the auxiliary devices that are attached to the dispenser, such as communication wiring, third-party add-on devices, intercoms, and so on.
- Ensure that the emergency power cutoff switch is accessible, label it clearly, and install it away from any hazards that may occur at the pumps/dispensers. Do not install cutoff switches more than 100 feet away from the pumps/dispensers.

- Familiarize all employees with the location of the emergency power cutoff switch and its usage. Ensure that you remind them at frequent intervals.

Note: Do not use E-STOP, ALL-STOP, or PUMP STOP keys on Gilbarco console/cash registers to shut-off the pump/dispenser power. These keys do not remove AC power and do not always stop product flow.

IMPORTANT INFORMATION

Devices, such as D-Boxes and PAM 5000, and two-wire must be de-energized or have wiring disconnected from the dispenser by the emergency stop or equivalent mechanism. Third-party devices, such as those supplying power to any form of communication to a dispenser (intercoms, external devices connected to the Applause Media System (Encore), third-party controllers and so on), must also be de-energized or the wiring supplying that power be disconnected. Provision to accommodate this must not introduce noise [Radio Frequency Identifier Device (RFID) or electrical] into sensitive pump dispenser electronic field wiring circuits during normal pump/dispenser operation. De-energizing of the external equipment through the emergency stop or equivalent device is recommended.

Circuit Breakers

Requirements for circuit breakers are as follows:

Figure 4-1: Using Circuit Breakers

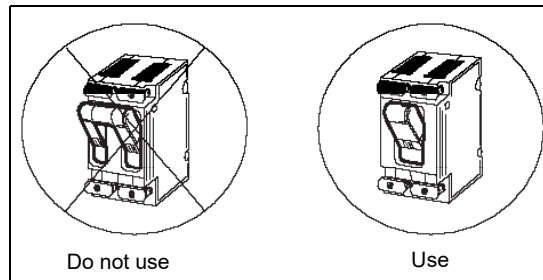

- Install a dedicated UL/CUL-listed switched-neutral breaker (except for Canada) to each circuit leading to a pump/dispenser or dispenser and STPs. It must be able to disconnect hot and neutral conductors simultaneously. Canada requires that only hot conductors be switched. Single-pole breakers with handle ties shall not be permitted. Refer to *National Electric Code NEC 514*.
- Use only a UL/CUL-listed circuit breaker panel, as appropriate for that area.
- Install circuit breakers away from the pumps/dispensers. They must be readily accessible and clearly marked with the pump/dispenser number involved.
- Install a separate circuit breaker for each STP (dispenser models) or each pump motor (self-contained models). Identify each circuit breaker to recognize the STP involved.
- Install one circuit breaker for each pump/dispenser or a small island group to allow powering down of pump/dispenser for service. Installing more than one pump/dispenser per circuit breaker causes potentially more than one dispenser to be down during service work. This can affect station operation significantly.
- Ensure that you consider any additional loading for auxiliary devices, such as DEF heaters when sizing circuit breakers.
- Use GFI breakers for units mounted on skid tanks.

STP Control Relay Boxes for Dispensers

Follow these instructions for STP control relay boxes:

- Install a separate control relay for each STP.
- Do not use the dispenser relay to power the STP.
- Combined STP control relay/isolation relay boxes are recommended.
- Label the box/relay to identify the STP involved.

STP Isolation Relays for Electronic Dispensers

STP isolation relays provide electrical isolation between dispensers, prevent damage from cross-phasing, and also protect service personnel during service activities. Refer to *MDE-2755 STP Control and Dispenser Isolation Relay Box (PA0287)* and *FE-321 Gilbarco STP Isolation Relay Box (PA0287)*.

Note: For three-phase STP, use isolation relay at the input of the three-phase STP control box.

- Gilbarco requires installation of STP isolation relays in addition to STP control relays.
- Use isolation relays for each STP control line at each dispenser or dispenser grouping on a single circuit breaker.
- Route neutral wire to the control relays from the dispenser circuit breaker [refer to *FE-321 Gilbarco STP Isolation Relay Box (PA0287)*].
- Combined STP control relay/isolation relay boxes are recommended.

Conduit

If not already required, Gilbarco recommends that a spare conduit be run for future high-speed communications. For details, refer to “[High-speed Communication Wiring](#)” on [page 4-6](#).

Instructions regarding the conduit specifications are given below:

- Use a 1-inch trade-size rigid aluminium conduit with Encore and Eclipse pumps/dispensers to connect wires to the pump/dispenser. Two-wire data wires can share the power-wiring conduit (refer to model-specific wiring diagrams). When retrofitting to an existing island that uses a 3/4-inch conduit, provisions must be made for transition to a 1-inch conduit to pass through the 1-inch air-gap plates when a unit does not have a factory-installed J-box. To maintain the integrity of the air gap, it is required that only 1-inch conduit pass through any air-gap conduit adapter plate 1-inch holes.
- Use different 1-inch conduits for intercom and other class two-wiring. When retrofitting to an existing island that uses a 3/4-inch conduit, provisions must be made for transition to a 1-inch conduit to pass through the 1-inch air-gap plates. To maintain the integrity of the air gap, it is required that only 1-inch conduit pass through any air-gap conduit adapter plate 1-inch holes.
- Use threaded, rigid metal conduit or a rigid non-metallic conduit for applications below the pump/dispenser to carry electrical wires. Conduit must conform to national and local electrical codes. If you use non-metallic conduit, it must be at least 2 feet underground. The last 2 feet of the underground run to the ground interface must be a rigid metal conduit or threaded steel intermediate metal conduit. Tighten all threaded conduits.
- Never share dispenser power or two-wire communication conduit with other manufacturer’s equipment (for example, speaker wires, canopy lights).

Note: You can use the same conduit for routing power to the pump/dispenser and the two-wire data loop. The two-wire data loop is a Class 1 circuit.



- Never rely on metal conduit to provide an equipment ground. Run a separate ground wire. Separate and isolate pump/dispenser wiring from other equipment wiring in wiring troughs.
- Never use knock-out boxes or flexible conduit for installation.
Note: Extra J-box added to the pump/dispenser must be listed Class 1, Div. 1, Group C and D explosion-proof.
- Use electrical fittings that are listed for Class 1, Group C and D hazardous locations, as required by NFPA 30A and NFPA 70.
- A seal-off 'Y' fitting (for example, Killark® Type EY) must be installed on all units as a first connection where conduit leaves the ground.

Wiring



For high-speed communications information, proceed to “[High-speed Communication Wiring](#)” on page 4-6.

- Wire all pumps/dispensers as per NFPA 30A, NFPA 70 and applicable national, state, and local codes/regulations.
- Wire all circuits as NEC Class 1 except the speaker (intercom) circuit which must be NEC Class 2. Install the speaker (intercom) circuit in a separate 1-inch conduit.
- Use stranded gas and oil resistant copper wire rated for 300 V (up to 240 VAC source) and 176 °F (80 °C). Do not use solid wire.
- In the main conduit, for two-wire communications, use only twisted-pair wiring as per the diagram. Do not use shielded twisted-pair wiring.
- Unshielded twisted pair wire is required for two-wire communication wiring for new stations. Previously wired stations may continue to use existing non-twisted pair wiring, which has passed short and continuity testing, but is more susceptible to noise and lightning damage.
- Leave 6 to 8 feet of wire out of conduit for connection to dispenser.
- Dispensers and POS must share the same phase. Phasing and grounding should be verified prior to start-up and meet all local codes and regulations.
- Wire dispensers, POS, D-Boxes, etc., on a single phase in a dedicated electrical panel (recommended) and have other potentially noise sources, such as compressors, motors, and so on, in a different electrical panel. Ensure proper care to minimize noise sources present on the phase that is used for dispensers and related equipment. If multiple phases are required, use industry best practices to keep noise generating circuits as isolated as possible from the fueling component circuits.
- All equipment that is connected using communication connections, dispenser communications, and related power outlets and power sources for PIN pads, gas price signs, scanners and so on must always be kept **on the same phase of power as the dispenser power**.
*Notes: 1) Communication connections such as CAT5/6, RS-485, and RS-232.
2) Dispenser communications such as Gilbarco two-wire to the fueling system including POS/Back Office System/Fuel Monitoring System/Network Communication/Dispenser Communication and Control System (Applause Media System or high speed data)/Other Payment, Loyalty Systems, and Car Wash Controllers.*
- Use listed wire nuts for all connections. Do not use tape.
- Pull spare wires for future use.
- Protect conduit ends and wire from water ingress or thread damage after installation, before installation of the pumps/dispensers.
- Seal-off 'Y' fitting(s) must be potted after all wires are run to termination points.

In Canada, installing communication circuits, such as data cables and AC cables, in the same conduit as AC circuits is contrary to the CEC rule 60. New installations must have separate conduit for data/communication cables and power cables in the following circumstances (Wiring for two-wire, data, communications, intercom, video, Ethernet, GLRE, must be in a separate conduit from the dispensers power and light conduit.):

- All new installations of fuel dispensers or other electrical equipment, whether or not the raceways are exposed and made readily accessible as part of the installation process; or
- In any event if the raceways are exposed and made readily accessible for any reason.

For additional wiring notes and requirements, refer to the following documents:

- *FE-341 Field Wiring Diagram The Eclipse Series Dispensers.*
- *FE-363 Field Wiring Diagram Encore 500/700/900 (M07555 Power Supply Only).*
- *FE-364 Field Wiring Diagram Encore 300.*

Data Wire Lengths

Use the following table to determine maximum data wire lengths:

CAUTION

Failure to follow the requirements in the table below could result in communication issues between the pumps/dispensers and POS that are not covered by warranty.

D-Box	Distance Between D-Box and Dispenser (Maximum)	Distance Between D-Box and Console/Controller (Maximum)
PA0133, PA0187 G-SITE®	Total data wire system run no more than 2600 feet with 14 AWG	
PA0242 Transac® System 1000	2600 feet with 14 AWG	2600 feet with 14 AWG
PA0261 Universal D-Box	2600 feet with 14 AWG	2600 feet with 14 AWG
PA0306 D-Box	2600 feet with 14 AWG	2600 feet with 14 AWG
PA0409	1000 feet with 14 AWG	2600 feet with 14 AWG

Note: When installing new two-wire communication wiring, use unshielded twisted-pair data wires. Shielded wire must not be used. Wiring and insulation specifications are as follows:

- **Wiring specification:** *Two-wire twisted-pair [Unshielded Twisted-Pair (UTP)] with 10 to 12 twists per foot, stranded annealed copper tinned with 18 AWG minimum required for runs up to 1000 feet or 14 AWG minimum for runs up to 2600 feet. Do not daisy-chain communications wiring.*
- **Insulation specification:** *Polyvinyl Chloride (PVC) insulation of type Thermoplastic Flexible Fixture Wire Nylon Jacketed (TFFN) or Machine Tool Wire (MTW), UL-approved gasoline, and oil-resistant. Refer C&M Corporation part number 27525 (18 AWG) or equivalent. The Gilbarco part number for the wire is Q13221-2.*

High-speed Communication Wiring

Figure 4-2 shows the twisted-pair wiring for Encore and Eclipse series.

Figure 4-2: Encore and Eclipse Series Twisted-pair Wiring (Typical)

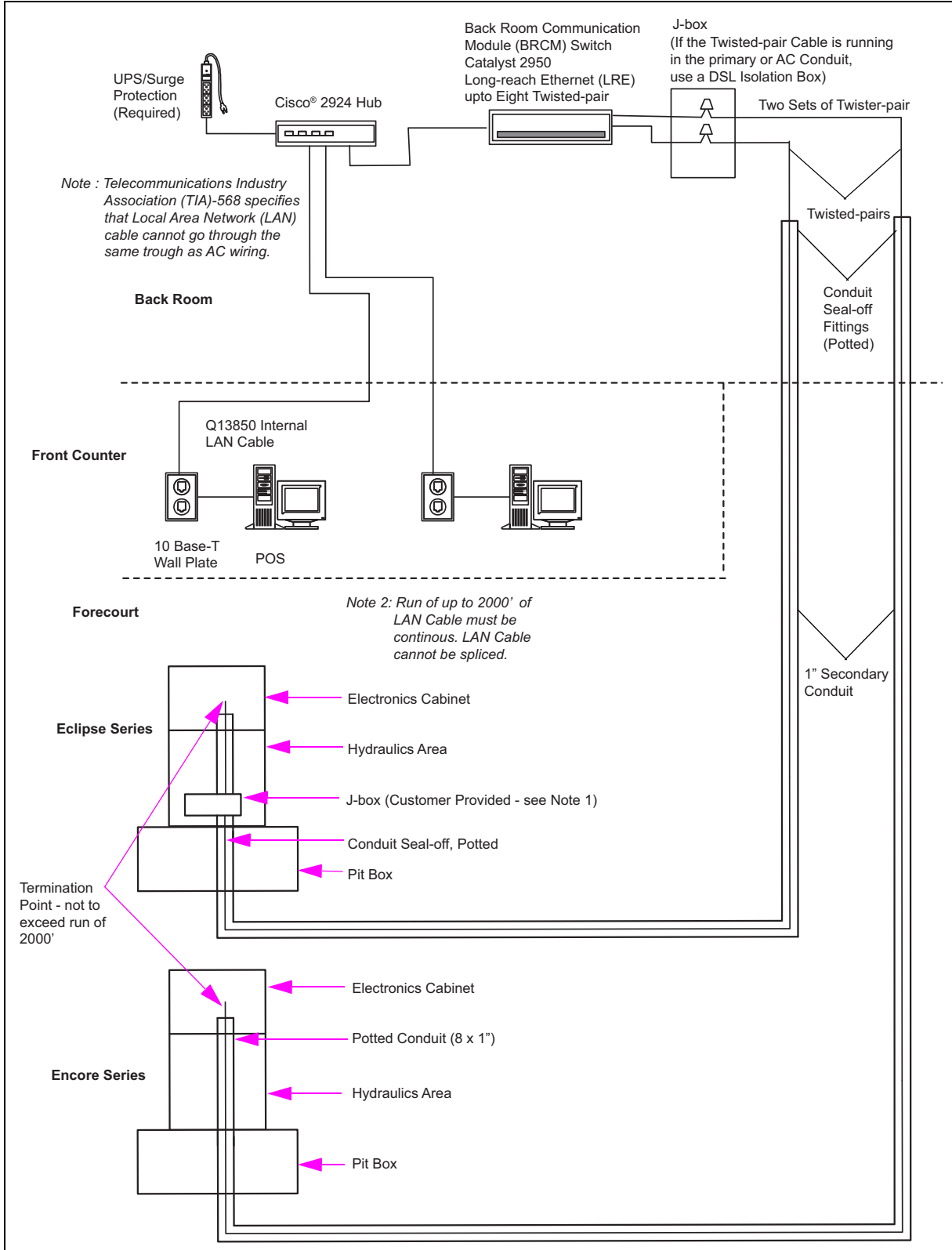

Auxiliary Conduit

Gilbarco recommends the use of 1-inch rigid metallic conduit and fittings (refer to “Conduit” on page 4-3) for the auxiliary conduit used for wiring, apart from the dispenser power or two-wire communications. This will allow up to two speakers and two call/stop buttons per side, and high-speed communications.

Ethernet Cable



Gilbarco requires use of 10 Base-T Cable or CAT5 Cable as specified in this manual for high-speed communication wiring. Gilbarco specified cables must be used to permit issuance of a CoC and/or warranty. Use of other cable types may also create a hazardous situation or result in equipment malfunction.

WARNING



Petroleum vapors may migrate inside the cable insulation between conductors and sheathing of various cables, including 10 Base-T or CAT5E Cable. Vapors may ignite, leading to serious injury or death.



It is crucial that the installer follow NECs, Article 501 requirements by removing the outer jacket and spreading the wire pairs at the seal-off points of the CAT5E Cable, so that a good vapor seal is achieved. This is required because all CAT5E Cables will conduct vapors inside their outer jacket.

Use only 10 Base-T wiring specified by Gilbarco. Failure to follow this may result in bad or intermittent communication to the POS device.

The cable has the following properties:

- Safety Certification: UL Listing AWM Style 21094 176 °F (80 °C) 300 V.
- Vapor Test: Compliant to UL Standard 87, Section 36A, Para. 22.17

Ethernet Cable Installation Personnel and Procedures

IMPORTANT INFORMATION

A copy of the “ANSI/TIA/EIA TSB-67 Certification of Conformance” from the wiring personnel must be provided to the ASC before the site can be commissioned. The certificate is part of the documentation that must be on file at the installation site. A certification of the field test will be required at equipment start-up. Contact Gilbarco with any questions regarding this procedure.

Ethernet cable must be installed by certified telecommunications technicians in accordance with “ANSI/TIA/EIA 568-A Commercial Building Telecommunication Cabling Standards (and Amendments)”.

The following table lists the documents that must be read and understood by the technician who installs:

Document	Title
ANSI/ Institute of Electrical and Electronics Engineers (IEEE) 142-1991	Recommended Practice for Grounding of Industrial and Commercial Power Systems (IEEE Green Book)
ANSI/IEEE 1100	Recommended Practice for Powering and Grounding Sensitive Electronic Equipment (IEEE Emerald Book)
ANSI/TIA/EIATSB67	Transmission Performance Specification for Field Testing of UTP Cabling Systems
ANSI/TIA/EIA568-B	Commercial Building Telecommunication Cabling Standards (with Amendments)

Grounding

The following are the requirements for grounding:



- NFPA 70 requires that you connect the following to system ground:
 - Consoles
 - Pumps and dispensers
 - STPs
 - Relay control boxes
 - Circuit breaker panel
 - Electronic leak detectors
- Gilbarco requires that you connect each pump/dispenser to an equipment grounding conductor located in the conduit as per NFPA 70, Article 250.

The following applies to ground conductor:

 - Gilbarco recommends using wire no smaller than 12 AWG. A larger wire may be required as per NFPA 70, Article 250.
 - Use wire with green or green and yellow striped insulation.
 - Connect to green grounding screw in the J-box or designated connection in the electrical cabinet for units without J-boxes.
 - Provide the proper ground as provided for under NFPA 70, Article 250.
 - Bond the neutral bus to an approved grounding electrode.

Figure 4-3: Grounding Plan (Typical)

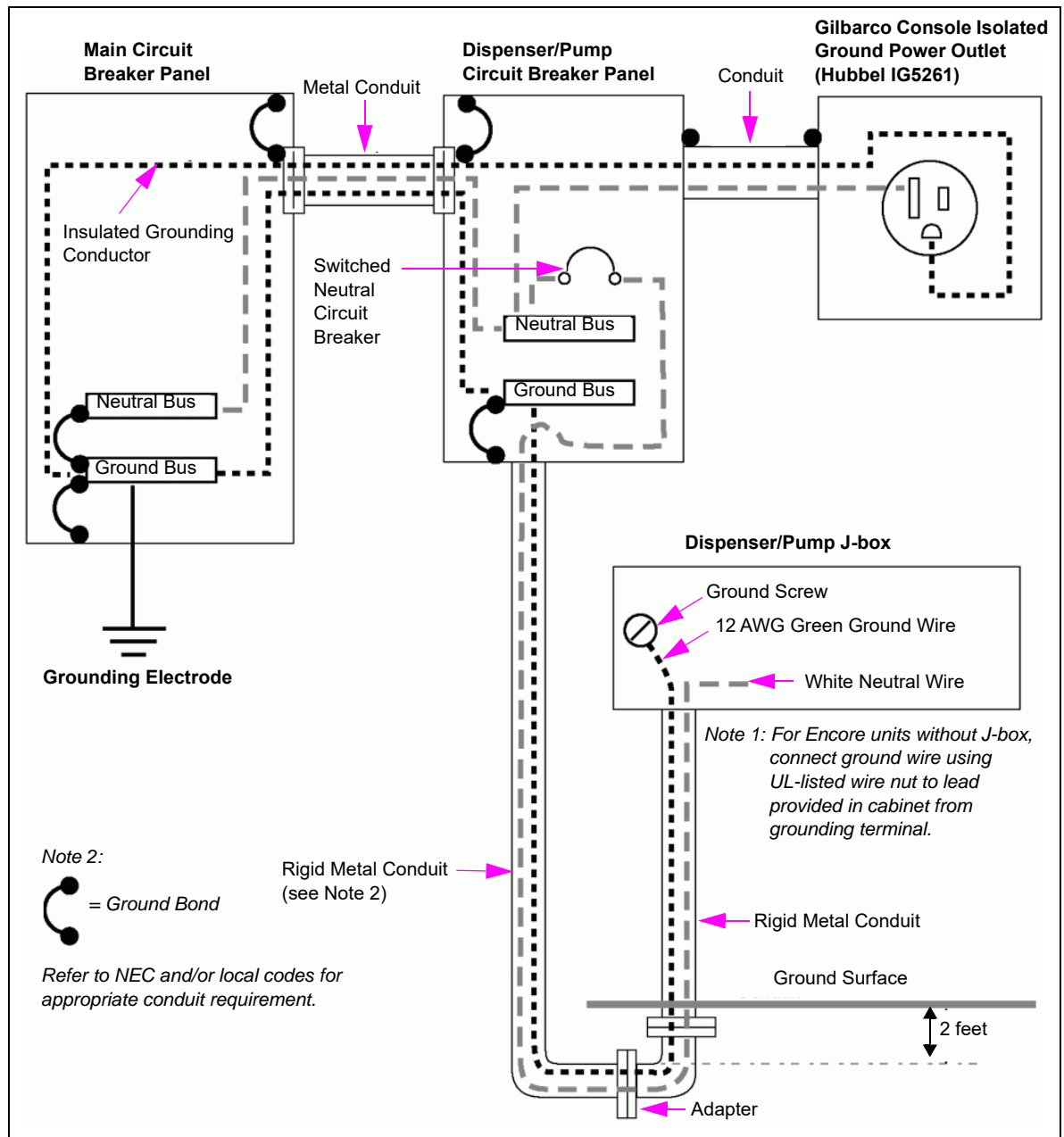

Sealing 'Y' Fittings

'Y' seals are installed in the conduit runs to minimize passage of vapors, gases, or flames from one portion of the electrical installation to another through the conduit. Fittings must be installed in accordance with Articles 501-5 and 502-5 of the NEC and fitting manufacturer's instructions.

IMPORTANT INFORMATION

Wiring must be tested for proper continuity and verification. No shorts must exist between individual wires or any wire to metallic before potting any Y fittings.



Gilbarco uses Killark type EY fittings and recommends them or their equivalent for vertical conduit runs.

Note: The following sealing directions are for Killark fittings only, and instructions may vary for other manufacturer's fittings. Read all instructions completely before you begin.

Figure 4-4: Sealing Killark Fittings

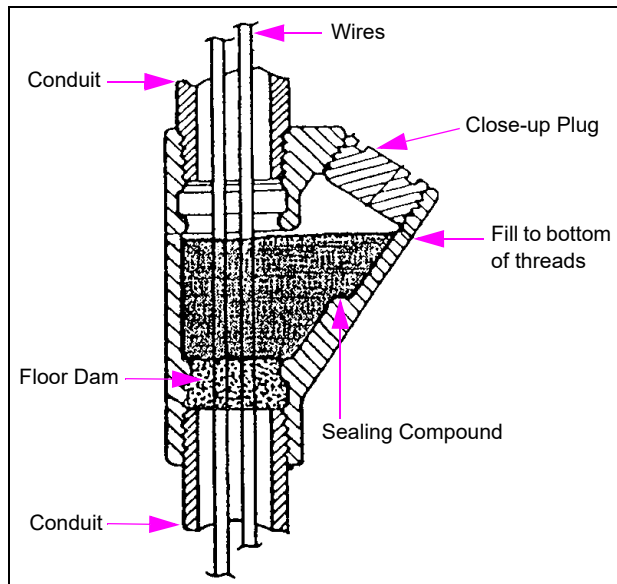

To seal Killark fittings, proceed as follows:

- 1 Remove the close-up plug.
- 2 Separate conductors and fill the conduit in and around conductors using Killark type "PF" packing fiber to a floor dam to ensure that the fluid sealing compound is held.

Note: Floor dam must be even with the conduit stop in the lower hub of fitting. Ensure that you prevent damage to the conductor insulation. Force the packing between conductors and hubs, pushing any shreds of packing fiber away from conductors to prevent leakage path.
- 3 Use only Killark type "SC" sealing compound with Killark fittings, and do the following:
 - Use a clean mixing vessel for every batch of sealant.
 - Mix the compound at the rate of three parts compound to one part water by volume.
 - Sprinkle the compound in water while stirring, until a thick paste is formed.

Note: Do not mix more compound than can be used in 15 minutes.
 - Continue mixing for at least 3 minutes, until consistency is just fluid enough to pour slowly, like thick gravy (not watery).
- 4 Slowly pour approved fluid compound into the sealing fitting to the level of the bottom of threads for close-up plug.

Note: Ensure that you pour slowly to avoid trapping air bubbles in seal.
- 5 Immediately wipe off any spilled compound and close the seal with close-up plug.

Note: Initial setting of sealing compound will occur within 30 minutes. Compound requires a minimum of eight hours above 32 °F (0 °C) to develop sufficient strength to withstand explosion pressures.

5 – Plumbing Requirements

Fuel Tanks

Follow tank manufacturer's instructions, national, state, and local regulations for storage tank installation.

Note: Fiber glass tanks manufactured earlier than 1992 may not be compatible with certain alternative fuels, such as E85.

On pumps (self-contained units), it is recommended that a vertical lift of 10 feet must not be exceeded. The Environmental Protection Agency (EPA) and Application Programming Interface (API) regulates the vapor pressure of gasoline. A lift greater than 10 feet may result in pumping unit noise and/or low flow rates.

Notes: 1) The maximum lift is defined as the vertical distance from the bottom of the suction pipe in the storage tank to the pump shaft center line of the pumping device.

2) Install a Gilbarco Model 52 or equivalent vacuum-actuated valve (per NFPA 30) directly beneath a self-contained pump when above-ground storage tanks are used. Without a vacuum-actuated valve, sump may overflow. For more information, refer to the manufacturer's installation instructions, Gilbarco Product Service Bulletin 26-91, and "Check Valves (Used on Pumps and Ultra-Hi Units Only)" on page 5-5.

⚠ WARNING



Highly flammable and explosive fuels are present.



Failure to observe all safety precautions could result in severe injury or death. Observe all safety precautions in this manual and others.

⚠ WARNING

DEF, flexible fuels, such as biodiesel; high alcohol percentage fuels, such as E85, may be incompatible with certain plumbing materials and hydraulic components.

Use of incompatible materials or components with alternative fuels, such as E85, or alternative fluids can result in leaks or unexpected failures of components, resulting in fire, explosion, or environmental damage.

When dispensing alternative fuels, such as E85, or alternative fluids verify with the manufacturer if the material of all plumbing components are compatible with the fuels or fluids being dispensed.

Fluid Handling Components for DEF

Stainless steel 304 or 316, certain plastics like High Density Polyethylene (HDPE), and certain elastomers are the only acceptable materials for parts that store or come in contact with DEF. Verify with the manufacturers if materials of their plumbing components are compatible with mildly corrosive DEF for the environmental and operational conditions experienced by DEF dispensers.

DEF freezes at 12 °F (-11 °C). Precautions must be taken to prevent freezing of the fluid if the environment where the dispenser is installed is likely to induce freezing. Precautions include insulation and heat tracing. All installed components must comply with UL Class 1 Division 2 requirements. If insulation is used, exercise care to prevent any gaps in coverage as freezing and damage could occur.

If DEF lines are installed above ground and/or in the fuel station canopy, effective means of air elimination must be applied to prevent accuracy issues. Accuracy issues arise due to the air entrained in the fluid flow.

If DEF lines are installed above ground and/or in the fuel station canopy, exercise care to prevent solar loading from heating the fluid in pipes. This condition can also present accuracy issues.

Shut-off valves must be provided on the inlet line upstream of each dispenser, to allow for individual servicing.

Recommended Hose Material for DEF

The hose material used with DEF units must conform to the following:

- Material must be compatible with the DEF being dispensed (32.5% urea solution).
- Material must be compatible with the environmental conditions being experienced by the hose plumbing.
- Material must withstand the maximum operating pressure, including the hydraulic shock that may be experienced during operation.

Skid Mounted Tanks for DEF Dispensers

Ensure that you read, understand, and follow any manufacturer-supplied installation documents for skid mounted tanks for DEF dispensers.

Leak Detectors

Use only listed leak detectors. Follow the manufacturer's instructions for leak detector installation.

Note: Components must be compatible with the fluid type being dispensed. For more information, contact the respective manufacturer.

STPs

Use only listed STPs. Follow manufacturer's instructions for the installation of STPs.

Notes: 1) Components must be compatible with the fluid type being dispensed. For more information, consult the concerned manufacturer.

2) Air separation provisions must exist within the STPs to ensure that calibration is accurate and no calibration issues occur.

Important Considerations for Sizing STPs

When dispensing gasoline/ethanol blender, cross contamination between the two tanks must be avoided. Do not oversize one STP over the other as the line pressure of the stronger STP could overpower the weaker STP.

Pipe Installation

Figure 5-1 shows the product inlet and vapor pipes for Gilbarco pumps/dispensers.

Figure 5-1: Marking Fuel Grade Names

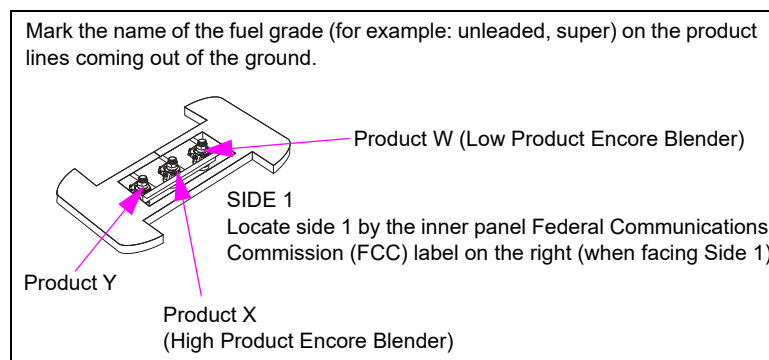

Refer to Petroleum Equipment Institute (PEI) publication “RP100 Recommended Practices for Installation of Underground Liquid Storage Systems (Chapter 9)” and PEI publication “RP200 Recommended Practices for Installation of Above-ground Storage Systems for Motor Vehicle Fueling”.

Product inlet pipes and vapor pipes for Gilbarco pumps/dispensers vary in location between models. Product piping order differs from blenders to previous Advantage models.

See model-specific footprint before installing pipes.

- Check national, state, and local regulations for installation of pipe system.
- Use containment system as required by national, state, and local regulations.
- Below the unit, use UL and code-approved flexible pipe (constructed of UL-approved pipe material and UL-approved fittings).

Note: Some regulatory agencies do not allow the use of a galvanized piping component when diesel is involved. Consult local regulators. Also, galvanized piping is not usable for certain alternative fuels, such as E85, or biodiesel.

- Alternative fuels, such as E85, or fluids, such as DEF, may require special piping materials or components. Consult the manufacturer to determine whether the piping material is compatible with the fluid being used. Use 2-inch risers on Ultra-Hi units that use a 2-inch shear valve.
- Leak detectors may not detect leaks reliably in plumbing between master and satellite Ultra-Hi units. Secondary containment and likely specialized leak-detection equipment is required. Consult codes.

Acceptable Pipe Material for DEF

Stainless Steel Grade SS 304 or 316 is the only acceptable metal pipe material for DEF. HDPE pipe can also be used with DEF.

Certain elastomeric hoses are acceptable for use with DEF units. For recommendations for safe use under the operational, pressure, and environmental conditions that will be experienced by the hose, consult the hose manufacturer.

Pipe Size

The required pipe size depends on the number of units sharing lines, size of the STPs (dispensers only), and length of the run. Follow the guidelines below:

Pumps (Standard Flow)

Use new pipes of 2, 2-1/2, or 3 inches.

- Pipe of 2 inches for runs up to 50 feet to a single pump.
- Pipe of 2-1/2 or 3 inches for longer runs up to 75 feet to a single pump with maximum lift condition.

Note: A dedicated line is recommended to supply each self-contained pump.

Pumps (High Flow)

Use new pipes of 3, 3-1/2, or 4 inches.

- Pipe of 3 inches for runs up to 50 feet to a single pump.
- Pipe of 3-1/2 or 4 inches for longer runs up to 75 feet to a single pump with maximum lift condition.

Note: A dedicated line is recommended to supply each self-contained pump.

Dispensers (Standard Flow)

Use new pipes of 2, 2-1/2, or 3 inches.

- Notes:*
- 1) *If the distance from the STP to the farthest dispenser is 200 feet or less, use a pipe of 2 inches.*
 - 2) *If the distance exceeds 200 feet, use a pipe of 2-1/2 or 3 inches to the first dispenser and a pipe of 2 inches along the rest of the way. Trunk lines supplying multiple dispensers must be larger and must be sized to provide low pressure drops for an anticipated flow rate. Use of smaller size pipes may result in lower flow rates than normally accepted.*

Dispensers (High Flow)

Use new pipes of 3, 3-1/2, or 4 inches.

- Notes:*
- 1) *If the distance from the STP to the farthest dispenser is 200 feet or less, use a pipe of 3 inches.*
 - 2) *If the distance exceeds 200 feet, use a pipe of 3-1/2 or 4 inches to the first dispenser and a pipe of 3 inches along the rest of the way. Trunk lines supplying multiple dispensers must be larger and must be sized to provide low pressure drops for an anticipated flow rate.*

Dispensers (Ultra-Hi High Gallon)

Use new pipes of 3 or 4 inches.

- Notes:*
- 1) If the distance from the STP to the farthest dispenser is 75 feet or less, use a pipe of 3 inches.
 - 2) If the distance exceeds 75 feet, use a pipe of 4 inches to the first dispenser and a pipe of 3 inches along the rest of the way. Trunk lines supplying multiple dispensers must be larger and must be sized to provide low pressure drops for an anticipated flow rate.

Special Notes for Systems Experiencing Fuel Conversions

Certain installations may involve converting fuels in existing tanks to other types of fuels. Generally, the types of conversions listed below can create issues with dispensing and other equipment where the new fuel cleans the tank, causing excessive filter changes after installation and potential equipment damage. Dispensing filters are not intended to provide absolute filtration, so very highly contaminated fuels can seriously affect the unit performance and life of the hydraulic components. Pumping excessive contamination through pumps/dispensers is considered abuse and can void warranty on certain hydraulic components.

Exercise extra caution during the following situations:

- Conversion of straight gasoline to gasoline with alcohol content (or even gasoline with low alcohol to gasoline with high alcohol)
- Conversion of gasoline or diesel to pure alcohol
- Conversion of diesel to gasoline
- Conversion of gasoline or diesel fuels to fuels with a more aggressive additive package
- Conversion of standard diesel to Ultra Low Sulfur Diesel (ULSD)
- Conversion of diesel to biodiesel

If such conversions are part of the installation, site tanks and plumbing require thorough cleaning using industry accepted tank cleaning practices, before dispensing fuel through the new pumps or dispensers.

Check Valves (Used on Pumps and Ultra-Hi Units Only)

For information on installing the check valves for pumps, refer to PEI publication “RP100” and manufacturer’s installation instructions. Install the check valve as close as practically possible to the suction unit. It must be gravity-activated with minimal, or no spring load. Check valves for use internal to the pumping unit are available from Gilbarco as an order entry item.

Ensure that there is only one check valve in each dedicated line (preferred method). Use of multiple check valves can restrict flow and cause cavitation, resulting in significant flow rate reductions. If installation necessitates placing more than one unit on a single dedicated product line, then check valves must be placed at each pumping unit. Check valves must be accessible for service.

The inlet check valve for Ultra-Hi units is required for accuracy in metering fuel. Use a factory-installed option or installation-installed check valve of low pressure drop.

Note: Components must be compatible with the fluid type being dispensed. For more information, contact the respective manufacturer.

Shear Valves (Generally Used on Dispensers Only)

⚠ WARNING	
	<p>Dispensers that are knocked off from the island can expel fuel. Explosion and fire could result in severe injury or death.</p> <p>Installation of shear valve is required by NFPA 30A. Install the shear valve accurately per manufacturer's instructions.</p>

- Notes:*
- 1) Shear valves are not typically required on pumps but installation is discretionary and sometimes required. Consult local codes.
 - 2) Components must be compatible with the fluid type being dispensed. For more information, consult the concerned manufacturer.

Refer to PEI publication “RP100 Recommended Practices for Installation of Underground Liquid Storage Systems (Chapter 9)” and PEI publication “RP200 Recommended Practices for Installation of Above-ground Storage Systems for Motor Vehicle Fueling”. A shear valve is a NFPA 30A required safety device. It closes automatically to stop product flow during a fire or if the dispenser gets knocked off the island. It also provides a means of manually closing inlet pipes.

Note: Shear valves are recommended and sometimes required for vapor recovery lines. For more information, consult local or state regulatory agencies.

Figure 5-2: Installing Shear Valve

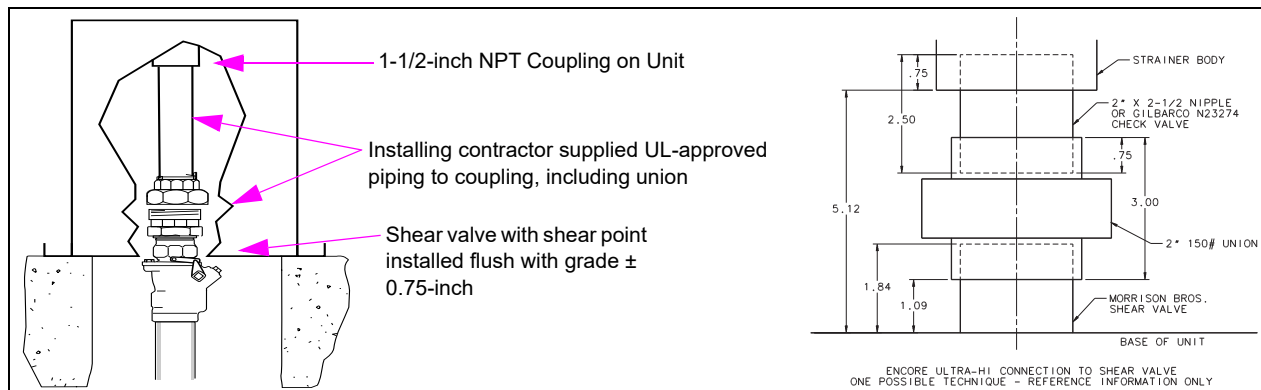

Follow shear valve manufacturer's instructions for installation procedures, testing, and so on.

- Install the shear valve on each product inlet pipe.

- Notes:*
- 1) Standard Encore and Eclipse dispensers require male top shear valves of 1-1/2 inch. Gilbarco strongly recommends using double poppet shear valves that shut-off flow from storage tanks and drain from the unit (for example, OPW® #10BHMP or Exxon® - OPW # 10RMSP).
 - 2) Encore Ultra-Hi - It is a mandatory code requirement that the shear section of the shear valve be within $\pm 3/4$ inch (or to shear valve manufacturer's requirement, whichever is tighter) from the plane of the bottom of the base of a dispenser. Not all shear valve styles will allow maintenance of this tolerance for Encore Ultra-Hi units. A Single Poppet Male Top (N23047) Morrison 2X2 636M-0200AV or code-approved equivalent shear valve meets code requirements. Do not modify dispenser plumbing (for example, remove strainer housing) to accommodate other model valves or installation units such that the shear groove of the shear valve is not within $\pm 3/4$ inch of the base plane of the dispenser. Use of a Check Valve (N23274) between the union and strainer housing will also ensure that the shear section is properly located.

Ultra-Hi dispensers require male shear valves of 2 inches.

Note: Use of shear valves lesser than 2 inches for Ultra-Hi units may result in equipment problems.

An Ultra-Hi check valve is required to ensure accurate metering of fuel (for example, Morrison Bros. 2 inch 636M).

- Install a shear valve on the master dispenser satellite outlet and at the satellite inlet.
- Do not mount the shear valve upside down.
- Ensure that the valve linkage is accessible and has no interference to opening or closing from other piping, structure or components.
- Do not anchor shear valves at this time. For anchoring procedures, refer to *MDE-3985 Encore Installation Manual*.

Note: The dispenser product inlet pipes must be aligned with the shear valve. Do not restrict shear valve linkage with pipes, and braces.

- Test shear valve operation.
- Close shear valve until equipment start-up. Cap the outlet pipe. This prevents dirt and other particles from getting in the dispenser product line. It also prevents fuel spillage.
- Connect the vapor return line. This can be performed in the following two ways:
 - Install a flexible connector or shear section on vapor return pipes as required by NFPA 30A to ensure that the product side shear valves will operate correctly. Use a 1-inch pipe of to connect vapor return pipes located inside the pump/dispenser.
 - ~OR~
 - Install a 1-inch shear valve listed for use with vapor recovery lines. Refer to *MDE-3187 K94227-XX, K94229-XX and K96576-01 Shear Valve Mounting Kit for Vapor Recovery Lines Installation Instructions*.

Figure 5-3: Male Top Shear Valve

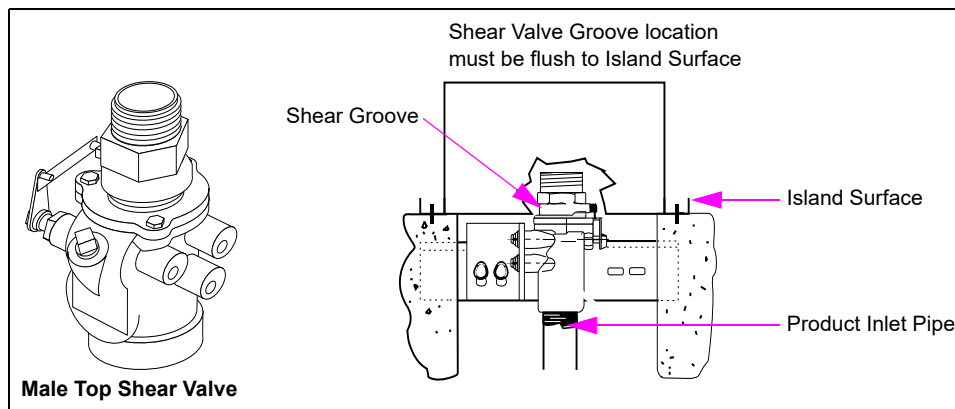

Encore Ultra-Hi Shear Valve Installation Notes

CAUTION

- Ultra-Hi units require a strainer before the meter.
- Unfiltered fuel passing through the Ultra-Hi can affect the operation or life of the meter, valve, and nozzle. Premature failure of these components because of lack of filtration is not covered by warranty.
- Never remove the strainer to install a shear valve. Use a shear valve that fits and allows use of the strainer.

The following considerations are critical to the success of installing the Encore Ultra-Hi shear valve:

- Selection of proper components mounted to the bottom of the strainer housing is critical in maintaining the proper location of the shear valve groove of the shear valve to the base plane of the dispenser. You must follow the shear valve manufacturer's required positioning for this groove.
- A check valve is required to insure accurate metering of fuel. Gilbarco recommends using N23274, which is about 2-1/2 inches long and can take the place of the close nipple located above the union.
- A union is required above the shear valve.
- A Morrison Male End Shear Valve [N23047 (Morrison # 636M-0200AV)] can be used to properly maintain the position of the shear groove. The installer must verify if other manufacturer's shear valves ensure proper positioning of the shear groove as per specifications.
- Double poppet shear valves will not fit the Ultra-Hi and may cause performance problems.
- Other combinations of unions, check valves, and shear valves may be possible and still maintain proper location of the shear groove.
- Removal of a strainer from the system will void warranty.
- Shear valves of 1-1/2 inches will restrict flow noticeably. Double poppet shear valves of 1-1/2 inches can create unit performance problems not covered by warranty.

Mounting Pit Box

Follow these guidelines for mounting a pit box:

- Use strongly designed pit boxes that will not twist, bend, or dislocate the shear valve during a collision.
- Use a pit box that will allow proper access to components during service, does not expose the pit after unit mounting, and properly fastens and supports the unit.
- Anchor pit boxes as per pit box manufacturer's recommendations. Use recommended fasteners and tighten according to manufacturer's instructions.
- Ensure that the pit boxes are compatible with alternative fuels, such as E85, or fluids, such as DEF, if used. Consult the pit box manufacturer.

Safety Signs

The following are some guidelines on safety signs:

- Safety signs warning of potential hazards may be required, depending on state and local codes, and NFPA regulations.
- Gilbarco requires installing applicable signs in locations likely to be noticed and read by the users of the equipment.
- Signs must be easily read, bilingual, durable, and fade-resistant. Unless local regulations dictate otherwise, nationally recognized safety symbols with brief text are recommended.
- Signs must include, but are not limited to the following:
 - Use approved containers
 - Turn vehicles off during fueling
 - Static electricity hazards during fueling
 - Health related warnings (involving fuels), advisement of fuel flammability/explosiveness, and others, as required
 - No smoking/match warnings
 - Emergency procedures

This page is intentionally left blank.

Index

A

Above-ground Storage Systems 5-6
 AC power 4-2
 ADA 3-2
 air-gap 4-3
 ALL-STOP 4-2
 aluminium 4-3
 Anchor 5-8
 Applause 4-2
 Article 250 4-8
 Article 501 4-7
 Article 501-5 4-9
 Article 502-5 4-9
 ASC 1-1, 3-3
 Auxiliary 4-7
 AWG 4-5, 4-8
 AWM 4-7

B

Base-T 4-7
 Bilingual 5-9
 Biodiesel 1-5, 5-1
 BRCM 1-3

C

canopies 4-1
 CAT5 4-7
 Check Valve 3-4
 check valve 5-8
 Circuit breaker 3-4
 Circuit breaker panel 4-8
 Class 1 4-4
 clearance 3-1
 code 3-1
 Collision 3-1
 conduit, electrical 3-4, 4-3, 4-4, 4-8
 console 4-2
 Control Relay 4-3
 CUL 4-2

D

D-Box 1-3, 3-4, 4-2, 4-5
 De-energizing 4-2
 DEF 1-5, 4-2, 5-2, 5-8

E

E85 1-5, 5-8

Eclipse 1-1, 4-6
 electric, electrical, electricity 4-3,
 4-4, 5-1
 electrical 4-1
 electrician 4-1
 Electronic leak detectors 4-8
 Emerald Book 4-8
 Emergency 5-9
 emergency stop 4-2
 Encore 1-1, 3-1, 4-2, 4-6, 5-8
 equipment security 3-3
 E-STOP 4-2
 Explosiveness 5-9
 Exxon 5-6

F

Fade-resistant 5-9
 Flexible fuels 5-1

G

gasoline 4-5
 GFI 3-4
 GFI breakers 4-2
 Green Book 4-8
 ground 4-1, 4-4, 4-8
 Group C 4-4
 G-SITE 4-5

H

Hazards 4-1
 HDPE 5-2
 High-speed 4-7

I

IEEE 4-8
 Intercom 4-4
 isolation relay 4-3

J

J-box 4-3, 4-4, 4-8

K

Killark 4-4, 4-10
 Kiosk 3-1
 Knock-out box 4-4

L

lights 4-1
 local codes 5-6
 Locks 3-3
 LRE 1-3

M

Model 52 5-1
 Morrison 5-6, 5-8
 MSDS 1-5
 MTW 1-3, 4-5

N

N23274 5-8
 NEC 4-2, 4-4, 4-7
 NFPA 30 4-4
 NFPA 30A 1-5, 4-1, 5-6, 5-7
 NFPA 70 4-4, 4-8

O

oil-resistant 4-5

P

PA0133 4-5
 PA0242 4-5
 PA0287 4-3
 PA0306 4-5
 PA0409 4-5
 PAM 3-4, 4-2
 PEI publication 5-6
 pipe 5-3
 pipe, plumbing 5-3, 5-4, 5-5, 5-6, 5-7
 Pit Box 3-4
 plumb 3-1, 5-1
 POS 3-3, 3-4, 4-5
 Potting 3-4
 Programming 3-3
 PUMP STOP 4-2
 Pump/dispenser 1-5
 PVC 4-5

Q

Q13221-2 4-5

R

Relay control boxes 4-8

Retrofits 1-5
RFID 4-2
routing 3-1
RP200 5-6

S

sealing compound 4-10
Section 36A 4-7
security measures 3-3
Service Center 1-1
shear section 5-6
shear valve 3-4, 5-3, 5-6, 5-7, 5-8
Shut-off Valve 3-4
Single Poppet Male Top 5-6
Stainless Steel Grade SS 304 5-4
Standard 87 4-7
state regulatory agencies 5-6
Station management 3-3
Station Security 3-3

storage tanks 5-6
Store 3-1
STP 1-2, 3-4, 4-1, 4-2, 4-3, 4-8
strainer 5-8
strainer housing 5-6
Sulfur 1-4

T

Technical Support 1-1
TFFN 1-4, 4-5
Three-phase 4-1
Transac 4-5
Twisted-pair 4-4, 4-5
Two-wire 4-4, 4-5

U

UL 3-4, 4-7, 5-2
UL/CUL 4-2
Ultra-Hi 3-1, 5-5

Underwriters' Laboratories 1-4
Universal D-Box 4-5
Unshielded 1-4
UTP 4-5

V

vapor recovery lines 5-6

W

WAGO 3-4
wiring, electrical 3-1, 3-4, 4-3, 4-4

Cisco® is a registered trademark of Cisco Systems Inc. Ethernet® is a registered trademark of Xerox Corporation. Exxon® is a registered trademark of Exxon Mobil Corporation. Killark® is a registered trademark of Killark Electrical Manufacturing Company. NEC® and NFPA 70® are registered trademarks of the National Fire Protection Association. OPW® is a registered trademark of OPW Fuel Management Systems. UL® is a registered trademark of Underwriters Laboratories Inc. WAGO® is a registered trademark of WAGO Corporation.

