

# Installation Manual

## Splice Kit Instructions

For Veeder-Root Probes and Sensors

Manual Number 576013-861, Revision C

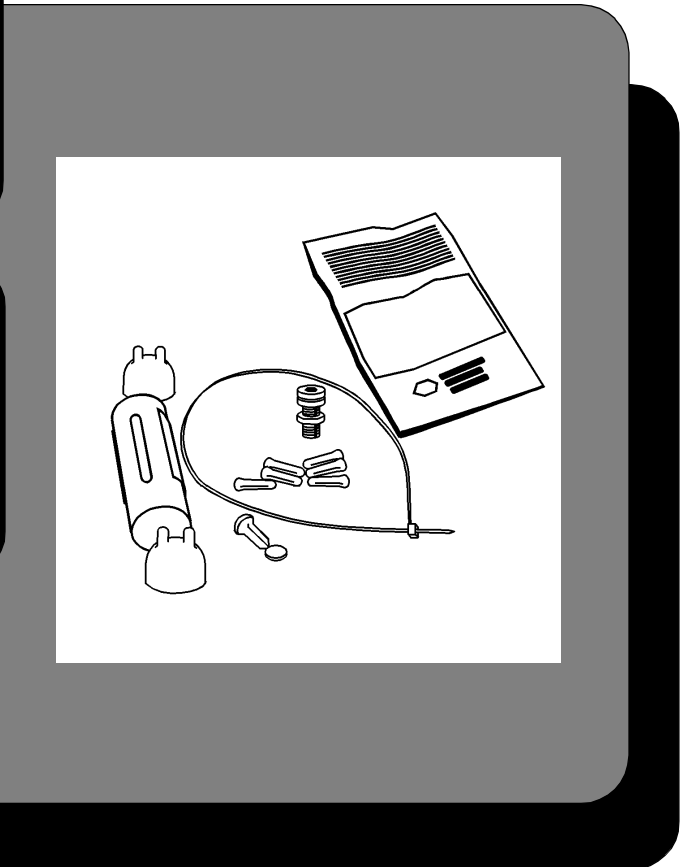
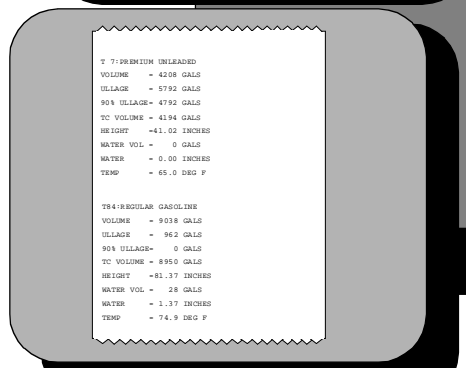
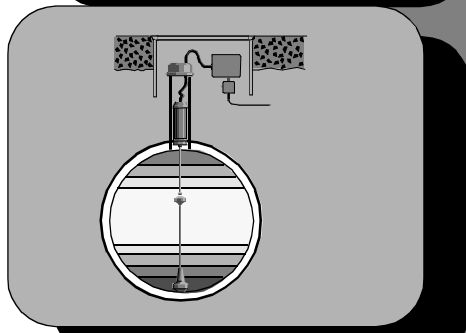
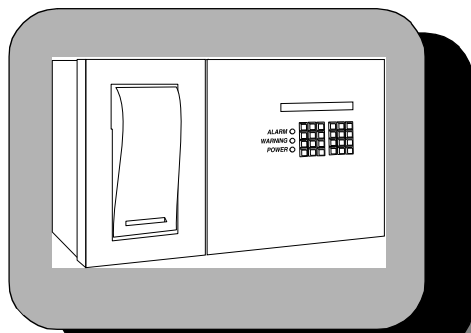

# Notice

---

Veeder-Root makes no warranty of any kind with regard to this publication, including, but not limited to, the implied warranties of merchantability and fitness for a particular purpose.

Veeder-Root shall not be liable for errors contained herein or for incidental or consequential damages in connection with the furnishing, performance, or use of this publication.

This publication contains proprietary information which is protected by copyright. All rights reserved. No part of this publication may be photocopied, reproduced, or translated to another language without the prior written consent of Veeder-Root.

The information contained in this publication is subject to change without notice.

## FCC Information

---

This equipment complies with the requirements in Part 15 of the FCC rules for a Class A computing device. Operation of this equipment in a residential area may cause unacceptable interference to radio and TV reception requiring the operator to take whatever steps are necessary to correct the interference.

© Veeder-Root 1996. All rights reserved.

# Reader Comment Card

Please take a moment to review this manual. Your comments will help us improve our manuals. *Thank you!*

Please circle one number for each.	Strongly Agree	Agree	Neutral	Disagree	Strongly Disagree
This manual contains the information I need.	5	4	3	2	1
This manual is well organized.	5	4	3	2	1
Layout and format of the manual make it easy to use.	5	4	3	2	1
Instructions are easy to understand.	5	4	3	2	1
Instructions are complete.	5	4	3	2	1
Illustrations are clear and helpful.	5	4	3	2	1
There are enough illustrations.	5	4	3	2	1
Manual meets my expectations.	5	4	3	2	1
Things I would like to see added:					
Write additional comments. Please be specific.					

577013-339, Revision B

Manual Name	Manual Title
Your Name	Your Title
Company	
Address	
City/State/Zip	Phone

**Mail to:**  
 Technical Publications Dept.  
 Veeder-Root  
 P.O. Box 2003  
 Simsbury, CT 06070-2003  
**Or fax to:**  
 (860) 651-2719  
 Attn: Technical Publications Dept.





# Veeder-Root Support



---

## Calling for Help

---

Please use these telephone numbers when you need help:

<b>Customer Service</b>	
Orders, accessories and supplies, customer support assistance, nearest authorized Veeder-Root distributor	 800-873-3313  800-234-5350
<i>Monday - Friday, 8 a.m. - 6 p.m. Eastern Standard Time</i>	

<b>Product Information</b>	
Literature requests Sales applications information Technical applications information	 800-873-3313  800-234-5350
<i>Monday - Friday, 8 a.m. - 4:30 p.m. Eastern Standard Time</i>	

<b>Technical Support (for Authorized Contractors only)</b>	
Technical Service	 860-651-2753
<i>Monday - Friday, 8 a.m. - 7 p.m. Eastern Standard Time</i>	



# Contents

---

## **Veeder-Root Support**

Calling for Help .....i

## **Introduction**

Safety Symbols .....1  
Warnings and Important Notes .....3  
Splice Kit Contents .....4  
Using the Splice Kit .....4

## **Warranty Conditions and Limitations of Liability**

Limitations Of Liability .....11  
Inspection .....11  
Limitation of Remedy and Warranty .....11  
Limitation of Damages .....12  
Limitation of Actions .....12  
Collateral Promises .....12  
Interpretation .....12

## Figures

Figure 1.	Splice Kit Contents .....	4
Figure 2.	Splice Length Dimensions .....	5
Figure 3.	Splice Closure/Cable Diagram—Probe and 2-Wire Sensor....	6
Figure 4.	Splice Closure/Cable Diagram—Probe and 3-Wire Sensor....	6
Figure 5.	Probe Cable Splice .....	7
Figure 6.	Q Compound, Clip Removal .....	8
Figure 7.	Pouring Q Compound .....	9
Figure 8.	Direct Burial Splice with Cable.....	9
Figure 9.	Field Wiring Diagram .....	10



# Introduction

---

This manual contains installation procedures for Splice Kit, Part Number 514100-357, designed and manufactured for Veeder-Root. This Splice Kit is needed for every probe or sensor installed with a Direct Burial Cable.

If this is a new installation and site preparation is necessary, refer to the appropriate Site Preparation and Installation Instructions or contact your Veeder-Root representative.

## Safety Symbols

---

The following safety symbols may be used throughout this manual to alert you to important safety hazards and precautions.



**Explosive**

Fuels and their vapors are extremely explosive if ignited.



**Flammable**

Fuels and their vapors are extremely flammable.



**Electricity**

High voltage exists in, and is supplied to, the device. A potential shock hazard exists.



**Turn Power Off**

Live power to a device creates a potential shock hazard. Always turn power off to the device and associated accessories when servicing the unit.



**No Smoking**

Sparks and embers from burning cigarettes or pipes can ignite fuels and their vapors



**No Open Flames**

Open flames from matches, lighters, welding torches, etc. can ignite fuels and their vapors.



**No Power Tools**

Sparks from power tools (such as drills) can ignite fuels and their vapors.

**No Vehicles**

Moving vehicles in the area during service can create a potential for personal injury to you or others. Sparks from starting vehicles can ignite fuels and their vapors

**Vehicular Danger**

Serious injury or death could result if you are struck by a vehicle.

**No People in the Area**

Unauthorized people in the area during service can create a potential for personal injury to you and them.

**Use Safety Barricades**

Unauthorized people or vehicles in the work area are dangerous. Always use safety cones or barricades, safety tape, and your vehicle to block the work area.

**Wear Eye Protection**

Fuel spray from residual pressure in the lines can cause serious eye injuries. Always wear eye protection.

**Injury**

Careless or improper handling of materials can result in bodily injury.



**Gloves**

Wear chemically resistant gloves to protect hands from irritation or injury.

**Read All Related Manuals**

Knowledge of all related procedures before you begin work is important. Read and understand all manuals thoroughly. If you do not understand a procedure, ask someone who does.

## Warnings and Important Notes

 <b>WARNING</b>	
	<p>This product is to be installed in systems operating near locations where highly combustible fuels or vapors may be present.</p> <p>Fire or explosion resulting in serious injury or death could result if the equipment is improperly installed or modified. Serious contamination of the environment may also occur.</p> <ol style="list-style-type: none"><li>1. Read and follow all instructions in this manual, including all safety warnings.</li><li>2. Comply with all applicable codes including: the National Electrical Code; federal, state, and local codes; and other applicable safety codes.</li><li>3. Do not alter or modify any component or substitute components in this kit.</li><li>4. Use this component only with Veeder-Root TLS-350 or TLS-350R systems. Install only as described in this manual.</li><li>5. Follow all safety warnings pertaining to installation of the probe or sensor requiring use of this Splice Kit.</li></ol>

**Important**  Failure to install this product in accordance with its instructions and warnings will result in voiding of all warranties connected with this product.

To help ensure proper installation and unit performance, we recommend that a Veeder-Root Authorized Service Contractor install this equipment.

## Splice Kit Contents

See Figure -1 to identify the parts for making splices:

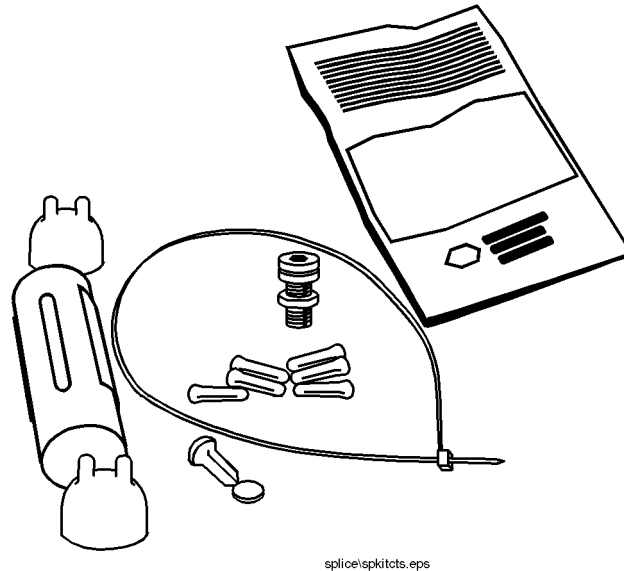
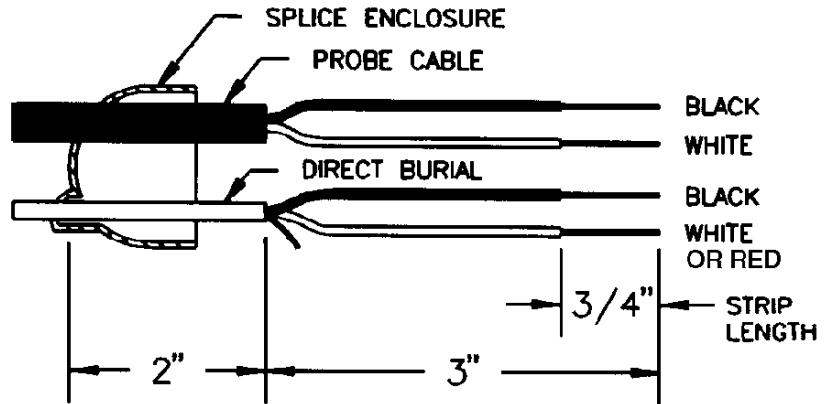

**Figure 1.** Splice Kit Contents

## Using the Splice Kit

To use the Splice Kit:

1. Insert the probe cable or sensor cable through the top of each riser cap and through the cable bushing.
2. If the Direct Burial Cable is entering from a sump wall, insert the Direct Burial Cable through the cable bushing supplied in the Splice Kit (see the Direct Burial Cable Installation Instructions manual for more information).
3. Cut the soft vinyl end cap entrance hole to accommodate each cable diameter. Keep the hole size to a minimum. Insert about 5 inches of cable through the opening [Figure 2 on page 5].



splice\lngthdim.eps

**Figure 2.** Splice Length Dimensions

4. Remove 3 inches of the outer jacket from each cable. Trim the insulation from the conductors [Figure -2].
5. Make the connections using wire nuts [Figure -3] for a 2-wire sensor or probe. Cut off the bare shield wire.

**Important** ☞ *Normally the drain wire is not connected to probes and sensors in the sump area. At the other end (conduit entry point), the drain wire must be spliced to a wire connected to a bonding screw inside the console. This connection effectively ties the direct burial cable shield to console ground.*

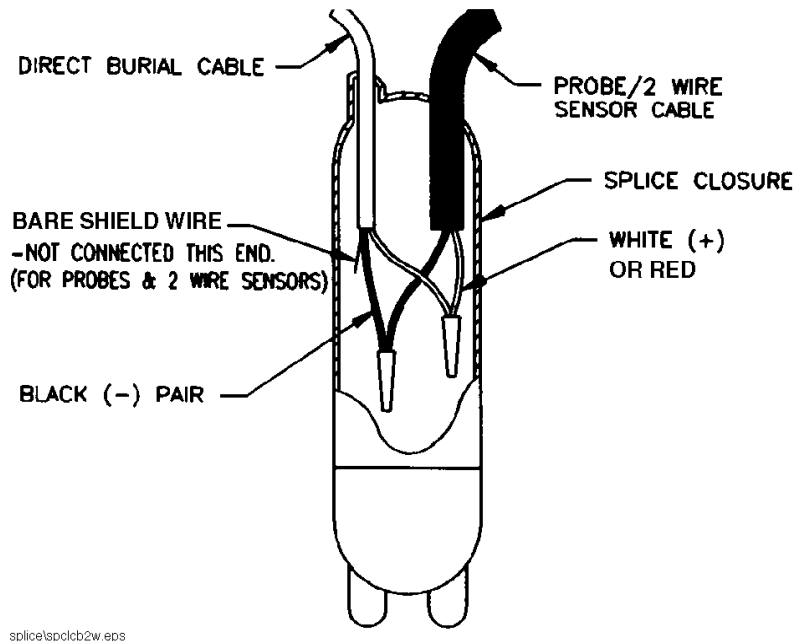

**Figure 3.** Splice Closure/Cable Diagram—Probe and 2-Wire Sensor

For the 3-wire sensors, see Figure -4 and Table 1. Make the connections according to sensor type, as shown in Table 1.

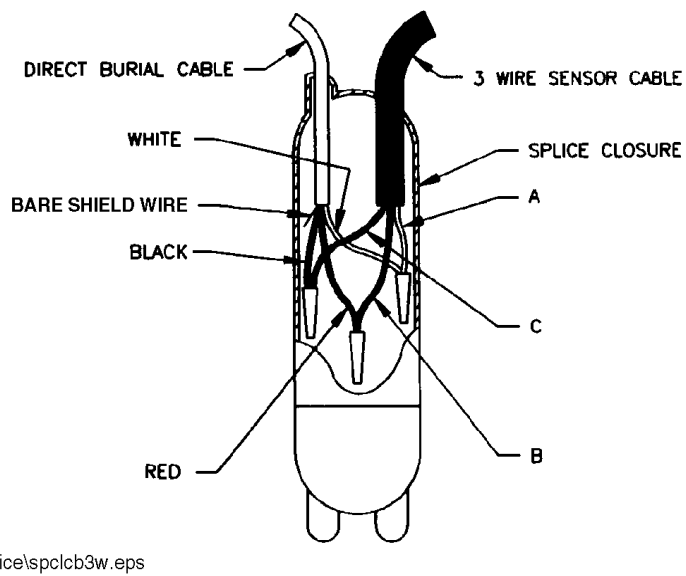
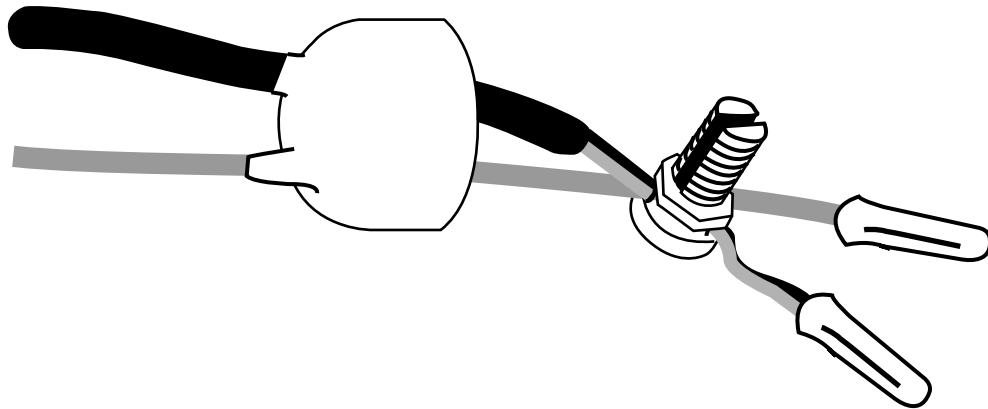

**Figure 4.** Splice Closure/Cable Diagram—Probe and 3-Wire Sensor

**Table 1:** Connection Table for 3-Wire Sensors

Shielded Cable Wire	Connection Reference	Vapor Sensor	Signal Name
white	A	white	water
red	B	black	vapor
black	C	green	ground
Shielded Cable Wire	Connection Reference	Ground Water Sensor	Signal Name
white	A	white	water
red	B	red	fuel
black	C	black	ground
Shielded Cable Wire	Connection Reference	Type B Sensor	Signal Name
white	A	white	A
red	B	red	B
black	C	black	ground

6. Use the aluminum bonding clamp to hold the direct burial and probe/sensor cables together [Figure -5]. Finger tighten, being careful not to damage the conductor insulation. This clamp is not intended to make any electrical connections.



splice\prbcbspl.eps

**Figure 5.** Probe Cable Splice

7. Center the splice in the clear plastic sleeve. Assemble the splice closure, making sure the sleeve is fully inserted into each of the vinyl end caps. Rotate the sleeve cover until both openings line up. Place the splice on a level surface.

**! CAUTION**

Q-compound and epoxy sealant may be irritating to skin and eyes, absorbed through the skin, or cause skin sensitization in susceptible individuals.



Minor injury may result. Also materials contained in epoxy have caused skin cancer in animal tests.

You must wear gloves that are chemically resistant.



Avoid skin and eye contact. Wear appropriate safety equipment. Use only in well ventilated areas. If exposed, wash affected skin areas with soap and water. For eye contamination, flush with water for 15 minutes and get immediate medical attention. For ingestion, if conscious give plenty of water and induce vomiting.

8. Remove bag of "Q-compound" from foil package. Grasp the ends, one in each hand, then pull sharply to remove plastic clip [Figure -6].

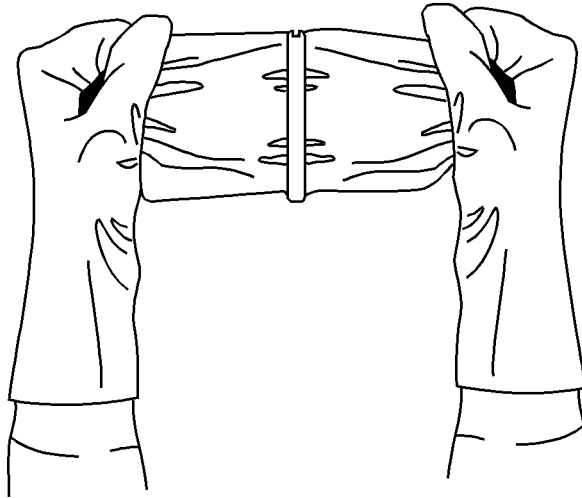
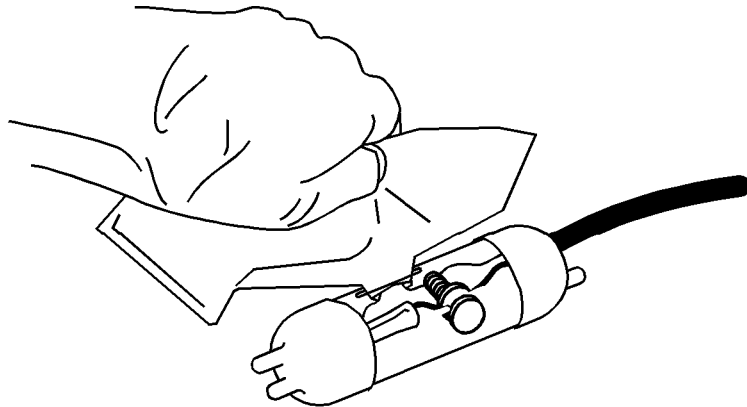

**Figure 6.** Q Compound, Clip Removal

9. Thoroughly mix compound together. Invert bag several times while squeezing compound from one end to the other for a minimum of one minute.



10. Once the mixture feels warm, immediately cut one corner and slowly fill the plastic sleeve. Stop just short of filling the entire sleeve. **Do not overfill.** [Figure - 7]



**Figure 7.** Pouring Q Compound

11. With a twisting motion, rotate the outer clear plastic barrel to close the pouring slot.
12. Wait at least five minutes, then use the large cable tie to mount the splice to the riser pipe [Figure -8].

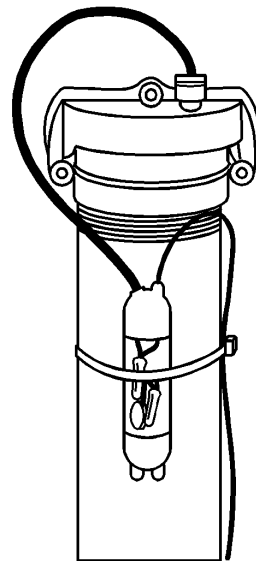

splicekitbrspw0 eps

**Figure 8.** Direct Burial Splice with Cable

13. Make the console connections at the entry point into the hazardous location. Refer to Figure -9 for making field wiring connections. Use wire nuts provided with Splice Kit to make these connections.

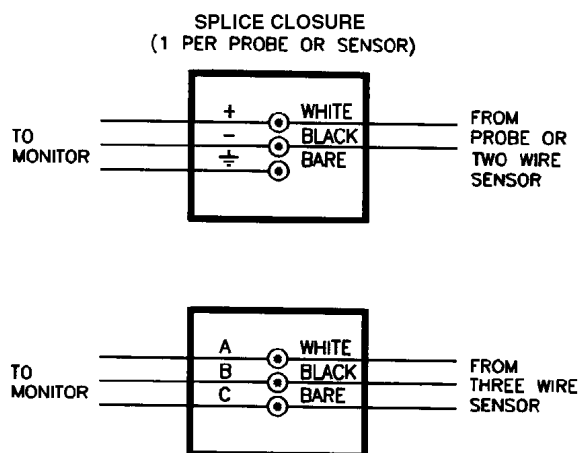

**Figure 9.** Field Wiring Diagram

14. Splice the Direct Burial Cables using the Splice Kit for all probes and sensors. Use the console to verify wiring, connections, probe and sensor operation. Do NOT proceed until the entire system is communicating with every probe and sensor.
15. **There must be no paths for gases to pass from the Hazardous Location to the Non-Hazardous Location.** To ensure water-tight seals, tighten all probe and sensor cable bushing nuts. Pour and check all seals in accordance with the National Electrical Code (NFPA 70) and the Automotive and Marine Service Station Code (NFPA 30A) since they pass from a Class I, Division I or Division II area into a non-hazardous area.

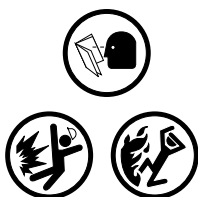

**Important**

*Using cables or sealants other than those described in this manual will void the product warranty. For sealing the trench, the only acceptable sealant is the 890-SL (self-leveling) from Dow Corning.*

*Sealant and epoxy are not interchangeable. Do not use epoxy for sealing buried cables and do not use sealant for potting wire nuts. The sealant, 890-SL, is dark gray, and packaged in cartridges and cans. The epoxy, Q Compound, is clear and packaged in a foil package.*

# Warranty Conditions and Limitations of Liability

---

## Limitations Of Liability

---

We warrant that this product will be free from defects in materials and workmanship for a period of 1 year from the date of installation or 15 months from the date of invoice, whichever occurs first. We will repair or replace the product if it is returned to us, transportation prepaid, within the warranty period and is determined by us to be defective.

We shall not be responsible for any expenses incurred by the user.

This warranty applies only when the product is installed in accordance with Veeder-Root's specifications. This warranty will not apply to any product which has been subjected to misuse, negligence or accident; or misapplied; or used in violation of product manuals, instructions or warnings; or modified or repaired by unauthorized persons; or improperly installed.

## Inspection

---

You shall inspect the product promptly after receipt and shall notify us at our Simsbury office in writing of any claims, including claims of breach of warranty, within 30 days after you discover or should have discovered the facts upon which the claim is based. Your failure to give written notice of a claim within the time period shall be deemed to be a waiver of such claim.

## Limitation of Remedy and Warranty

---

The provisions of "Limitations Of Liability" on page 11 are our sole obligation and exclude all other remedies or warranties, express or implied, including warranties of MERCHANTABILITY and FITNESS FOR A PARTICULAR PURPOSE, whether or not purposes or specifications are described herein. We further disclaim any responsibility whatsoever to you or to any other person for injury to person or damage to or loss of property or value caused by any product which has been subjected to misuse, negligence, or accident; or misapplied; or used in violation of product manuals, instructions or warnings; or modified or repaired by unauthorized persons; or improperly installed.

## Limitation of Damages

---

Under no circumstances shall we be liable for any incidental, consequential or specific damages, losses or expenses arising from this contract or its performance or in connection with the use of, or inability to use, our product for any purpose whatsoever.

## Limitation of Actions

---

No action regardless of form arising out of this contract may be commenced more than 1 year after the cause of action has accrued, except an action for nonpayment.

## Collateral Promises

---

There are no representations, warranties, or conditions, express or implied, statutory or otherwise except those herein contained, and no agreement or waivers collateral hereto shall be binding on either party unless in writing and signed by you and accepted by us at our Simsbury office.

## Interpretation

---

Rights and liabilities arising out of any contract with us shall be determined under the Uniform Commercial Code as enacted in Connecticut.



## Sales Offices

Veeder-Root has offices around the world to serve you.

### Headquarters

Veeder-Root Company  
125 Powder Forest Drive  
Simsbury, CT 06070-2003 U.S.A.  
860-651-2700 FAX: (860) 651-2719 TECH SUPPORT (860) 651-2753

### England

Veeder-Root Environmental Systems Limited  
Hydrex House, Garden Road  
Richmond, Surrey TW9 4NR ENGLAND  
44-181-392-1355

### Brazil

Veeder-Root do BRASIL  
Rua ado Benatti, 92  
Caixa Postal 8343  
01051 Sao Paulo BRAZIL  
55-11-861-2155

### Germany

Veeder-Root GmbH  
Umlandstrasse 49  
D-78554 Aldingen GERMANY  
49 (0)7424 89285

### France

Veeder-Root SARL  
ZI des Mardelles  
94-106 rue Blaise Pascal  
93600 Aulnay-sous-Bois FRANCE  
33 (0)1 4879 5599

### Canada

Veeder-Root Canada  
151 Superior Boulevard, Suite 24  
Mississauga, Ontario, L5T 2L1 CANADA  
905-670-2755

### Singapore

Veeder-Root Singapore  
#2 Kallang Pudding Road  
#06-16 Mactech Industrial Building  
SINGAPORE 1334  
(65) 745-0368 FAX: (65) 745-0636

### Mexico

Veeder-Root Mexico  
Prado de las Camelias  
No. 4483-4  
Praddos Tepeyac C.P. 45500  
Zapopan, Jal., MEXICO  
(52) 36-47-3750